

DILLON
CONSULTING

1027458 ONTARIO INC.

North Neighbourhood Subdivision
Comprehensive Transportation Impact Study

Table of Contents

1.0	Introduction	1
1.1	Purpose.....	1
1.2	Proposed Development.....	1
1.3	Scope of Analyses.....	2
2.0	Existing (2022) Conditions	3
2.1	Existing Transportation Network Characteristics.....	3
2.2	Existing Alternative Transportation Facilities	5
2.2.1	Transit Services	6
2.3	Traffic Data Collection	8
2.3.1	Volume Adjustments.....	8
2.4	Existing (2022) Traffic Volumes.....	9
2.5	Existing (2022) Operational Analyses.....	10
3.0	Future Background Conditions	12
3.1	Background Developments.....	12
3.1.1	Riverside Sportsmen Residential Development.....	12
3.1.2	Ganatchio Gardens Residential Development	13
3.1.3	VGA Residential Development.....	14
3.1.4	Phase 1, Phase 2 and Phase 4 of the North Neighbourhood Subdivision	14
3.1.5	Background Developments Summary	15
3.2	Background Growth	16
3.3	Future Background Traffic Volumes	17
3.3.1	Future Background (2027) Traffic Volumes	17
3.3.2	Future Background (2032) Traffic Volumes	18
3.4	Future Background Operational Analyses	19
3.4.1	Future Background (2027) Intersection Operations	19
3.4.2	Future Background (2032) Intersection Operations	20

4.0	Proposed Residential Subdivision	22
	4.1 Trip Distribution	22
	4.2 Phase 3.....	23
	4.2.1 Phase 3 Trip Generation	23
	4.2.2 Phase 3 Vehicle Trip Assignment	23
	4.3 Phase 5.....	24
	4.3.1 Phase 5 Trip Generation	24
	4.3.2 Phase 5 Vehicle Trip Assignment	25
	4.4 Phase 6.....	25
	4.4.1 Phase 6 Trip Generation	25
	4.4.2 Phase 6 Vehicle Trip Assignment	26
	4.5 Phase 7.....	26
	4.5.1 Phase 7 Trip Generation	27
	4.5.2 Phase 7 Vehicle Trip Assignment	27
	4.6 Summary.....	28
	4.6.1 Trip Generation	28
	4.6.2 Site-Generated Vehicle Trips	28
	4.7 Non-Auto Travel	30
5.0	Total Future Conditions	31
	5.1 Redistribution and Reassignment	31
	5.1.1 Clover Avenue and Florence Avenue Extensions.....	31
	5.2 Total Future Traffic Volumes.....	35
	5.2.1 Total Future (2027) Traffic Volumes.....	36
	5.2.2 Total Future (2032) Traffic Volumes.....	37
	5.3 Total Future Operational Analyses.....	38
	5.3.1 Total Future (2027) Intersection Operations	38
	5.3.2 Total Future (2032) Intersection Operations	40
	5.4 Potential Traffic Control along Wyandotte Street.....	41
	5.5 Potential Laning along Clover Avenue and Florence Avenue	42

6.0	Internal Traffic Control	44
7.0	Summary	45

Figures

Figure 1: 'North Neighbourhood Subdivision' Masterplan.....	1
Figure 2: Existing Laning and Traffic Control	5
Figure 3: Lauzon 10 Bus Routing Surrounding the Study Area	7
Figure 4: Existing (2022) Traffic Volumes	9
Figure 5: Background Developments Summary.....	16
Figure 6: Future Background (2027) Traffic Volumes	17
Figure 7: Future Background (2032) Traffic Volumes	18
Figure 8: Site-Generated Trips (Phases 3, 5, 6, 7)	29
Figure 9: Additional Induced Traffic Volumes on Clover Avenue and Florence Avenue.....	34
Figure 10: Total Future (2027) Traffic Volumes.....	36
Figure 11: Total Future (2032) Traffic Volumes.....	37
Figure 12: Recommended Internal Traffic Control	44

Tables

Table 1: Traffic Data Collection.....	8
Table 2: Existing (2022) Intersection Operations.....	10
Table 3: Trip Generation – Riverside Sportsmen Residential Development	13
Table 4: Trip Generation – Ganatchio Gardens Residential Development	13
Table 5: Trip Generation – VGA Residential Development	14
Table 6: Trip Generation – Phase 1, Phase 2 and Phase 4, North Neighbourhood Subdivision.....	15
Table 7: Future Background (2027) Intersection Operations.....	19
Table 8: Future Background (2032) Intersection Operations.....	20
Table 9: Overall Trip Distribution.....	23
Table 10: Trip Generation – Phase 3	23
Table 11: Trip Assignment – Phase 3.....	24
Table 12: Trip Generation – Phase 5	24
Table 13: Trip Assignment – Phase 5.....	25
Table 14: Trip Generation – Phase 6	26
Table 15: Trip Assignment – Phase 6.....	26
Table 16: Trip Generation – Phase 7	27

Table 17: Trip Assignment – Phase 7.....	27
Table 18: Trip Generation Summary	28
Table 19: Projected Site Development Modal Split	30
Table 20: Induced Traffic Volumes along Florence Avenue and Clover Avenue	33
Table 21: Total Future (2027) Intersection Operations.....	38
Table 22: Total Future (2032) Intersection Operations.....	40
Table 23: Total Future (2032) Intersection Operations With Removal of the Induced Volumes	41
Table 24: Total Future (2032) Intersection Operations With Added Left-Turn Lanes	42

Appendices

- A Conceptual Development Plan
- B Traffic Volume Data
- C Level of Service (LOS) Definitions
- D Synchro Analysis Worksheets

1.0 Introduction

1.1 Purpose

Dillon Consulting Limited (Dillon) has been retained by 1027458 Ontario Inc., (the “client”) to undertake a comprehensive transportation impact study (TIS) which reviews the impact of several phases as proposed within the ‘North Neighbourhood Subdivision’ located in the city of Windsor, Ontario and found within lands in the East Riverside Secondary Plan area. This proposed residential subdivision would be located on vacant lands found south of Wyandotte Street East and east of Florence Avenue.

This report documents the anticipated change to traffic volumes and intersection operations associated with the proposed subdivision and identifies any modification to traffic controls or infrastructure that may be necessary to mitigate the impacts from the additional traffic.

1.2 Proposed Development

The proposed ‘North Neighbourhood Subdivision’ is located to the south of Wyandotte Street East, east of Florence Avenue and north of Beverly Glen Street. Figure 1 illustrates the ‘North Neighbourhood Subdivision’ masterplan, and a larger version can be found in Appendix A.

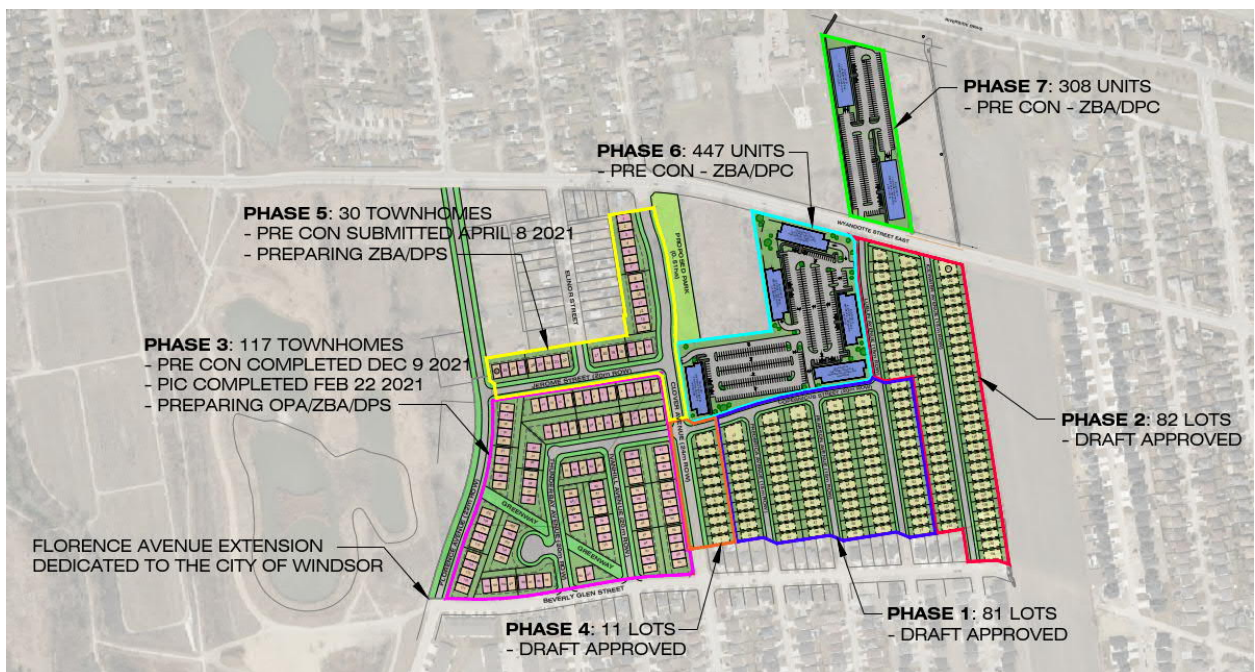

Figure 1: 'North Neighbourhood Subdivision' Masterplan

Several phases of the residential subdivision are already approved. This includes Phase 1, Phase 2, and Phase 4. Further information on these phases of the subdivision can be found in Section 3.1.4. Instead,

this comprehensive transportation impact study focuses on Phase 3, Phase 5, Phase 6 and Phase 7 of the subject subdivision which have not yet been formally approved.

Phase 3 includes 117 townhome dwelling units and is located on the northeast corner of the Florence Avenue and Beverly Glen Street intersection. Phase 5 includes 30 townhome dwelling units and is located to the immediate north of Phase 3. Phase 6 includes 447 apartment dwelling units in five (5) apartment buildings found on the southwest corner of the future Wyandotte Street East and Lublin Avenue intersection. Phase 7 includes 308 apartment dwelling units in two (2) apartment buildings to the immediate north of the future Wyandotte Street East and Lublin Avenue intersection.

Within these phases of the subject subdivision, both Clover Avenue and Florence Avenue would be extended south of Wyandotte Street East. In both cases, these corridors would connect to the existing roadways found south of Beverly Glen Street.

1.3 Scope of Analyses

The report documents the following:

- Existing traffic volumes, and traffic projections for the study area intersections and accesses;
- Intersection capacity analyses under existing conditions, future background conditions, and total future conditions;
- Existing transit and active transportation facilities near the site; and
- Future mode-shares and non-auto trips that may be generated by the site.

Traffic data collection, forecasts and operational analyses have been completed at:

- Wyandotte Street East and Florence Avenue (unsignalized);
- Wyandotte Street East and Clover Avenue (unsignalized);
- McHugh Street and Florence Avenue (unsignalized); and
- Clover Avenue and Little River Boulevard (unsignalized).

An existing single-detached house has a driveway which utilizes the south leg of the Wyandotte Street East and Clover Avenue intersection. As a result, there is only a minor amount of traffic currently using the south leg of the intersection.

Traffic projections and intersection analyses were completed for the weekday AM, PM, and Saturday mid-day peak hours. Each phase of the proposed residential subdivision is anticipated to be fully built-out by 2027 and for the purposes of analysis, Therefore, within this report and associated analyses, the final horizon year has been identified as 2032 (five years following the complete build-out).

2.0

Existing (2022) Conditions

2.1

Existing Transportation Network Characteristics

The following describes the existing road network in the immediate study area:

Wyandotte Street East is an east-west Class II Arterial Road that is under the jurisdiction of the City of Windsor. The roadway runs across the City of Windsor from Huron Church Road (Wyandotte Street West) to Banwell Road (Wyandotte Street East). Within the study area, Wyandotte Street East features a two-lane cross-section (one lane per direction), sidewalks on both sides of the road, and bicycle lanes in both directions. Within the study area, the posted speed limit is 50 km/h.

Florence Avenue is a north-south local road that is under the jurisdiction of the City of Windsor. Currently, Florence Avenue is divided into two road sections. The north section extends north of Wyandotte Street East to Riverside Drive East, and the south section extends north of McHugh Street to Beverly Glen Street. The north section within the study area features a two-lane cross-section, a sidewalk on the west side of the road, and on-street parking permitted on the east side of the road between Wyandotte Street East and Menard Street. The south section within the study area features a two-lane cross-section, sidewalks along both sides of the road, and a multi-use path that runs parallel with the roadway. As no speed limit signage is present along either section of the road, the speed limit would default to the statutory limit of 50 km/h.

Clover Avenue is a north-south Class I Collector Road that is under the jurisdiction of the City of Windsor. Currently, Clover Avenue is divided into two road sections. The north section extends north of Wyandotte Street East to Riverside Drive East, and the south section extends north of McHugh Street to Beverly Glen Street. The north section within the study area features a two-lane cross-section, sidewalks along both sides of the road, and on-street parking permitted on both sides of the road between Wyandotte Street East and Clairview Avenue. The south section within the study area features a two-lane cross-section, sidewalks along both sides of the road, and permitted on-street parking on the east side of the road. As no speed limit signage is present along either section of the road, the speed limit would default to the statutory limit of 50 km/h.

McHugh Street is an east-west Class II Arterial Road that is under the jurisdiction of the City of Windsor. The roadway runs east of Lauzon Parkway/Lauzon Road to the west of Banwell Road before turning into McNorton Street. Within the study area, McHugh Street features a four-lane cross-section (two lanes per direction), a multi-use path on the north side of the road, and a sidewalk found on some parts of the road. The posted speed limit is 50 km/h.

Little River Boulevard is an east-west Class I Collector Road that is under the jurisdiction of the City of Windsor. The road extends east from Florence Avenue to Lesperance Road in the town of Tecumseh. Within the study area, Little River Boulevard features a two-lane cross-section, east of Clover Avenue, on-street parking is permitted on both sides of the road, and west of Clover Avenue, on-street parking is permitted on the north side of the road. A sidewalk is present on the north side of the road, and a multi-use path is along the south side of the road. As no speed limit signage is present, the speed limit would default to the statutory limit of 50 km/h.

Beverly Glen Street is an east-west local road that is under the jurisdiction of the City of Windsor. The road extends east from Florence Avenue to Icewater Avenue with a future connection anticipated to connect to the road network further to the east. Within the study area, Beverly Glen Street features a two-lane cross-section, with on-street parking and a sidewalk on the south side of the road. As no speed limit signage is present, the speed limit would default to the statutory limit of 50 km/h.

Figure 2 illustrates the existing lane configurations and traffic controls at the four existing study area intersections.

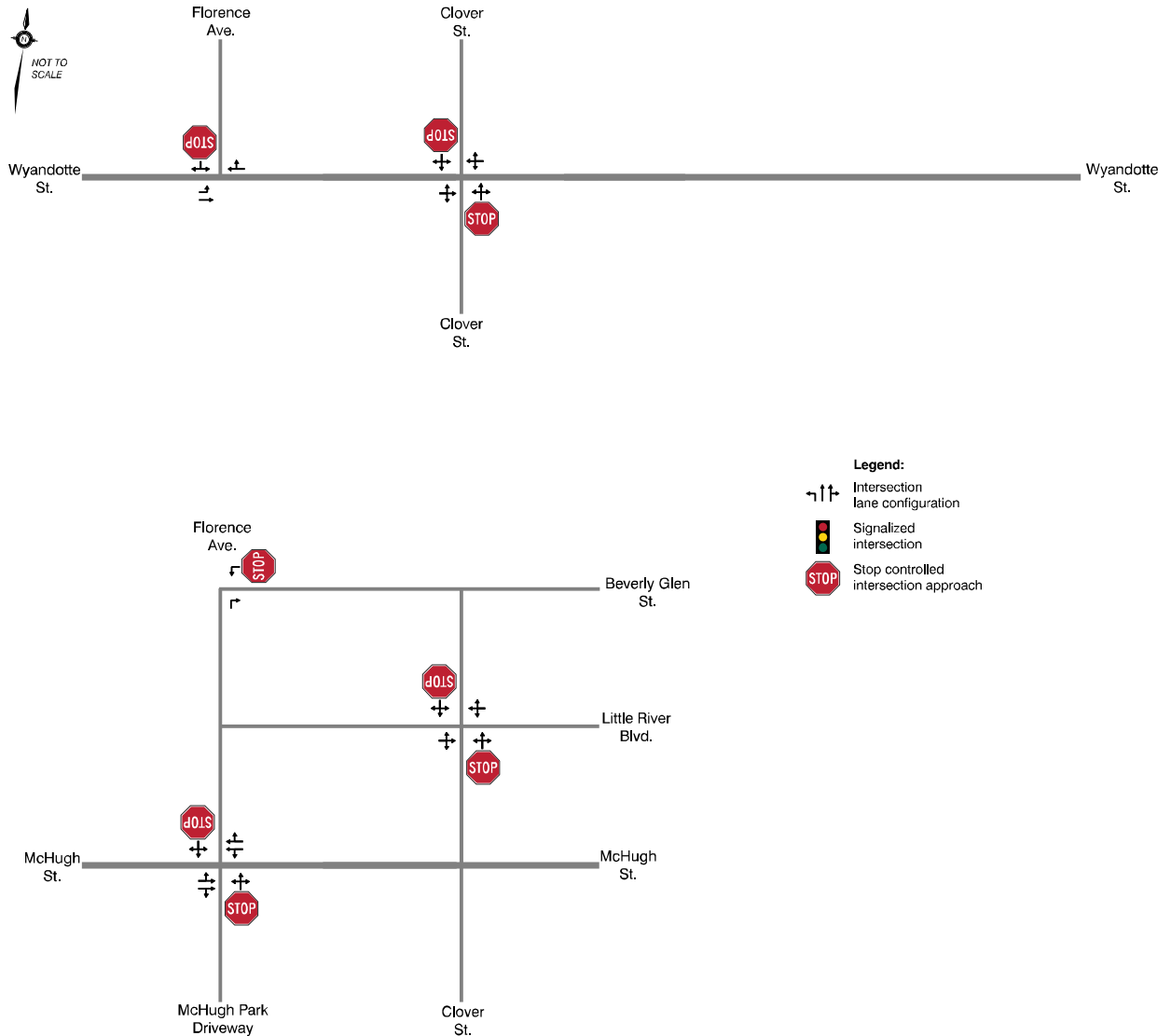

Figure 2: Existing Laning and Traffic Control

2.2 Existing Alternative Transportation Facilities

Active transportation facilities, as well as public transit service, currently exist in the study area. A summary of these facilities is noted below.

Wyandotte Street East: Within the study area, sidewalks and bicycle lanes exist on both sides of the road. A multi-use path, the Ganatchio Trail, runs north-south, crossing Wyandotte Street East to the west of Florence Avenue and extends south, crossing McHugh Street to the west of Florence Avenue.

Florence Avenue: For the north section, within the study area, a sidewalk exists on the west side of the road. For the south section, sidewalks exist on both sides of the road. North of Little River Boulevard, a multi-use path is located along the west side that connects to the Ganatchio Trail, and south of Little River Boulevard, a multi-use path is located along the west side of the road.

Clover Avenue: For the north section, within the study area, sidewalks exist on both sides of the road starting approximately 60 metres north of Wyandotte Street East. No sidewalks are present to the immediate north of Wyandotte Street East. For the south section, sidewalks exist on both sides of the road.

McHugh Street: Within the study area, a sidewalk exists on the south side of the road starting at the east McHugh Park driveway and extends east. A multi-use path connects to the Ganatchio Trail, existing on the north side of the road.

Little River Boulevard: Within the study area, a sidewalk exists on the north side of the road and a multi-use path exists on the south side of the road.

Beverly Glen Street: Within the study area, a sidewalk exists on the south side of the road, and the Ganatchio Trail is located west of Florence Avenue and Beverly Glen Street intersection.

2.2.1 Transit Services

Lauzon 10

Within the study area, the Lauzon 10 route travels northbound on Clover Avenue between McHugh Street and Little River Boulevard, eastbound along Little River Boulevard east of Clover Avenue and westbound along Wyandotte Street East. The route travels through east Windsor, and originates at the Tecumseh Mall Terminal. At the Tecumseh Mall Terminal, connections to the Transway 1C, the Crosstown 2, and the Ottawa 4 bus routes can be made. On weekdays and during the AM, PM, and evening peak hours, the route frequency operates every 35 minutes while on Saturdays, the Lauzon 10 transit route operates every 70 minutes. The Lauzon 10 transit route does not provide Sunday or Holiday service.

Figure 3 shows the routing of Lauzon 10 transit route sourced from Transit Windsor's website¹.

¹ <https://www.citywindsor.ca/residents/transitwindsor/Routes-and-Schedules/Documents/fall-schedule/Lauzon10.pdf>

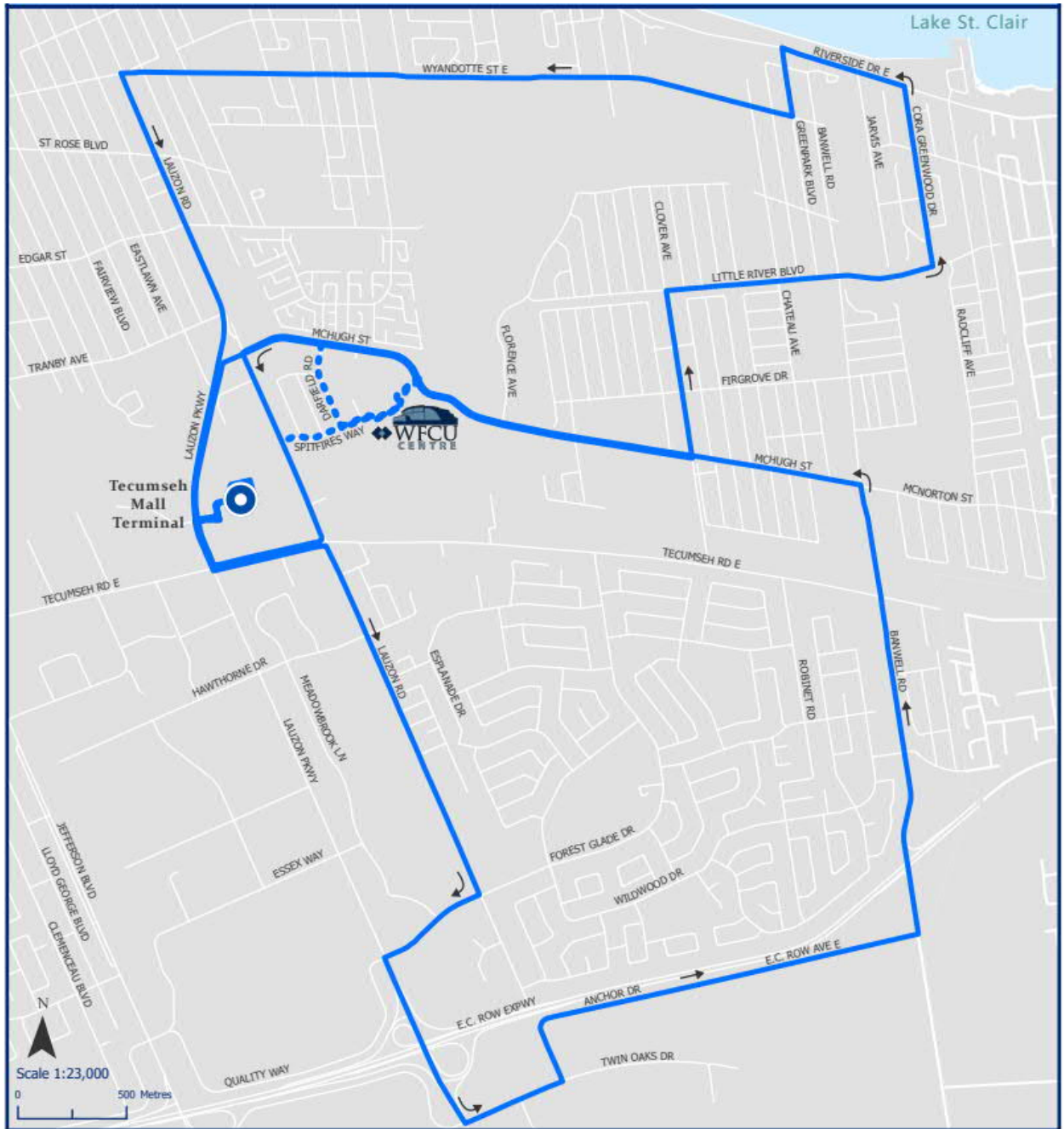

Figure 3: Lauzon 10 Bus Routing Surrounding the Study Area

2.3

Traffic Data Collection

Turning movement count (TMC) data was collected by Dillon in the field in both February and September 2022. The TMC data can be found in Appendix B.

TMC data was collected at the following locations:

- Wyandotte Street East and Florence Avenue (unsignalized);
- Wyandotte Street East and Clover Avenue (unsignalized);
- McHugh Street and Florence Avenue (unsignalized); and
- Clover Avenue and Little River Boulevard (unsignalized).

The data collected was inclusive of the following periods:

- Weekday mornings between 7:00 AM and 10:00 AM;
- Weekday afternoon between 3:00 PM and 6:00 PM; and
- Saturday mid-day between 12:00 PM and 3:00 PM.

Table 1 identifies the dates when the field traffic counts were performed.

Table 1: Traffic Data Collection

Intersection	Weekday AM Period	Weekday PM Period	Saturday
Wyandotte Street East and Florence Avenue	Wednesday, February 16, 2022	Wednesday, February 16, 2022	February 19, 2022
Wyandotte Street East and Clover Avenue	Wednesday, February 16, 2022	Wednesday, February 16, 2022	February 19, 2022
McHugh Street and Florence Avenue	Thursday, September 15, 2022	Thursday, September 15, 2022	September 17, 2022
Clover Avenue and Little River Boulevard	Thursday, September 15, 2022	Thursday, September 15, 2022	September 17, 2022

2.3.1

Volume Adjustments

Even though the traffic data was collected in 2022 and during the ongoing COVID-19 pandemic, the collected traffic data is believed to be representative of typical peak hour volumes in the area. As such, no adjustments were made to the collected traffic data to compensate for pandemic conditions.

2.4 Existing (2022) Traffic Volumes

Figure 4 illustrates the existing (2022) traffic volumes at the four study area intersections during the weekday AM, PM, and Saturday mid-day peak hours. Traffic volumes were rounded to the nearest five (5) vehicles.

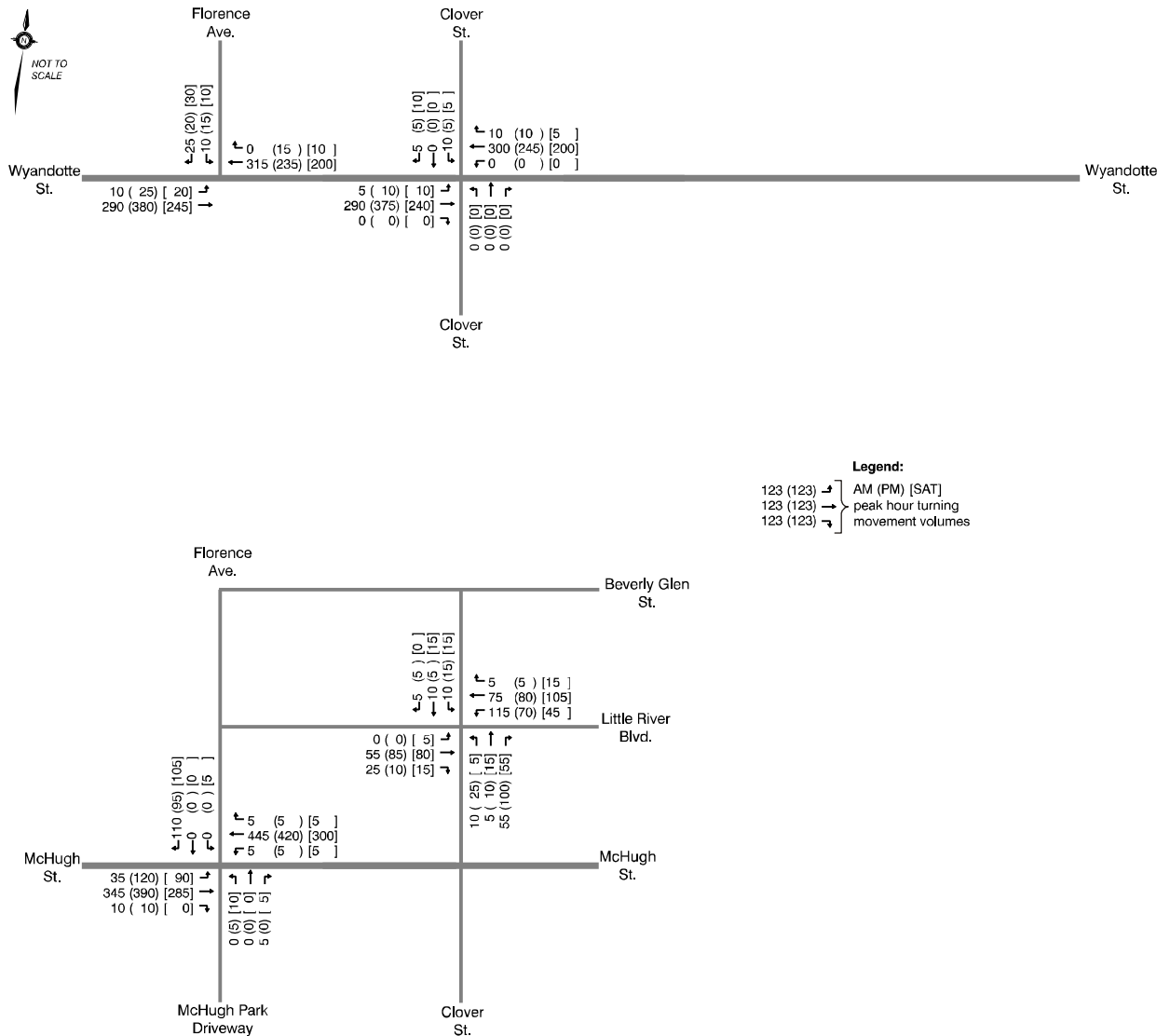

Figure 4: Existing (2022) Traffic Volumes

Existing (2022) Operational Analyses

Existing (2022) peak hour operations were determined based on the methodology outlined in the Highway Capacity Manual (HCM) and facilitated using Synchro (version 10) analysis software. The intersection analyses are based on existing lane configurations.

For each movement, the volume-to-capacity ratio, level of service, average delay and 95th percentile queue were noted. The level of service definitions are provided in Appendix C. The Synchro analysis worksheets are provided in Appendix D. The results were reviewed to identify any critical movements, defined as follows:

- Any through lane/movement with a v/c ratio of 0.85 or higher;
- Any exclusive turning lane/movement with a v/c ratio of 1.00 or higher;
- Any movement operating at LOS E or LOS F; and/or
- Any turning movement with a 95th percentile queue exceeding the available storage.

Table 2 summarizes the intersection operations under existing (2022) peak hour traffic volumes.

Table 2: Existing (2022) Intersection Operations

Intersection	Movement	Weekday AM Peak Hour				Weekday PM Peak Hour				Saturday Mid-day Peak Hour			
		v/c	LOS	Delay (s/veh)	95th %ile queue (m)	v/c	LOS	Delay (s/veh)	95th %ile queue (m)	v/c	LOS	Delay (s/veh)	95th %ile queue (m)
Wyandotte Street East and Florence Avenue	EBL	0.01	A	8.0	0	0.02	A	7.8	1	0.02	A	7.7	0
	SBLR	0.07	B	11.6	2	0.07	B	12.2	2	0.06	B	10.4	2
Wyandotte Street East and Clover Avenue	NBLTR	0.00	A	0.0	0	0.00	A	0.0	0	0.00	A	0.0	0
	SBLTR	0.04	B	13.5	1	0.02	B	12.6	1	0.02	B	10.5	1
McHugh Street and Florence Avenue	SBLR	0.16	B	10.7	5	0.13	B	10.4	4	0.15	B	10.4	4
Little River Boulevard and Clover Avenue	NBLTR	0.09	A	9.9	3	0.18	B	10.4	5	0.10	A	9.9	3
	SBLTR	0.05	B	12.5	1	0.05	B	12.5	1	0.06	B	12.2	2

Under existing (2022) conditions, the four intersections within the study area operate in a good manner. All stop-controlled approaches during the weekday AM, weekday PM, and Saturday mid-day peak hours operate at LOS B or better.

3.0

Future Background Conditions

The future background traffic volumes reflect the volume of traffic that is anticipated to be on the road network during both the 2027 and 2032 horizon years without the subject development in place.

Typically, this is comprised of two components:

- The application of site-specific traffic volumes for any background developments near the site; and
- The application of a growth rate to reflect general background traffic growth on the road network.

3.1

Background Developments

Given the location of the proposed subdivision it has been confirmed that a number of background developments are in the midst of being planned and constructed within and close to the study area. As a result, four (4) separate background developments were identified, noting that one background development is for three phases of this subject subdivision that have already been approved.

The four (4) background developments included:

- The Riverside Sportsmen residential development found northeast of the Clover Avenue and Wyandotte Street East intersection:
 - This residential development proposes the construction of three apartment buildings with a total of 184 dwelling units.
- The Ganatchio Gardens residential development found on the southwest corner of the Florence Avenue and Wyandotte Street East intersection:
 - This residential development proposes the construction of two apartment buildings containing 128 dwelling units each as well as 28 townhome units (284 total residential dwelling units).
- The VGA residential development found on the southeast corner of the Florence Street and Wyandotte Street East intersection:
 - This residential development proposes the construction of a single four (4) storey apartment building with 15 dwelling units.
- Phase 1, Phase 2 and Phase 4 of the subject subdivision as they have been already approved:
 - Phase 1 includes 81 single-family dwellings.
 - Phase 2 includes 82 single family dwellings.
 - Phase 4 includes 11 single family dwellings.

3.1.1

Riverside Sportsmen Residential Development

A new residential development is underway to the immediate south of the existing Riverside Sportsmen facility which is found at 10835 Riverside Drive East. This site is located northeast of the Clover Avenue and Wyandotte Street East intersection and proposes three apartment buildings with a total of 184 dwelling units.

Table 3 summarizes the number of vehicle trips that are projected to be generated by the proposed apartment buildings located on the Riverside Sportsmen parcel. Given the nature of this background development, ITE Land Use code 221 – Multifamily Housing (Mid-Rise) was used.

Table 3: Trip Generation – Riverside Sportsmen Residential Development

	Weekday AM Peak Hour			Weekday PM Peak Hour			Saturday Peak Hour		
	In	Out	Total	In	Out	Total	In	Out	Total
Three Apartment Buildings (184 units) – ITE Land Use Code 221									
In/Out/Rate	23%	77%	0.37	61%	39%	0.39	51%	49%	0.39
Total Trips	16	52	68	44	28	72	37	35	72

The proposed Riverside Sportsmen residential development is projected to generate 68 vehicle trips during the AM peak hour and 72 vehicle trips during the PM and Saturday peak hours.

3.1.2

Ganatchio Gardens Residential Development

In June 2022, Dillon completed a transportation impact study to support a proposed residential development found on the southwest corner of the Wyandotte Street East and Florence Street intersection. This proposed residential development envisions the construction of two (2) 16-storey residential apartment buildings with 256 dwelling units. In addition, 28 townhome units are proposed.

Table 4 summarizes the number of vehicle trips that are projected to be generated by the proposed Ganatchio Gardens residential development. Within the completed TIS, ITE Land Use code 215 – Single-Family Attached Housing and ITE Land Use code 222 – Multifamily Housing (High-Rise) were used.

Table 4: Trip Generation – Ganatchio Gardens Residential Development

	Weekday AM Peak Hour			Weekday PM Peak Hour			Saturday Peak Hour		
	In	Out	Total	In	Out	Total	In	Out	Total
Two Apartment Buildings (256 dwelling units) – ITE Land Use Code 222									
In/Out/Rate	34%	66%	0.27	56%	44%	0.32	57%	43%	0.36
Vehicle Trips	23	46	69	46	36	82	52	40	92
Townhouse Dwellings (28 dwelling units) – ITE Land Use Code 215									
In/Out/Rate	31%	69%	0.48	57%	43%	0.57	48%	52%	0.57
Vehicle Trips	4	9	13	9	7	16	8	8	16
Total Trips	27	55	82	55	43	98	60	48	108

The proposed Ganatchio Gardens residential development is projected to generate 82 vehicle trips in the AM peak hour, 98 vehicle trips in the PM peak hour, and 108 vehicle trips during the Saturday mid-day peak hour.

3.1.3 VGA Residential Development

A small residential development is proposed on the southeast corner of the Wyandotte Street East and Florence Avenue intersection. Here, the construction of a single four (4) storey apartment building with 15 dwelling units is proposed.

Table 5 summarizes the number of vehicle trips that are projected to be generated by the proposed VGA residential development. Given the nature of this background development, ITE Land Use code 220 – Multifamily Housing (Low-Rise) was used.

Table 5: Trip Generation – VGA Residential Development

	Weekday AM Peak Hour			Weekday PM Peak Hour			Saturday Peak Hour		
	In	Out	Total	In	Out	Total	In	Out	Total
One Apartment Building (15 units) – ITE Land Use Code 220									
In/Out/Rate	24%	76%	0.40	63%	37%	0.51	50%	50%	0.41
Total Trips	1	5	6	5	3	8	3	3	6

The proposed VGA residential development is projected to generate 6 vehicle trips in the AM and Saturday peak hours and 8 vehicle trips in the PM peak hour.

3.1.4 Phase 1, Phase 2 and Phase 4 of the North Neighbourhood Subdivision

As noted previously, several phases of this subject 'North Neighbourhood Subdivision' have been previously approved and are anticipated to be constructed within the next several years. This includes Phase 1, Phase 2 and Phase 4. Each of these three phases only include single detached homes. Phase 1 includes 81 single detached homes, Phase 2 includes 82 single detached homes while Phase 4 includes 11 single detached homes.

Several road network changes will be introduced as part of the approved phases. For example, both Lublin Avenue and Icewater Avenue will be connected between Little River Boulevard and Wyandotte Street East.

Table 6 summarizes the number of vehicle trips that are projected to be generated by these approved phases of the subject subdivision. Since the land use is the same for all three phases, ITE Land Use code 210 – Single Family Detached Housing was utilized.

Table 6: Trip Generation – Phase 1, Phase 2 and Phase 4, North Neighbourhood Subdivision

	Weekday AM Peak Hour			Weekday PM Peak Hour			Saturday Peak Hour		
	In	Out	Total	In	Out	Total	In	Out	Total
Single Family Detached Housing (174 homes) – ITE Land Use Code 210									
In/Out/Rate	26%	74%	0.70	63%	37%	0.94	54%	46%	0.92
Phase 1	15	42	57	48	28	76	41	34	75
Phase 2	15	42	57	49	28	77	41	34	75
Phase 4	2	6	8	6	4	10	5	5	10
Total Trips	32	90	122	103	60	163	87	73	160

Phase 1, Phase 2 and Phase 4 have been calculated to generate 122 vehicle trips during the AM peak hour, 163 vehicle trips during the PM peak hour and 160 vehicle trips during the Saturday peak hour.

3.1.5**Background Developments Summary**

The future vehicle trips that would be generated by each of these four residential background developments were included within the future background traffic volumes for both the 2027 and 2032 horizon years.

Figure 5 shows how these trips were distributed and assigned by these four background through the study area. Given the majority of these background developments were close to the Wyandotte Street East corridor, the majority of trips were distributed and assigned along this corridor.

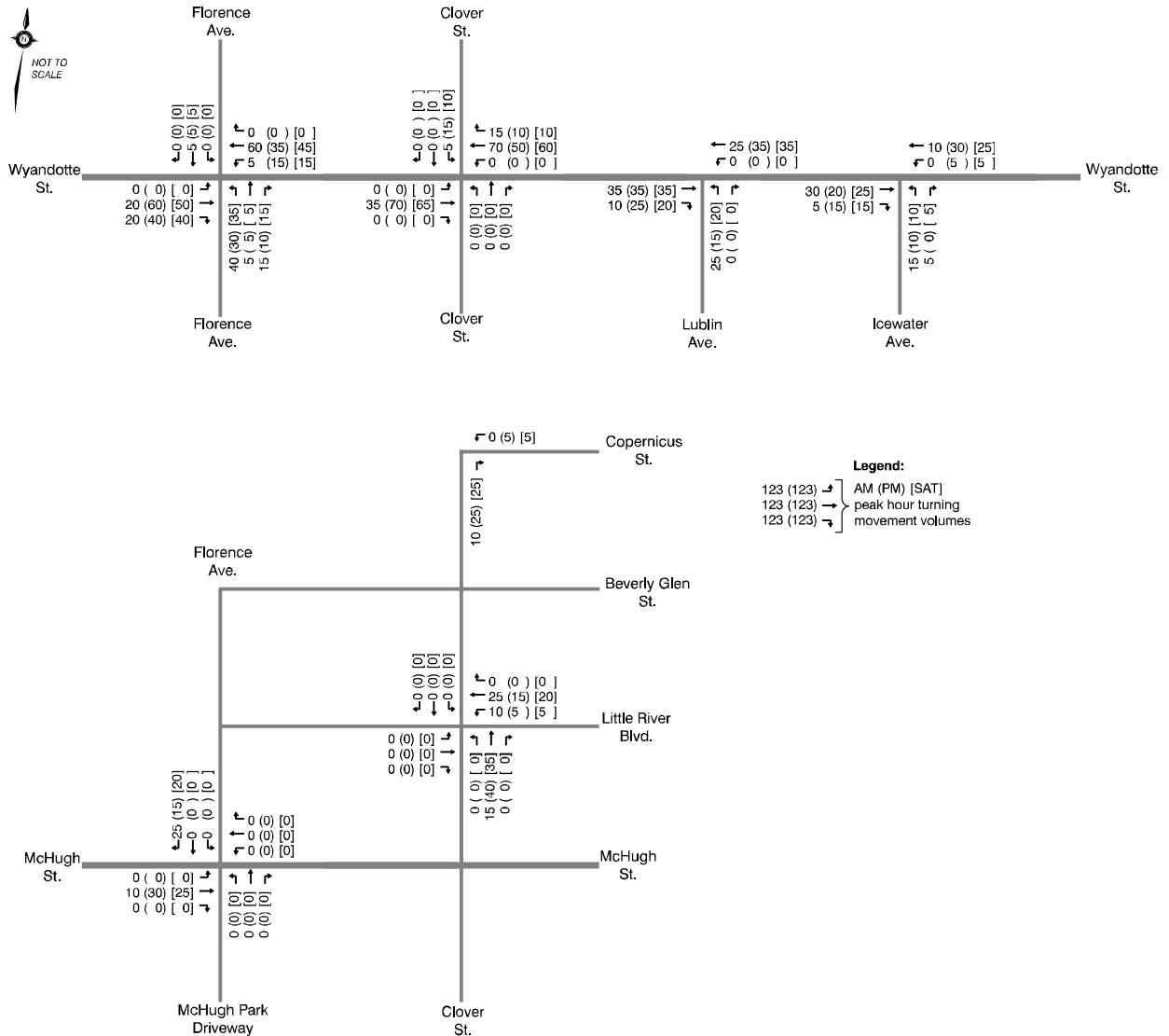

Figure 5: Background Developments Summary

3.2 Background Growth

As for traffic growth that would not be associated with a specific development, Dillon reviewed a city-wide historical traffic growth rate chart of the relative traffic volumes from 1967 to 2017. It was observed that the City of Windsor’s relative traffic growth has been decreasing or stagnant within the past 15 years (2002 – 2017). However, given the time forecast between the base year (2022) and the final horizon year (2032), and considering the size, scope and location of the subject development, a 1.0% per annum background growth rate has been applied to the collected traffic movements at each intersection located within the study area.

3.3 Future Background Traffic Volumes

Given Phase 1 and 2 of the subject residential development are anticipated to connect both Lublin Avenue and Icewater Avenue between Wyandotte Street East and Beverly Glen Street, it is anticipated that some existing traffic may travel along those subject corridors. However, other than the trips generated by the subject background developments, no existing traffic was redistributed or reassigned along these two corridors.

Further reassignment of traffic is discussed in Section 5.1.

3.3.1 Future Background (2027) Traffic Volumes

The future background (2027) traffic volumes are illustrated in Figure 6.

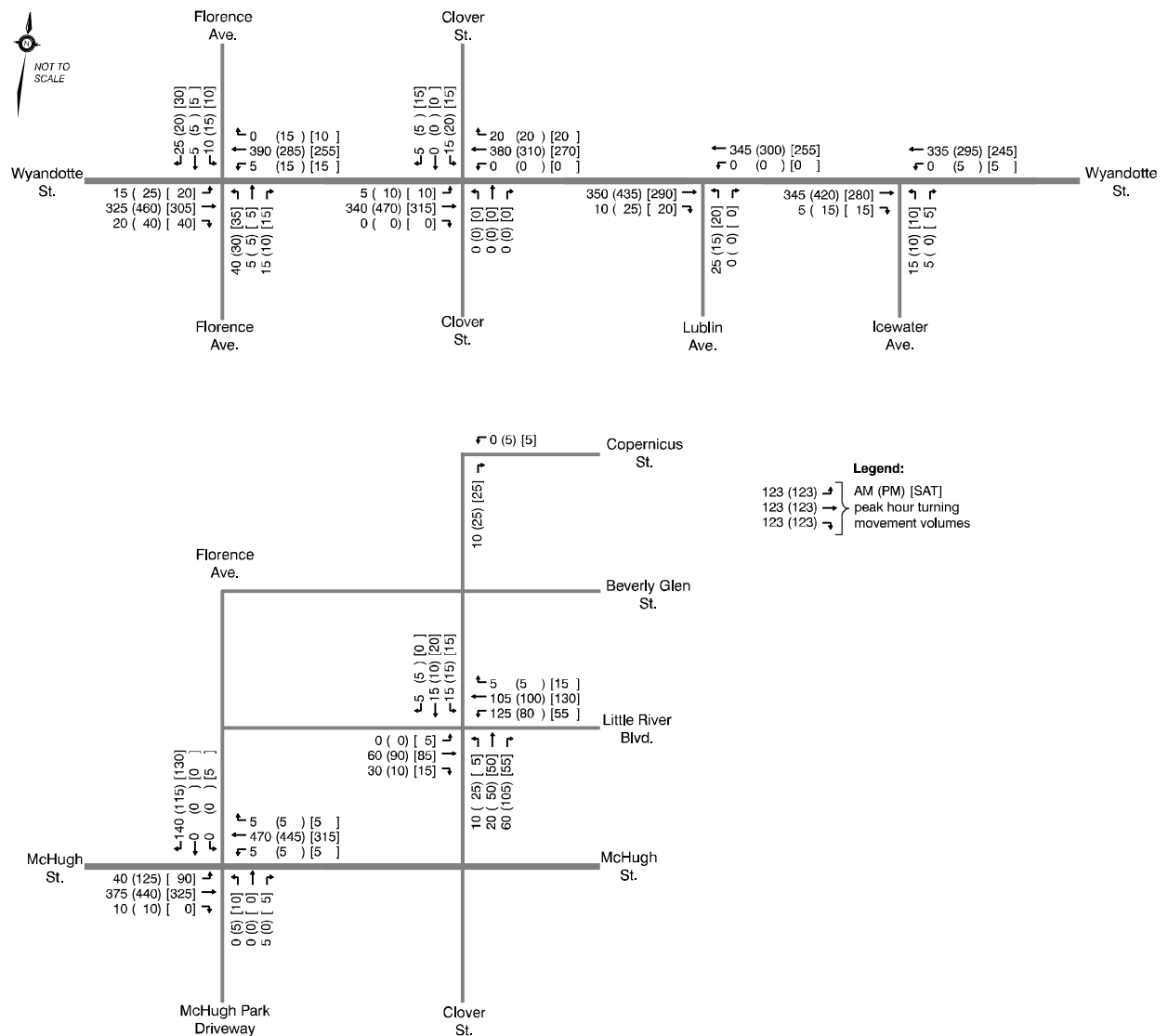
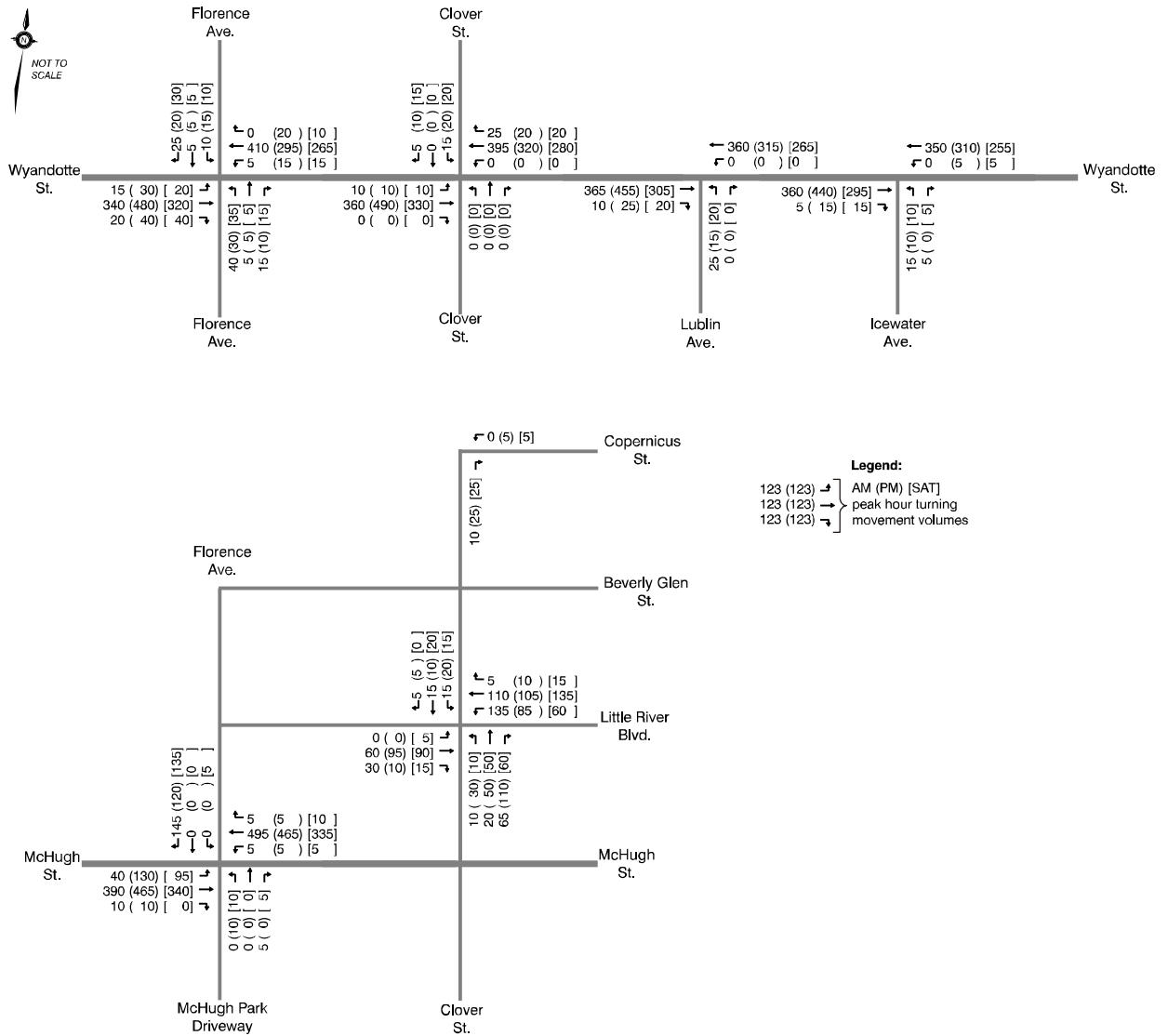

Figure 6: Future Background (2027) Traffic Volumes

3.3.2 Future Background (2032) Traffic Volumes

The future background (2032) traffic volumes are illustrated in Figure 7.



3.4

Future Background Operational Analyses

Future background intersection operations for both the 2027 and 2032 horizon year were assessed using the generally the same methodology as the existing conditions analysis. However, as two background developments are found along Florence Avenue to the immediate south of Wyandotte Street East, it has been assumed that the Florence Avenue and Wyandotte Street East intersection will ultimately include four approaches. In addition, it has been assumed that the westbound left-turn lane on Wyandotte Street East at Florence Avenue has been painted.

Since both Lublin Avenue and Icewater Avenue will be extended north to Wyandotte Street East as part of Phase 2, these two future intersections to Wyandotte Avenue East were also analyzed.

3.4.1

Future Background (2027) Intersection Operations

Table 7 summarizes the intersection operations under future background (2027) conditions.

Table 7: Future Background (2027) Intersection Operations

Intersection	Movement	Weekday AM Peak Hour				Weekday PM Peak Hour				Saturday Mid-day Peak Hour			
		v/c	LOS	Delay (s/veh)	95th %ile queue (m)	v/c	LOS	Delay (s/veh)	95th %ile queue (m)	v/c	LOS	Delay (s/veh)	95th %ile queue (m)
Wyandotte Street East and Florence Avenue	EBL	0.01	A	8.2	0	0.02	A	8.0	1	0.02	A	7.9	0
	WBL	0.00	A	8.1	0	0.02	A	8.6	0	0.01	A	8.1	0
	NBLTR	0.21	C	19.7	6	0.19	C	21.7	5	0.16	C	16.8	5
	SBLTR	0.10	B	14.3	3	0.12	C	16.2	3	0.09	B	12.4	2
Wyandotte Street East and Clover Avenue	NBLTR	0.00	A	0.0	0	0.00	A	0.0	0	0.00	A	0.0	0
	SBLTR	0.06	C	16.2	2	0.09	C	18.2	2	0.07	B	12.8	2
McHugh Street and Florence Avenue	SBLR	0.21	B	11.1	6	0.17	B	10.7	5	0.19	B	10.6	5
Little River Boulevard and Clover Avenue	NBLTR	0.14	B	11.0	4	0.28	B	12.1	9	0.18	B	11.4	5
	SBLTR	0.08	B	14.0	2	0.07	B	13.7	2	0.08	B	13.2	2
Wyandotte Street East and Lublin Avenue	NBLR	0.07	C	15.4	2	0.05	C	15.8	1	0.05	B	13.2	1

Intersection	Movement	Weekday AM Peak Hour				Weekday PM Peak Hour				Saturday Mid-day Peak Hour			
		v/c	LOS	Delay (s/veh)	95th %ile queue (m)	v/c	LOS	Delay (s/veh)	95th %ile queue (m)	v/c	LOS	Delay (s/veh)	95th %ile queue (m)
Wyandotte Street East and Icewater Avenue	NBLR	0.05	B	13.9	1	0.03	C	15.5	1	0.03	B	12.0	1

Compared to existing (2022) operations, the four existing and two future study area intersections are projected to continue operating in an acceptable manner. All stop-controlled approaches are anticipated to now operate at LOS C or better. Minimal delay and queuing is also projected at the six intersections during all three peak periods.

3.4.2 Future Background (2032) Intersection Operations

Table 8 summarizes the intersection operations under future background (2032) conditions.

Table 8: Future Background (2032) Intersection Operations

Intersection	Movement	Weekday AM Peak Hour				Weekday PM Peak Hour				Saturday Mid-day Peak Hour			
		v/c	LOS	Delay (s/veh)	95th %ile queue (m)	v/c	LOS	Delay (s/veh)	95th %ile queue (m)	v/c	LOS	Delay (s/veh)	95th %ile queue (m)
Wyandotte Street East and Florence Avenue	EBL	0.01	A	8.3	0	0.03	A	8.0	1	0.02	A	7.9	0
	WBL	0.00	A	8.1	0	0.02	A	8.6	0	0.01	A	8.1	0
	NBLTR	0.22	C	20.8	7	0.20	C	23.3	6	0.17	C	17.3	5
	SBLTR	0.10	B	14.8	3	0.13	C	17.0	3	0.09	B	12.7	3
Wyandotte Street East and Clover Avenue	NBLTR	0.00	A	0.0	0	0.00	A	0.0	0	0.00	A	0.0	0
	SBLTR	0.07	C	17.1	2	0.10	C	17.6	3	0.08	B	13.7	2
McHugh Street and Florence Avenue	SBLR	0.22	B	11.3	7	0.17	B	10.9	5	0.20	B	10.8	6
Little River Boulevard and Clover Avenue	NBLTR	0.15	B	11.1	4	0.30	B	12.5	10	0.20	B	11.8	6
	SBLTR	0.09	B	14.5	2	0.09	B	14.7	3	0.08	B	13.6	2

Intersection	Movement	Weekday AM Peak Hour				Weekday PM Peak Hour				Saturday Mid-day Peak Hour			
		v/c	LOS	Delay (s/veh)	95th %ile queue (m)	v/c	LOS	Delay (s/veh)	95th %ile queue (m)	v/c	LOS	Delay (s/veh)	95th %ile queue (m)
Wyandotte Street East and Lublin Avenue	NBLR	0.08	C	15.9	2	0.05	C	16.4	1	0.05	B	13.5	1
Wyandotte Street East and Icewater Avenue	NBLR	0.05	B	14.3	1	0.03	C	16.0	1	0.03	B	12.3	1

Compared to future background (2027) operations, the four existing and two future study area intersections are projected to continue operating in an acceptable manner. All stop-controlled approaches are anticipated to continue operating at LOS C or better. Minimal delay and queuing is once again projected at the six intersections.

4.0

Proposed Residential Subdivision

The proposed 'North Neighbourhood Subdivision' is located to the south of Wyandotte Street East, east of Florence Avenue and north of Beverly Glen Street and includes four separate phases that have not yet been approved. These four phases include:

- Phase 3, which includes 117 townhome dwelling units and would be located on the northeast corner of the Florence Avenue and Beverly Glen Street intersection;
- Phase 5, which includes 30 townhome dwelling units and would be located north of Phase 3;
- Phase 6, which includes 447 apartment dwelling units in five (5) apartment buildings located on the southwest quadrant of the Wyandotte Street East and Lublin Avenue intersection; and
- Phase 7, which includes 308 apartment dwelling units in two (2) apartment buildings and is located to the immediate north of the future Wyandotte Street East and Lublin Avenue intersection.

Both Clover Avenue and Florence Avenue would be extended south of Wyandotte Street East. In both cases, these streets would connect to the existing roadways found south of Beverly Glen Street and north of Wyandotte Street East. As a result, both these streets would ultimately extend from Riverside Drive West south to at least McHugh Street.

Given the subject subdivision is fully residential, no calculations for pass-by or for internal capture were undertaken.

4.1

Trip Distribution

The vehicle trips generated by the proposed residential subdivision were distributed to the road network based on travel and demographic characteristics published in the 2005 Essex-Windsor Regional Transportation Master Plan (EWRTMP). The EWRTMP included a geographic distribution of projected 2021 population and employment throughout the City of Windsor and County of Essex, as well as an estimate of the trips made in the Windsor-Essex region during the PM peak period according to the purpose of the trip (e.g., trips from work to home; trips from home to shopping, etc.).

Table 9 lists the trip distribution applied to the vehicle trips generated by each phase of the proposed subdivision within the study area, noting that trip assignments were calculated separately due to the location of each individual phase within the subject subdivision.

Table 9: Overall Trip Distribution

To/From:	Trip Distribution %
West: Wyandotte Street East/McHugh Street towards Lauzon Road	60%
East: Wyandotte Street East/Little River Boulevard/McHugh Street towards Banwell Road	20%
North: Florence Avenue/Clover Avenue towards Riverside Drive East	10%
South: Florence Avenue/Clover Avenue towards McHugh Street	10%
TOTAL	100%

4.2 Phase 3

Phase 3 includes 117 townhome dwelling units and is located on the northeast corner of the Florence Avenue and Beverly Glen Street intersection.

4.2.1 Phase 3 Trip Generation

The number of vehicle trips that are expected to be generated by Phase 3 of this residential subdivision was estimated based on trip generation rates published within the Institute of Transportation Engineers' document Trip Generation Manual (11th edition).

Table 10 summarizes the number of vehicle trips anticipated to be generated by Phase 3 during the AM, PM and Saturday mid-day peak hours. Given the nature of this phase, ITE Land Use Code 215 (Single-Family Attached Housing) was used.

Table 10: Trip Generation – Phase 3

	Weekday AM Peak Hour			Weekday PM Peak Hour			Saturday Mid-day Peak Hour		
	In	Out	Total	In	Out	Total	In	Out	Total
Single-Family Attached Dwellings – (117 units) – ITE Land Use Code 215									
In/Out/Rate	31%	69%	0.48	57%	43%	0.57	48%	52%	0.57
Vehicle Trips	17	39	56	38	29	67	32	35	67
Total Vehicle Trips	17	39	56	38	29	67	32	35	67

Phase 3 of the proposed residential subdivision is forecast to generate 56 vehicle trips (17 inbound, 39 outbound) in the AM peak hour, 67 vehicle trips (38 inbound, 29 outbound) in the PM peak hour and 67 vehicle trips (32 inbound, 35 outbound) during the Saturday mid-day peak hour.

4.2.2 Phase 3 Vehicle Trip Assignment

Given the layout and location of Phase 3 within the subject subdivision, the site trips will have numerous opportunities to travel both in and out of the study area. Table 11 lists the trip assignment applied to the vehicle trips generated by Phase 3 of the proposed subdivision within the study area.

Table 11: Trip Assignment – Phase 3

Trip Distribution	Trip Distribution %	Via:	Trip Assignment %
West	60%	Wyandotte Street East towards Lauzon Road	50%
		McHugh Street towards Lauzon Road	50%
East	20%	Wyandotte Street East towards Banwell Road	30%
		McHugh Street towards Banwell Road	20%
		Little River Boulevard towards Banwell Road	50%
North	10%	Florence Avenue towards Riverside Drive East	65%
		Clover Avenue towards Riverside Drive East	30%
		Elinor Street towards Riverside Drive East	5%
South	10%	Clover Avenue towards Tecumseh Road East	100%
TOTAL	100%	-	-

4.3 Phase 5

Phase 5 includes 30 townhome dwelling units and is located to the immediate north of Phase 3.

4.3.1 Phase 5 Trip Generation

Table 12 summarizes the number of vehicle trips anticipated to be generated by the 30 townhome units within Phase 5 during the AM, PM and Saturday mid-day peak hours. Given the nature of this phase, Land Use Code 215 (Single-Family Attached Housing) was used.

Table 12: Trip Generation – Phase 5

	Weekday AM Peak Hour			Weekday PM Peak Hour			Saturday Mid-day Peak Hour		
	In	Out	Total	In	Out	Total	In	Out	Total
Single-Family Attached units – (30 units) – ITE Land Use Code 215									
In/Out/Rate	31%	69%	0.48	57%	43%	0.57	48%	52%	0.57
Vehicle Trips	4	10	14	10	7	17	8	9	17
Total Vehicle Trips	4	10	14	10	7	17	8	9	17

Phase 5 of the proposed residential subdivision is forecast to generate 14 vehicle trips (4 inbound, 10 outbound) in the AM peak hour, 17 vehicle trips (10 inbound, 7 outbound) in the PM peak hour and 17 vehicle trips (8 inbound, 9 outbound) during the Saturday mid-day peak hour.

4.3.2 Phase 5 Vehicle Trip Assignment

Given the layout and location of Phase 5 within the subject subdivision, the site trips will have numerous opportunities to travel both in and out of the study area. Table 13 lists the trip assignment applied to the vehicle trips generated by Phase 5 of the proposed subdivision within the study area.

Table 13: Trip Assignment – Phase 5

Trip Distribution	Trip Distribution %	Via:	Trip Assignment %
West	60%	Wyandotte Street East towards Lauzon Road	75%
		McHugh Street towards Lauzon Road	25%
East	20%	Wyandotte Street East towards Banwell Road	30%
		McHugh Street towards Banwell Road	35%
		Little River Boulevard towards Banwell Road	35%
North	10%	Florence Avenue towards Riverside Drive East	35%
		Clover Avenue towards Riverside Drive East	60%
		Elinor Street towards Riverside Drive East	5%
South	10%	Clover Avenue towards Tecumseh Road East	100%
TOTAL	100%	-	-

4.4 Phase 6

Phase 6 includes 447 apartment dwelling units in five (5) apartment buildings found in the southwest quadrant of the Wyandotte Street East and Lublin Avenue intersection. Two of the buildings are proposed to be 12-storeys each with a total of 258 dwelling units while the remaining three buildings are proposed to be 6-storey each with a total of 189 dwelling units.

4.4.1 Phase 6 Trip Generation

Table 14 summarizes the number of vehicle trips anticipated to be generated by the 447 apartment units proposed within Phase 6 during the AM, PM and Saturday mid-day peak hours.

Given the nature of the proposed development, ITE Land Use Code 221 (Multifamily Housing (Mid-Rise)) was used for the three 6-storey buildings with 189 dwelling units while ITE Land Use Code 222 (Multifamily Housing (High-Rise)) was used for the two 12-storey buildings with 258 dwelling units.

Table 14: Trip Generation – Phase 6

	Weekday AM Peak Hour			Weekday PM Peak Hour			Saturday Mid-day Peak Hour		
	In	Out	Total	In	Out	Total	In	Out	Total
Three Multifamily Housing Buildings (Mid-Rise) - (189 dwelling units) – ITE Land Use Code 221									
In/Out/Rate	23%	77%	0.37	61%	39%	0.39	51%	49%	0.39
Vehicle Trips	16	54	70	45	29	74	38	36	74
Two Multifamily Housing Buildings (High-Rise) - (258 dwelling units) – ITE Land Use Code 222									
In/Out/Rate	34%	66%	0.27	56%	44%	0.32	57%	43%	0.36
Vehicle Trips	24	46	70	46	37	83	53	40	93
Total Vehicle Trips	40	100	140	91	66	157	91	76	167

Phase 6 of the proposed residential subdivision is forecast to generate 140 vehicle trips (40 inbound, 100 outbound) in the AM peak hour, 157 vehicle trips (91 inbound, 66 outbound) in the PM peak hour and 167 vehicle trips (91 inbound, 76 outbound) during the Saturday mid-day peak hour.

4.4.2 Phase 6 Vehicle Trip Assignment

Given the layout and location of Phase 6 within the subject subdivision, the site trips will have numerous opportunities to travel both in and out of the study area. Table 15 lists the trip assignment applied to the vehicle trips generated by Phase 6 of the proposed subdivision within the study area.

Table 15: Trip Assignment – Phase 6

Trip Distribution	Trip Distribution %	Via:	Trip Assignment %
West	60%	Wyandotte Street East towards Lauzon Road	50%
		McHugh Street towards Lauzon Road	50%
East	20%	Wyandotte Street East towards Banwell Road	30%
		McHugh Street towards Banwell Road	55%
		Little River Boulevard towards Banwell Road	15%
North	10%	Florence Avenue towards Riverside Drive East	0%
		Clover Avenue towards Riverside Drive East	100%
		Elinor Street towards Riverside Drive East	0%
South	10%	Clover Avenue towards Tecumseh Road East	100%
TOTAL	100%	-	-

4.5 Phase 7

Phase 7 includes 308 apartment dwelling units in two (2) apartment buildings. Both buildings are proposed to be 11-stories in height.

4.5.1

Phase 7 Trip Generation

Table 16 summarizes the number of vehicle trips anticipated to be generated by Phase 7 of the proposed residential development during the AM, PM and Saturday mid-day peak hours. ITE Land Use Code 222 (Multi-family Housing (High-Rise)) was used for the 308 apartment units.

Table 16: Trip Generation – Phase 7

	Weekday AM Peak Hour			Weekday PM Peak Hour			Saturday Mid-day Peak Hour		
	In	Out	Total	In	Out	Total	In	Out	Total
Two Multifamily Housing Buildings (High-Rise) - (256 dwelling units) – ITE Land Use Code 222									
In/Out/Rate	34%	66%	0.27	56%	44%	0.32	57%	43%	0.36
Vehicle Trips	28	55	83	55	44	99	63	48	111
Total Vehicle Trips	28	55	83	55	44	99	63	48	111

Phase 7 of the proposed development is forecast to generate 83 vehicle trips (28 inbound, 55 outbound) in the AM peak hour, 99 vehicle trips (55 inbound, 44 outbound) in the PM peak hour and 111 vehicle trips (63 inbound, 48 outbound) during the Saturday mid-day peak hour.

4.5.2

Phase 7 Vehicle Trip Assignment

Given the layout and location of Phase 7 within the subject subdivision, the site trips will have numerous opportunities to travel both in and out of the study area. Table 17 lists the trip assignment applied to the vehicle trips generated by Phase 7 of the proposed subdivision throughout the study area.

Table 17: Trip Assignment – Phase 7

Trip Distribution	Trip Distribution %	Via:	Trip Assignment %
West	60%	Wyandotte Street East towards Lauzon Road	75%
		McHugh Street towards Lauzon Road	25%
East	20%	Wyandotte Street East towards Banwell Road	75%
		McHugh Street towards Banwell Road	15%
		Little River Boulevard towards Banwell Road	10%
North	10%	Florence Avenue towards Riverside Drive East	0%
		Clover Avenue towards Riverside Drive East	100%
		Elinor Street towards Riverside Drive East	0%
South	10%	Clover Avenue towards Tecumseh Road East	100%
TOTAL	100%	-	-

4.6 Summary

4.6.1 Trip Generation

Table 18 provides a summary of the number of vehicle trips that Phases 3, 5, 6 and 7 of the proposed residential subdivision are anticipated to generate.

Table 18: Trip Generation Summary

	Weekday AM Peak Hour			Weekday PM Peak Hour			Saturday Mid-day Peak Hour		
	In	Out	Total	In	Out	Total	In	Out	Total
Phase 3 Trips	17	39	56	38	29	67	32	35	67
Phase 5 Trips	4	10	14	10	7	17	8	9	17
Phase 6 Trips	40	100	140	91	66	157	91	76	167
Phase 7 Trips	28	55	83	55	44	99	63	48	111
Total Vehicle Trips	89	204	293	194	145	340	194	168	362

Phases 3, 5, 6 and 7 of the proposed residential subdivision are projected to generate 293 vehicle trips during the AM peak hour, 340 vehicle trips during the PM peak hour, and 362 vehicle trips during the Saturday mid-day peak hour.

4.6.2 Site-Generated Vehicle Trips

Figure 8 illustrates how these vehicle trips were distributed and assigned by these phases through the study area intersections.

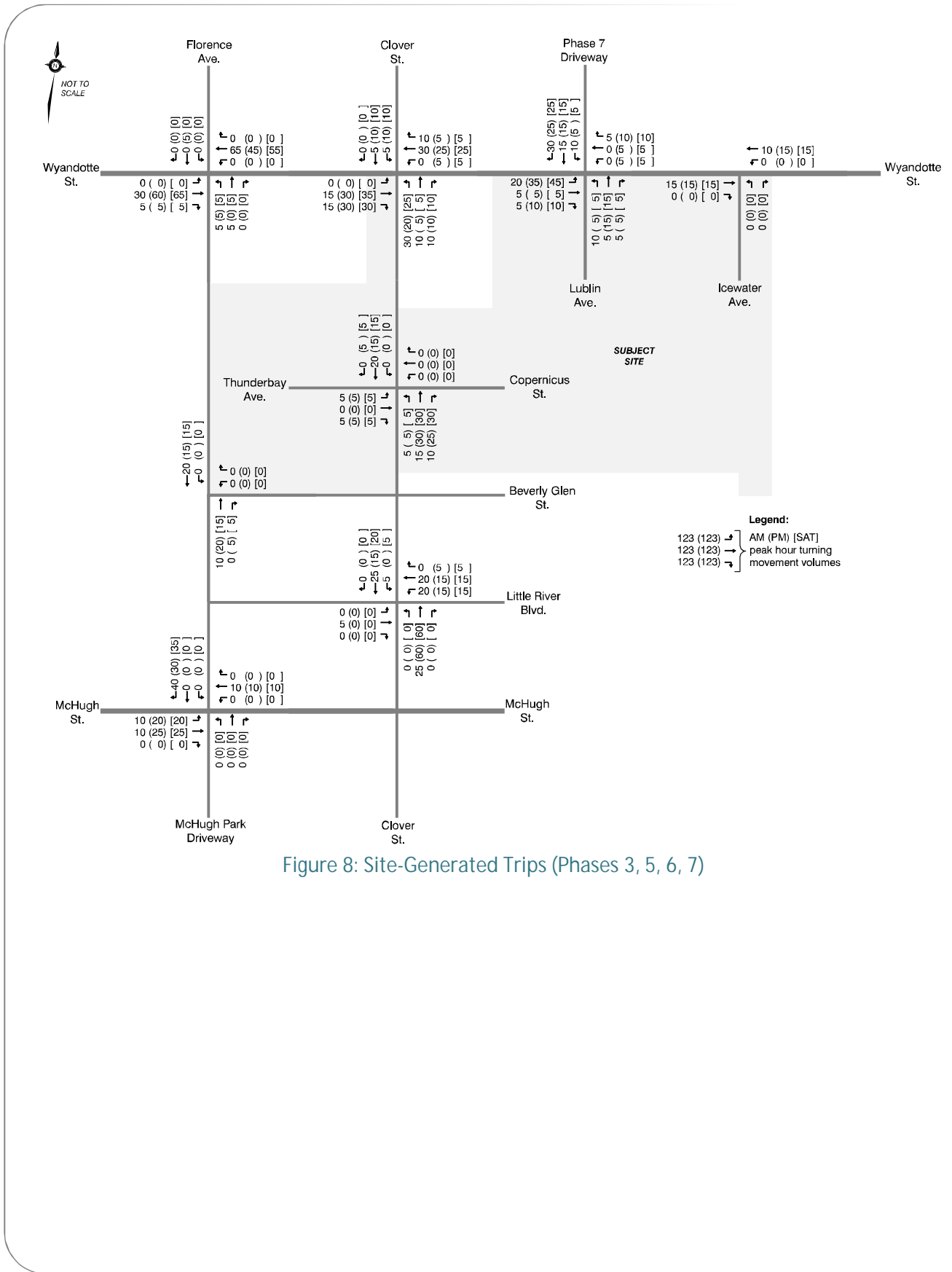

Figure 8: Site-Generated Trips (Phases 3, 5, 6, 7)

Non-Auto Travel

Three sources were reviewed in order to estimate existing modal splits in the Windsor area:

- The EWRTMP included a travel survey that recorded respondents' mode of travel for trips made during the PM peak period;
- The 2016 Census included questions about the typical mode of travel for the trip to work. This data was available both for the Windsor metropolitan area and for individual census dissemination areas;
- The 2019 Active Transportation Master Plan which notes target mode shares for 2041 for various areas within the city of Windsor:
 - For newer communities, the targeted non-auto mode share in 2041 has been identified as 14%.

Given the location and land use of the proposed subdivision, the non-auto mode share (14%) was broken down as follows:

- 5% for transit;
- 5% for walking; and
- 4% for cycling.

Table 19 summarizes the assumed modal split for the subject site development, noting that the modal split for vehicles is in line with the 2041 target mode shares as found in the City of Windsor's 2019 Active Transportation Master Plan.

Table 19: Projected Site Development Modal Split

Mode	Weekday AM peak hour	Weekday PM peak hour trips	Saturday Mid-day peak hour trips	Modal Split
Auto ²	293	340	362	86%
Transit	17	20	21	5%
Walking	17	20	21	5%
Cycling	14	15	17	4%
Total	341	395	421	100%

When considering both auto and non-auto modes, the proposed residential subdivision is projected to generate 341 total trips during the AM peak hour, 395 total trips during the PM peak hour and 421 total trips during the Saturday mid-day peak hour.

² The number of vehicles being generated by the site as noted in Section 4.6.1.

5.0 Total Future Conditions

5.1 Redistribution and Reassignment

As the subject subdivision is anticipated to introduce four new north-south streets to the immediate south of Wyandotte Street East, it is anticipated that some of the existing and future background traffic volumes both inside and outside of the study area will ultimately travel via these new streets.

5.1.1 Clover Avenue and Florence Avenue Extensions

With the completion of Phase 3 of the subject residential subdivision, both Florence Avenue and Clover Avenue are anticipated to be continuous between Riverside Drive East to the north and McHugh Street to the south.

Currently to the west of the subdivision lands, Lauzon Road/Lauzon Parkway is the nearest corridor that is present that fully extends between Wyandotte Street East and Tecumseh Road East. Similarly, Banwell Avenue is the nearest corridor that currently exists to the east of the subdivision and connects between Wyandotte Street East and Tecumseh Road East.

Given these new road connections, it is anticipated some induced traffic will ultimately travel along the Florence Avenue and Clover Avenue corridors. Due to Clover Avenue travelling in a direct north-south alignment (featuring no horizontal curves), and as it will ultimately be continuous from Riverside Drive East south to Tecumseh Road East, it is anticipated that Clover Avenue will carry more induced traffic compared to the Florence Avenue corridor, which travels in a less direct alignment and only extends south to McHugh Street.

5.1.1.1 Background Development Trips

With the Clover Avenue extension built by 2027, the traffic associated with a number of background developments were ultimately reassigned to the Clover Avenue corridor from Lublin Avenue. The vehicle trips generated by Phases 1 and 4 of the subject development that were travelling to/from the north and east were reassigned to utilize Clover Avenue rather than Lublin Avenue extension. The trips generated by these background developments were not assigned to the Florence Avenue extension as Clover Avenue is notably closer to these phases of the subdivision compared to Clover Avenue.

5.1.1.2 Induced Vehicle Trips

In order to estimate the potential induced traffic volumes along the Florence Avenue and Clover Avenue corridors, data from several peak hour turning movement counts outside the study area were obtained from the City of Windsor. The data included turning movement counts for three intersections, noting no turning movement data was available on Saturday:

- Greenpark Boulevard and Riverside Drive East (unsignalized);
- Banwell Road and Wyandotte Street East (unsignalized); and
- Banwell Road and McHugh Street (signalized).

It should be noted that each of these three intersections are found to the east of the proposed subdivision. This is largely due to the layout of the road network outside of the study area and considering the current alignment of the Lauzon Road corridor and the future alignments and locations of both the Florence Avenue and Clover Avenue corridors. As a result, it is not anticipated that a notable number of vehicles will be shifted from the Lauzon Road corridor compared to the Banwell Road corridor. Given this, it was assumed that majority of the vehicle trips using the Florence Avenue and/or Clover Avenue extensions would travel to/from the south and east. It was also assumed that the existing and future trips to the west of the study area are largely expected to remain on the Lauzon Road/Lauzon Parkway corridors given the distance between the subdivision and the alignments of these corridors. In addition, limited trips were assumed to be redistributed and reassigned to/from the north due to the presence of the Detroit River.

In order to consider the percentage and number of vehicles that may be redistributed and reassigned to the Clover Avenue and Florence Avenue corridors, several movements at the Wyandotte Street East and Banwell Road intersection were reviewed. This considered the volumes for the eastbound right-turn and northbound left-turn to determine the potential number of vehicles that may be shifted from the Banwell Road corridor to the Clover Avenue and Florence Avenue corridors.

Within the subsequent analyses, it was ultimately assumed that 50% of these turning volumes at the Wyandotte Street and Banwell Road intersection would be shifted to the Florence Avenue or Clover Avenue extensions. It was also assumed that the Florence Avenue extension would carry 25% of the reassigned trips, while Clover Avenue would carry the remaining 75% trips. Clover Avenue is likely to attract more traffic due to its overall connectivity in the road network (i.e., it is continuous from Riverside Drive East south to Tecumseh Road East) compared to Florence Avenue. Additionally, Florence Avenue has a less direct alignment (with some horizontal curvature) compared to Clover Avenue (which is straight), likely making it less attractive from a driver choice standpoint.

To determine the induced Saturday peak hour traffic volumes along the future Florence Avenue and Clover Avenue corridors, the existing turning movement counts and the 2032 total future traffic volumes at the two intersections along Wyandotte Street East at Clover Avenue and Florence Avenue were reviewed. These traffic volumes during the PM peak hour and the Saturday mid-day peak hour were compared to determine a factor to estimate the Saturday volumes. As a result, it was found that the Saturday mid-day peak hour traffic volumes within the study area are approximately 80% of the PM peak hour traffic volumes.

Table 20 summarizes the number of induced vehicles that were assumed to travel along the Florence Avenue or Clover Avenue extensions.

Table 20: Induced Traffic Volumes along Florence Avenue and Clover Avenue

	AM Peak Hour			PM Peak Hour			Saturday Peak Hour		
	NB	SB	Total	NB	SB	Total	NB	SB	Total
Florence Avenue	35	20	55	25	50	75	20	40	60
Clover Avenue	105	60	165	80	145	225	65	120	185

Figure 9 shows how these induced vehicle trips were applied to the various movements within the study area.

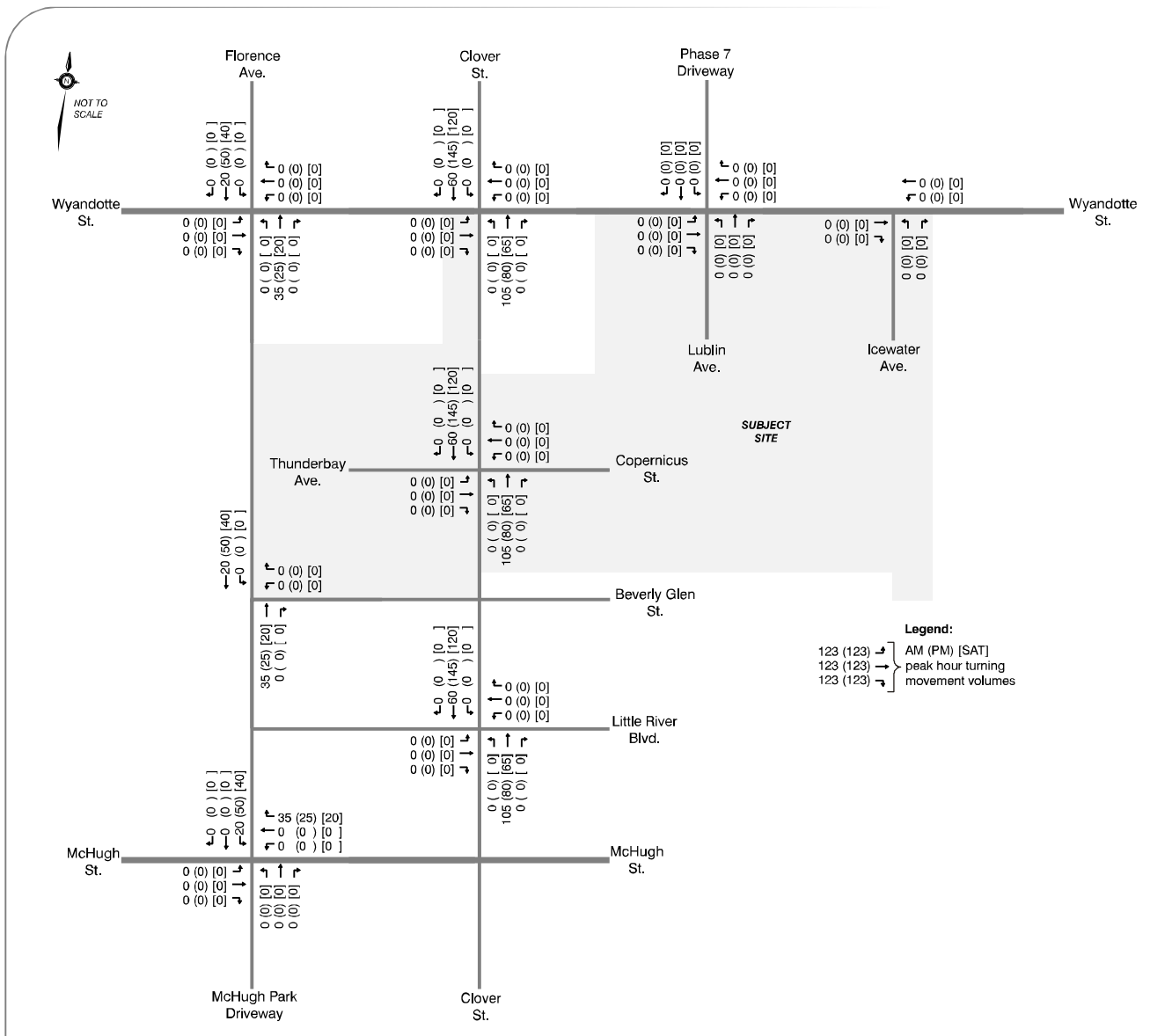

Figure 9: Additional Induced Traffic Volumes on Clover Avenue and Florence Avenue

5.2

Total Future Traffic Volumes

The total future traffic volumes were calculated by adding the site-generated trips as distributed and assigned to the future background traffic volumes as well as adding in the reassigned and induced traffic volumes along the Florence Avenue and Clover Avenue corridors.

Within the subject subdivision, two additional intersections were also assessed. These intersections were:

- Florence Avenue and Beverly Glen Street; and
- Clover Avenue and Copernicus Street.

Both of these intersections were assumed to operate under two-way stop control (TWSC), where the traffic on the main street would have the right-of-way. At the Florence Avenue and Beverly Glen Street intersection, Florence Avenue is anticipated to have the right-of-way, while Beverly Glen Street would be STOP-controlled. At the Clover Avenue and Copernicus Street intersection, Clover Avenue is anticipated to have the right-of-way, while Copernicus Street would be STOP-controlled.

5.2.1 Total Future (2027) Traffic Volumes

Figure 10 illustrates the total future (2027) traffic volumes, noting that all volumes were rounded to the nearest five vehicles.

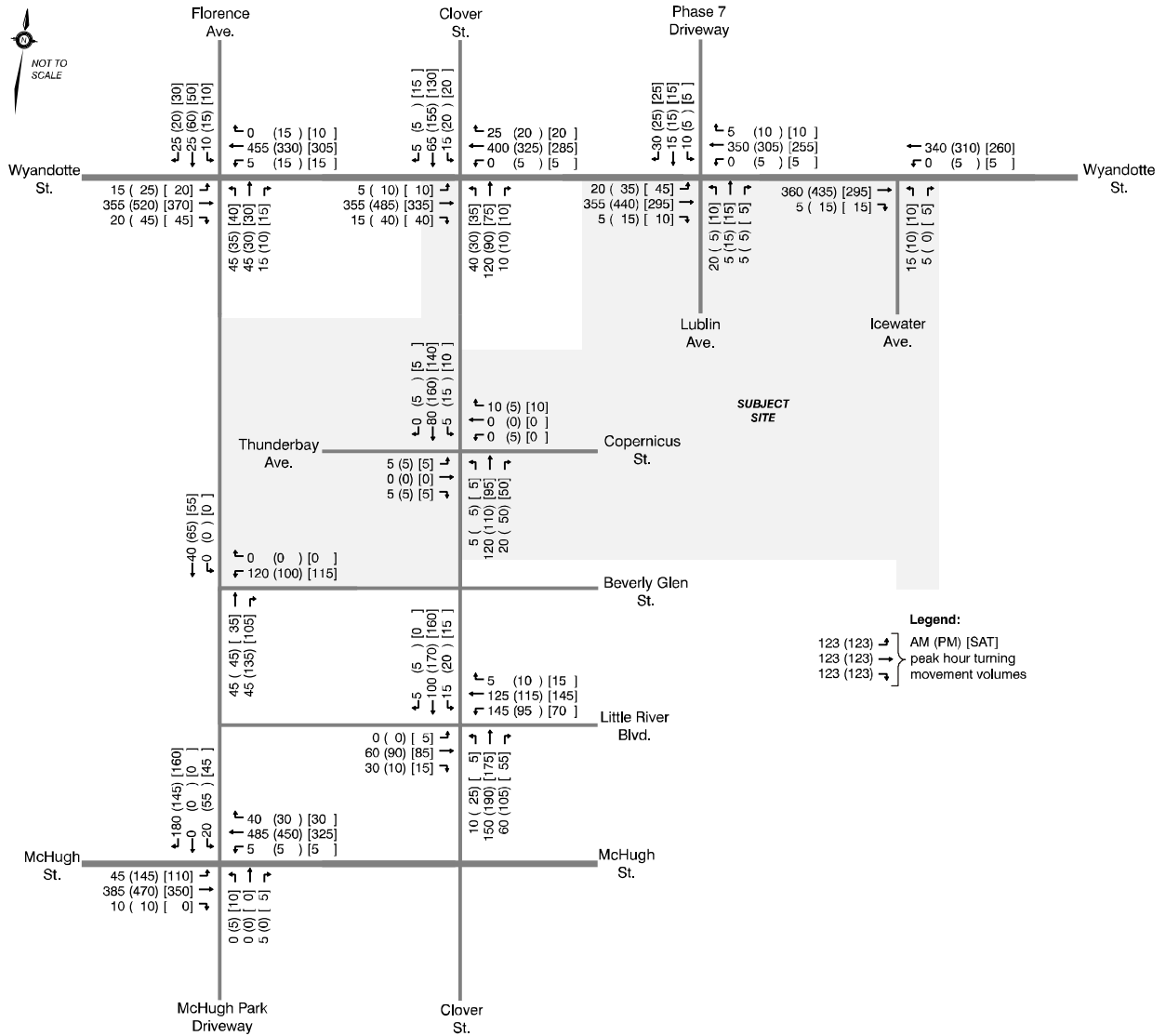
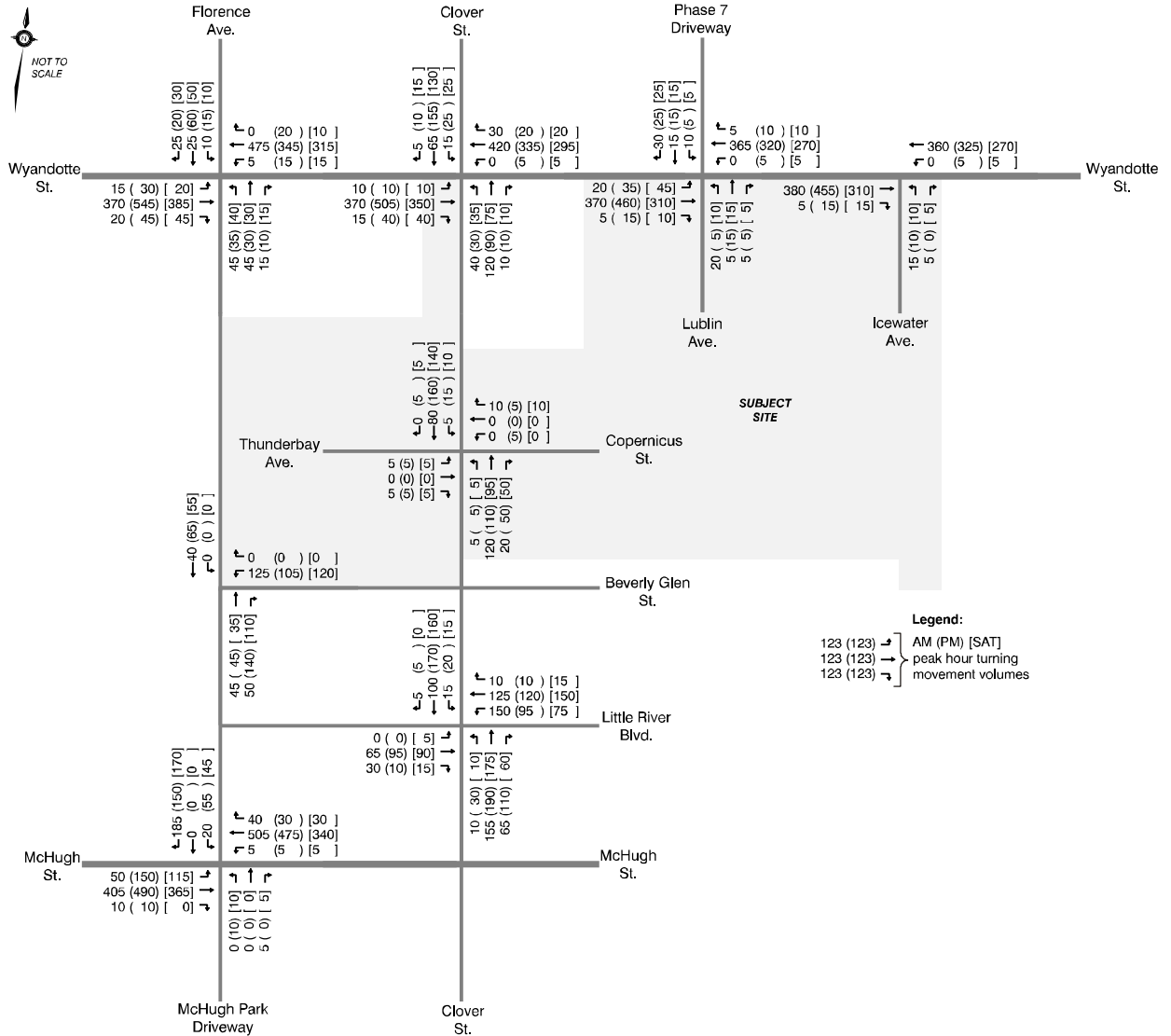

Figure 10: Total Future (2027) Traffic Volumes

5.2.2 Total Future (2032) Traffic Volumes

Figure 11 illustrates the total future (2032) traffic volumes, noting that all volumes were rounded to the nearest five vehicles.



5.3 Total Future Operational Analyses

5.3.1 Total Future (2027) Intersection Operations

Table 21 summarizes the intersection operations under the total future (2027) peak hour traffic volumes. Within the total future analysis, it has been assumed that both eastbound and westbound left-turn lanes have been introduced at the Clover Avenue and Wyandotte Street East intersection.

Table 21: Total Future (2027) Intersection Operations

Intersection	Movement	Weekday AM Peak Hour				Weekday PM Peak Hour				Saturday Mid-day Peak Hour			
		v/c	LOS	Delay (s/veh)	95th %ile queue (m)	v/c	LOS	Delay (s/veh)	95th %ile queue (m)	v/c	LOS	Delay (s/veh)	95th %ile queue (m)
Wyandotte Street East and Florence Avenue	EBL	0.01	A	8.4	0	0.02	A	8.1	1	0.02	A	8.0	0
	WBL	0.00	A	8.1	0	0.02	A	8.8	0	0.01	A	8.3	0
	NBLTR	0.46	D	31.1	18	0.45	E	39.6	17	0.35	D	25.6	12
	SBLTR	0.21	C	19.6	6	0.43	D	30.8	16	0.28	C	19.5	9
Wyandotte Street East and Clover Avenue	EBL	0.00	A	8.3	0	0.01	A	8.1	0	0.01	A	8.0	0
	WBL	0.00	A	0.0	0	0.00	A	8.6	0	0.00	A	8.1	0
	NBLTR	0.67	E	40.5	35	0.75	F	64.8	39	0.46	D	27.9	18
	SBLTR	0.35	D	26.0	12	0.82	F	64.5	50	0.54	D	27.5	24
McHugh Street and Florence Avenue	SBLR	0.37	B	14.6	14	0.61	D	30.0	31	0.41	C	16.3	16
Little River Boulevard and Clover Avenue	NBLTR	0.51	C	20.3	23	0.65	C	23.3	37	0.47	C	17.3	20
	SBLTR	0.36	C	20.2	13	0.50	C	21.9	22	0.42	C	18.5	16
Wyandotte Street East and Lublin Avenue	NBLTR	0.11	C	19.2	3	0.09	C	19.1	2	0.09	C	16.4	2
	SBLTR	0.14	B	14.8	4	0.12	C	15.3	3	0.10	B	13.2	3
Wyandotte Street East and Icewater Avenue	NBLR	0.05	B	14.1	1	0.03	C	16.0	1	0.03	B	12.3	1

Intersection	Movement	Weekday AM Peak Hour				Weekday PM Peak Hour				Saturday Mid-day Peak Hour			
		v/c	LOS	Delay (s/veh)	95th %ile queue (m)	v/c	LOS	Delay (s/veh)	95th %ile queue (m)	v/c	LOS	Delay (s/veh)	95th %ile queue (m)
Clover Avenue and Copernicus Street	EBLTR	0.01	A	9.5	0	0.01	B	10.3	0	0.01	B	10.0	0
	WBLTR	0.01	A	9.0	0	0.01	B	10.2	0	0.01	A	9.0	0
Florence Avenue and Beverly Glen Street	WBLR	0.15	A	9.8	4	0.14	B	10.2	4	0.15	B	10.1	4

Compared to future background (2027) operations, most movements at the four existing and four future study area intersections are projected to continue operating in an acceptable manner (LOS D or better). However, several movements at the Wyandotte Street East and Clover Avenue intersection are now are anticipated to operate at LOS E or LOS F during the AM and PM peak hours. Minimal delay and queuing is projected for all other movements.

At the Wyandotte Street East and Clover Avenue intersection, the northbound approach during the AM and PM peak hours, and the southbound approach during the PM peak hour, are projected to operate at LOS E or LOS F. During the PM peak hour, the northbound 95th percentile queue is expected to extend 39 metres south of the intersection, while the southbound 95th percentile queue is expected to extend 50 metres north of the intersection.

At the Wyandotte Street East and Florence Avenue intersection, the northbound approach during the PM peak hour is projected to operate at LOS E with a 95th percentile queue of 17 metres.

As mentioned in Section 5.1.1, induced volumes were reassigned along Clover Avenue and Florence Avenue. The poor operations at the two Wyandotte Street East intersections are largely due to the amount of induced traffic that has been added to the Clover Avenue and Florence Avenue corridors. This is discussed further in Section 5.3.2.1.

5.3.2

Total Future (2032) Intersection Operations

Table 22 summarizes the intersection operations under the total future (2032) peak hour traffic volumes.

Table 22: Total Future (2032) Intersection Operations

Intersection	Movement	Weekday AM Peak Hour				Weekday PM Peak Hour				Saturday Mid-day Peak Hour			
		v/c	LOS	Delay (s/veh)	95th %ile queue (m)	v/c	LOS	Delay (s/veh)	95th %ile queue (m)	v/c	LOS	Delay (s/veh)	95th %ile queue (m)
Wyandotte Street East and Florence Avenue	EBL	0.02	A	8.5	0	0.03	A	8.2	1	0.02	A	8.0	0
	WBL	0.00	A	8.2	0	0.02	A	8.9	0	0.01	A	8.3	0
	NBLTR	0.48	D	33.9	20	0.50	E	46.6	19	0.36	D	26.9	13
	SBLTR	0.22	C	20.6	7	0.47	D	35.0	18	0.29	C	20.1	10
Wyandotte Street East and Clover Avenue	EBL	0.01	A	8.4	0	0.01	A	8.1	0	0.01	A	8.0	0
	WBL	0.00	A	0.0	0	0.01	A	8.7	0	0.00	A	8.2	0
	NBLTR	0.72	E	49.2	40	0.81	F	79.9	44	0.48	D	29.9	20
	SBLTR	0.39	D	29.3	14	0.90	F	82.3	60	0.58	D	30.6	27
McHugh Street and Florence Avenue	SBLR	0.39	C	15.2	15	0.66	D	34.4	36	0.44	C	17.1	18
Little River Boulevard and Clover Avenue	NBLTR	0.54	C	21.7	26	0.68	D	25.4	42	0.51	C	18.8	23
	SBLTR	0.37	C	21.2	13	0.51	C	22.5	23	0.44	C	19.5	17
Wyandotte Street East and Lublin Avenue	NBLTR	0.12	C	20.0	3	0.10	C	20.0	3	0.10	C	17.0	3
	SBLTR	0.15	C	15.3	4	0.13	C	15.9	3	0.10	B	13.6	3
Wyandotte Street East and Icewater Avenue	NBLR	0.05	B	14.7	1	0.03	C	16.6	1	0.03	B	12.6	1
Clover Avenue and Copernicus Street	EBLTR	0.01	A	9.5	0	0.01	B	10.3	0	0.01	B	10.0	0
	WBLTR	0.01	A	9.0	0	0.01	B	10.2	0	0.01	A	9.0	0
Florence Avenue and Beverly Glen Street	WBLR	0.16	A	9.9	4	0.14	B	10.3	4	0.16	B	10.1	4

Compared to the future background (2032) operations, most movements at the four existing and future study area intersections are projected to continue operating in an acceptable manner. However, several movements at the Wyandotte Street East and Clover Avenue intersection and the Wyandotte Street East and Florence Avenue intersection are anticipated to operate at LOS E or LOS F during the AM and PM peak hours. Minimal delay and queuing is projected for all other movements.

Compared to the total future (2027) operations, the same critical moments at the Wyandotte Street East and Clover Avenue intersection are projected to continue operating at LOS E during the AM peak hour and LOS F during the PM peak hour. During the PM peak hour, the 95th percentile queues at the Wyandotte Street East and Clover Avenue intersection are expected to increase by 10 metres.

5.3.2.1

Removal of the Induced Traffic Volumes

Table 23 summarizes the projected operations at the two Wyandotte Street intersections should the induced volumes be removed from the total future (2032) peak hour traffic volumes. In all cases, the STOP-controlled approaches would include a single lane only.

Table 23: Total Future (2032) Intersection Operations With Removal of the Induced Volumes

Intersection	Movement	Weekday AM Peak Hour				Weekday PM Peak Hour				Saturday Mid-day Peak Hour			
		v/c	LOS	Delay (s/veh)	95th %ile queue (m)	v/c	LOS	Delay (s/veh)	95th %ile queue (m)	v/c	LOS	Delay (s/veh)	95th %ile queue (m)
Wyandotte Street East and Florence Avenue	NBLTR	0.31	D	26.0	10	0.28	D	30.5	9	0.25	C	22.0	8
	SBLTR	0.12	C	16.5	3	0.18	C	21.0	5	0.13	B	14.9	4
Wyandotte Street East and Clover Avenue	NBLTR	0.25	C	21.8	8	0.22	C	23.5	7	0.18	C	18.1	5
	SBLTR	0.09	C	19.5	3	0.19	C	21.9	5	0.15	C	16.3	4

Should the induced volumes not be included in the total future (2032) traffic volumes, these STOP-controlled approaches would instead be projected to operate at LOS D or better during the AM and PM peak hours.

5.4

Potential Traffic Control along Wyandotte Street

Given it is not possible to fully know the actual number and nature of the induced traffic volumes that will ultimately travel along the Clover Avenue and Florence Avenue corridors, it is best for these future intersections along Wyandotte Street East to be monitored to see if any changes to traffic control are warranted in the future based on actual traffic volumes that would be collected in the field. Given the induced traffic volumes along the Clover Avenue and Florence Avenue corridors are very high-level projections, no mitigation analysis was completed, especially since all STOP-controlled movements are

expected to operate at LOS D or better without the induced traffic included in the total future (2032) traffic volumes.

Without the induced traffic volumes, a STOP-controlled approach at Clover Avenue and Florence Avenue is appropriate. However, dependant on the level of induced traffic added to these two corridors, traffic signals may need to be introduced at one or both intersections along Wyandotte Street East.

5.5

Potential Laning along Clover Avenue and Florence Avenue

When considering the total future (2032) traffic volumes (which include the induced traffic volumes) at the Wyandotte Street East and Florence Avenue intersection the northbound single-lane STOP-controlled approach is projected to operate at LOS E or better and the southbound single-lane STOP-controlled approach is anticipated to operate at LOS D or better during the AM, PM and Saturday peak hours.

At the Wyandotte Street East and Clover Avenue intersection, the single-lane northbound and southbound STOP-controlled approaches are projected to operate at LOS F or better.

In order to improve operations at both of these intersections, exclusive left-turn lanes were considered along both Florence Avenue and Clover Avenue on the STOP-controlled approaches. As a result, there would be two approach lanes on the north and south legs of the intersection, where a left-turn lane and a shared through/right-turn lane would be provided.

Table 24 summarizes the projected operations under the total future (2032) traffic volumes at the two Wyandotte Street East intersections when the northbound and southbound left-turn lanes are added.

Table 24: Total Future (2032) Intersection Operations With Added Left-Turn Lanes

Intersection	Movement	Weekday AM Peak Hour				Weekday PM Peak Hour				Saturday Mid-day Peak Hour			
		v/c	LOS	Delay (s/veh)	95th %ile queue (m)	v/c	LOS	Delay (s/veh)	95th %ile queue (m)	v/c	LOS	Delay (s/veh)	95th %ile queue (m)
Wyandotte Street East and Florence Avenue	NBL	0.26	D	30.9	8	0.31	E	46.9	10	0.22	D	28.2	6
	NBTR	0.22	C	20.8	7	0.19	C	23.9	5	0.14	C	17.4	4
	SBL	0.06	D	26.2	2	0.10	D	30.8	3	0.05	C	21.2	1
	SBTR	0.16	C	17.6	5	0.37	D	28.5	13	0.25	C	18.4	8
Wyandotte Street East and Clover Avenue	NBL	0.22	D	28.7	7	0.39	F	72.1	12	0.21	D	30.2	6
	NBTR	0.50	D	30.2	21	0.42	D	28.9	16	0.27	C	19.3	9
	SBL	0.11	D	34.1	3	0.19	E	35.7	5	0.11	C	22.0	3
	SBTR	0.27	C	22.5	9	0.72	E	49.0	39	0.46	C	24.5	19

With the added left-turn lanes, operations on the STOP-controlled approaches are projected to slightly improve.

At the Wyandotte Street East and Florence Avenue intersection, the northbound left-turn movement is projected to operate at LOS E or better, the northbound shared through-right is projected to operate at LOS C, the southbound left-turn movement would operate at LOS D or better, and the southbound shared through-right would operate at LOS D or better. However, all STOP-controlled movements at this intersection are projected to operate with a v/c ratio of 0.37 or better, meaning all STOP-controlled movements would operate well beneath capacity. The 95th percentile queue length would be 13 metres, or approximately two vehicles long.

At the Wyandotte Street East and Clover Avenue intersection, the northbound left would operate at LOS F or better, the northbound shared through-right would operate at LOS D, the southbound left would operate at LOS E or better, and the southbound shared through-right would operate at LOS E or better. However, all STOP-controlled movements at this intersection are projected to operate with a v/c ratio of 0.72 or better, meaning all STOP-controlled movements would operate below capacity. The 95th percentile queue length would be 39 metres, or approximately five vehicles long.

In summary, the two intersections are projected to have movements that continue operating at LOS E or LOS F. However, the v/c ratios, delays and the 95th percentiles queues are expected to decrease noticeably should left-turn lanes be introduced.

To decrease v/c ratios, delays, and 95th percentile queues at the STOP-controlled approaches under total future (2032) conditions, it is recommended that northbound and southbound left-turn lanes be added to these two intersections along Wyandotte Street East. On Florence Avenue, both the northbound and southbound left-turn lanes should feature 25 metres of storage. On Clover Avenue, the northbound approach should feature a left-turn lane with 25 metres of storage. However, the southbound left-turn lane should feature 40 metres of storage.

6.0 Internal Traffic Control

The minor streets and driveways within the development, and roads that connect to Wyandotte Street East, require STOP-control. When reviewing the existing traffic control at certain intersections surrounding the proposed subdivision, Clover Avenue has been found to typically not have STOP control along the street (other than at Wyandotte Street East and at Little River Boulevard) while all intersecting streets to Clover Avenue feature STOP control.

Figure 12 displays the recommended internal traffic control within the site.

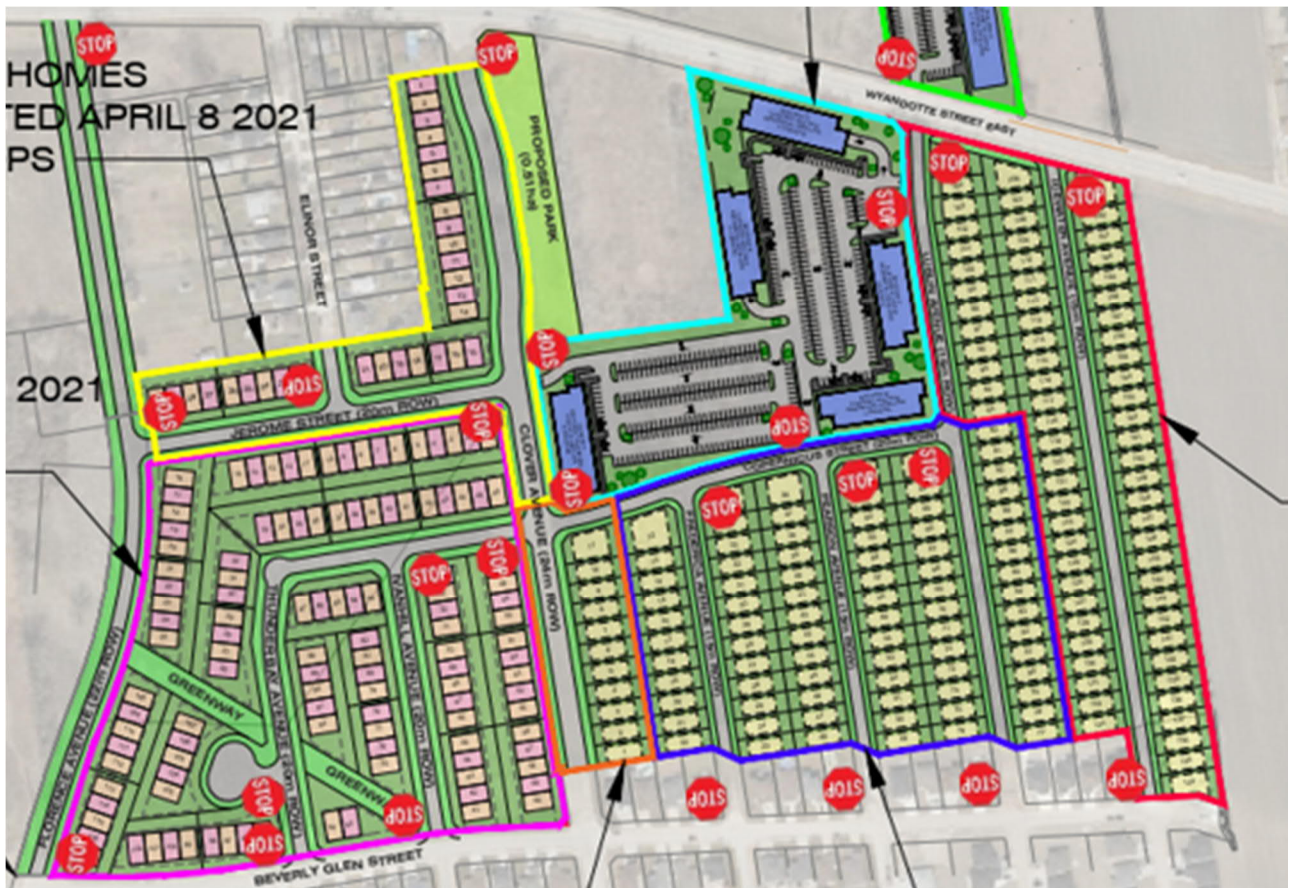

Figure 12: Recommended Internal Traffic Control

Summary

Dillon Consulting Limited (Dillon) has been retained by 1027458 Ontario Inc., to undertake a comprehensive transportation impact study (TIS) which reviews several phases as noted within the proposed 'North Neighbourhood Subdivision' located in the city of Windsor, Ontario. This residential subdivision is found in lands within the East Riverside Secondary Plan area. It should be noted that Phases 1, 2, and 4 have already been approved while the remaining phases (Phases 3, 5, 6, and 7) are now moving forward for approval with each phase including the following:

- Phase 3, which includes 117 townhome dwelling units and would be located on the northeast corner of the Florence Avenue and Beverly Glen Street intersection;
- Phase 5, which includes 30 townhome dwelling units and would be located to the immediate north of Phase 3;
- Phase 6, which includes 447 apartment dwelling units in five (5) apartment buildings found on the southwest quadrant of the Wyandotte Street East and Lublin Avenue intersection; and
- Phase 7, which includes 308 apartment dwelling units in two (2) apartment buildings and is located to the immediate north of the future Wyandotte Street East and Lublin Avenue intersection.

These four phases of the proposed residential subdivision are projected to generate 239 vehicle trips during the AM peak hour, 340 vehicle trips during the PM peak hour, and 262 vehicle trips during the Saturday mid-day peak hour. A relatively small number of trips generated by these phases of the subdivision are also projected to be in the form of walking, cycling or transit trips.

As part of the proposed residential subdivision, several new north-south roadways are anticipated to be connected between Wyandotte Street East and McHugh Avenue. These include: Florence Avenue, Clover Avenue, Lublin Avenue and Icewater Avenue. As a result, it is anticipated that some trips that are currently traveling outside of the study area may ultimately travel through the subdivision, noting most of this traffic would be anticipated to travel along the Clover Avenue corridor given its direct alignment and as it will ultimately connect from Riverside Drive East south to Tecumseh Road East.

In order to calculate the potential induced traffic volumes, it was ultimately assumed that 50% of the turning volumes at the Wyandotte Street and Banwell Road intersection would be shifted to the future Florence Avenue or Clover Avenue extensions. It was also assumed that the Florence Avenue extension would carry 25% of the reassigned induced trips, while Clover Avenue would carry the remaining 75% trips. This is based on the Clover Avenue corridor being more attractive to motorists due to its direct north-south alignment and continuity between Riverside Drive East and Tecumseh Road East.

Most movements at the four existing and four future study area intersections are projected to operate in an acceptable manner through to the 2032 horizon year with the subject subdivision in place. However, several movements at the Wyandotte Street East and Clover Avenue intersection and the

Wyandotte Street East and Florence Avenue intersection are anticipated to operate at LOS E or LOS F during the AM and PM peak hours beginning in 2027. Minimal delay and queuing is projected for all other movements. Should the induced volumes not be added to the total future (2032) traffic volumes, the northbound and southbound approaches can be expected to operate at LOS D or better during the PM peak hour.

Given that the induced traffic volumes along the Clover Avenue and Florence Avenue corridors are very high-level projections, no mitigation for traffic control (i.e., a traffic signal) was completed at the Clover Avenue and Wyandotte Street East intersection or the Florence Avenue and Wyandotte Street East intersection. Nonetheless, based on the geometry and laning that is ultimately anticipated along Wyandotte Street East, a traffic signal would be anticipated to be the form of traffic control that may need to be introduced in the future. Therefore, it is recommended that these intersections be monitored, with new turning movement counts and traffic signal warrants undertaken following the completion of the various background developments, the subject subdivision and the internal road network.

In order to decrease the projected v/c ratios, delays, and 95th percentile queues at the STOP-controlled approaches along both Clover Avenue and Florence Avenue under the total future (2032) traffic volumes, it is recommended that northbound and southbound left-turn lanes be added to these two intersections along Wyandotte Street East. On Florence Avenue, both these left-turn lanes should feature 25 metres of storage. On Clover Avenue, the northbound approach should feature a left-turn lane with 25 metres of storage. However, the southbound left-turn lane should feature 40 metres of storage.



Appendix A

Conceptual Development Plan



PHASE 5: 30 TOWNHOMES
 - PRE CON SUBMITTED APRIL 8 2021
 - PREPARING ZBA/DPS

PHASE 6: 447 UNITS
 - PRE CON - ZBA/DPC

PHASE 7: 308 UNITS
 - PRE CON - ZBA/DPC

PHASE 3: 117 TOWNHOMES
 - PRE CON COMPLETED DEC 9 2021
 - PIC COMPLETED FEB 22 2021
 - PREPARING OPA/ZBA/DPS













PHASE 2: 82 LOTS
 - DRAFT APPROVED

FLORENCE AVENUE EXTENSION
 DEDICATED TO THE CITY OF WINDSOR

PHASE 4: 11 LOTS
 - DRAFT APPROVED

PHASE 1: 81 LOTS
 - DRAFT APPROVED

1027458 ONTARIO INC.
 EAST RIVERSIDE DEVELOPMENT
 NORTH NEIGHBOURHOOD
 PHASES 1 -7 (incl.)

 SUBJECT AREA PHASE 1 (± 4.51ha)	 SUBJECT AREA PHASE 2 (± 3.90ha)	 SUBJECT AREA PHASE 3 (± 6.22ha)	 SUBJECT AREA PHASE 4 (± 0.93ha)	 SUBJECT AREA PHASE 5 (± 2.30ha)	 SUBJECT AREA PHASE 6 (± 3.48ha)	 SUBJECT AREA PHASE 7 (± 1.65ha)
 PROPOSED TOWNHOMES	 PROPOSED SINGLE DETACHED DWELLINGS	 MULTI-UNIT RESIDENTIAL BUILDINGS	 PROPOSED ROW	 PROPOSED PARK LANDS		

**CONCEPTUAL DEVELOPMENT PLAN
 MASTER PHASING PLAN**

File Location:
 c:\pw working directory\projects 2021\dillon_32mru\d0101615\21-1185 - master
 plan.dwg
 August, 22, 2022 11:57 AM

MAP/DRAWING INFORMATION
 THIS DRAWING IS FOR INFORMATION PURPOSES ONLY. ALL
 DIMENSIONS AND BOUNDARY INFORMATION SHOULD BE
 VERIFIED BY AN O.L.S PRIOR TO CONSTRUCTION.
 CREATED BY: MRU
 CHECKED BY: KDT
 DESIGNED BY: MRU

SCALE: N.T.S.



SOURCE: MAPPMYCITY WINDSOR AERIAL (2021)

PROJECT: 21-1185/1186
 STATUS: DRAFT
 DATE: 07/07/2022

Appendix B

Traffic Volume Data

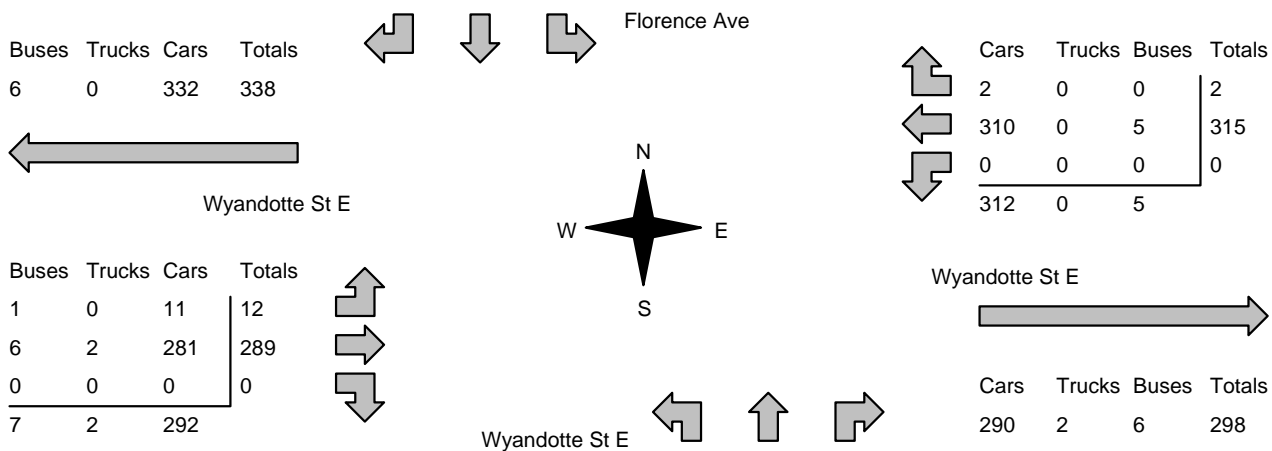
Morning Peak Diagram		Specified Period From: 7:00:00 To: 10:00:00	One Hour Peak From: 7:45:00 To: 8:45:00																												
Municipality: Windsor Site #: 2202100001 Intersection: Wyandotte St E & Florence Ave TFR File #: 1 Count date: 16-Feb-22		Weather conditions: Person counted: Person prepared: Person checked:																													
** Non-Signalized Intersection **		Major Road: Wyandotte St E runs W/E																													
North Leg Total: 46 North Entering: 32 North Peds: 2 Peds Cross: ☒	<table style="border-collapse: collapse;"> <tr><td>Buses</td><td>1</td><td>0</td><td>0</td><td style="border-left: 1px solid black;">1</td></tr> <tr><td>Trucks</td><td>0</td><td>0</td><td>0</td><td style="border-left: 1px solid black;">0</td></tr> <tr><td>Cars</td><td>22</td><td>0</td><td>9</td><td style="border-left: 1px solid black;">31</td></tr> <tr><td>Totals</td><td>23</td><td>0</td><td>9</td><td style="border-left: 1px solid black;"></td></tr> </table>	Buses	1	0	0	1	Trucks	0	0	0	0	Cars	22	0	9	31	Totals	23	0	9		<table style="border-collapse: collapse;"> <tr><td>Buses</td><td>1</td></tr> <tr><td>Trucks</td><td>0</td></tr> <tr><td>Cars</td><td>13</td></tr> <tr><td>Totals</td><td>14</td></tr> </table>	Buses	1	Trucks	0	Cars	13	Totals	14	East Leg Total: 615 East Entering: 317 East Peds: 0 Peds Cross: ☒
Buses	1	0	0	1																											
Trucks	0	0	0	0																											
Cars	22	0	9	31																											
Totals	23	0	9																												
Buses	1																														
Trucks	0																														
Cars	13																														
Totals	14																														
																															
<table style="border-collapse: collapse;"> <tr><td>Buses</td><td>Trucks</td><td>Cars</td><td>Totals</td></tr> <tr><td>6</td><td>0</td><td>332</td><td>338</td></tr> </table>	Buses	Trucks	Cars	Totals	6	0	332	338		<table style="border-collapse: collapse;"> <tr><td>Cars</td><td>Trucks</td><td>Buses</td><td>Totals</td></tr> <tr><td>2</td><td>0</td><td>0</td><td>2</td></tr> <tr><td>310</td><td>0</td><td>5</td><td>315</td></tr> <tr><td>0</td><td>0</td><td>0</td><td>0</td></tr> <tr><td>312</td><td>0</td><td>5</td><td></td></tr> </table>	Cars	Trucks	Buses	Totals	2	0	0	2	310	0	5	315	0	0	0	0	312	0	5		
Buses	Trucks	Cars	Totals																												
6	0	332	338																												
Cars	Trucks	Buses	Totals																												
2	0	0	2																												
310	0	5	315																												
0	0	0	0																												
312	0	5																													
<table style="border-collapse: collapse;"> <tr><td>Buses</td><td>Trucks</td><td>Cars</td><td>Totals</td></tr> <tr><td>1</td><td>0</td><td>11</td><td>12</td></tr> <tr><td>6</td><td>2</td><td>281</td><td>289</td></tr> <tr><td>0</td><td>0</td><td>0</td><td>0</td></tr> <tr><td>7</td><td>2</td><td>292</td><td></td></tr> </table>	Buses	Trucks	Cars	Totals	1	0	11	12	6	2	281	289	0	0	0	0	7	2	292				<table style="border-collapse: collapse;"> <tr><td>Cars</td><td>Trucks</td><td>Buses</td><td>Totals</td></tr> <tr><td>290</td><td>2</td><td>6</td><td>298</td></tr> </table>	Cars	Trucks	Buses	Totals	290	2	6	298
Buses	Trucks	Cars	Totals																												
1	0	11	12																												
6	2	281	289																												
0	0	0	0																												
7	2	292																													
Cars	Trucks	Buses	Totals																												
290	2	6	298																												
Peds Cross: ☒ West Peds: 1 West Entering: 301 West Leg Total: 639	<table style="border-collapse: collapse;"> <tr><td>Cars</td><td>0</td></tr> <tr><td>Trucks</td><td>0</td></tr> <tr><td>Buses</td><td>0</td></tr> <tr><td>Totals</td><td>0</td></tr> </table>	Cars	0	Trucks	0	Buses	0	Totals	0	<table style="border-collapse: collapse;"> <tr><td>Cars</td><td>0</td><td>0</td><td>0</td><td style="border-left: 1px solid black;">0</td></tr> <tr><td>Trucks</td><td>0</td><td>0</td><td>0</td><td style="border-left: 1px solid black;">0</td></tr> <tr><td>Buses</td><td>0</td><td>0</td><td>0</td><td style="border-left: 1px solid black;">0</td></tr> <tr><td>Totals</td><td>0</td><td>0</td><td>0</td><td style="border-left: 1px solid black;"></td></tr> </table>	Cars	0	0	0	0	Trucks	0	0	0	0	Buses	0	0	0	0	Totals	0	0	0		Peds Cross: ☒ South Peds: 0 South Entering: 0 South Leg Total: 0
Cars	0																														
Trucks	0																														
Buses	0																														
Totals	0																														
Cars	0	0	0	0																											
Trucks	0	0	0	0																											
Buses	0	0	0	0																											
Totals	0	0	0																												
Comments																															

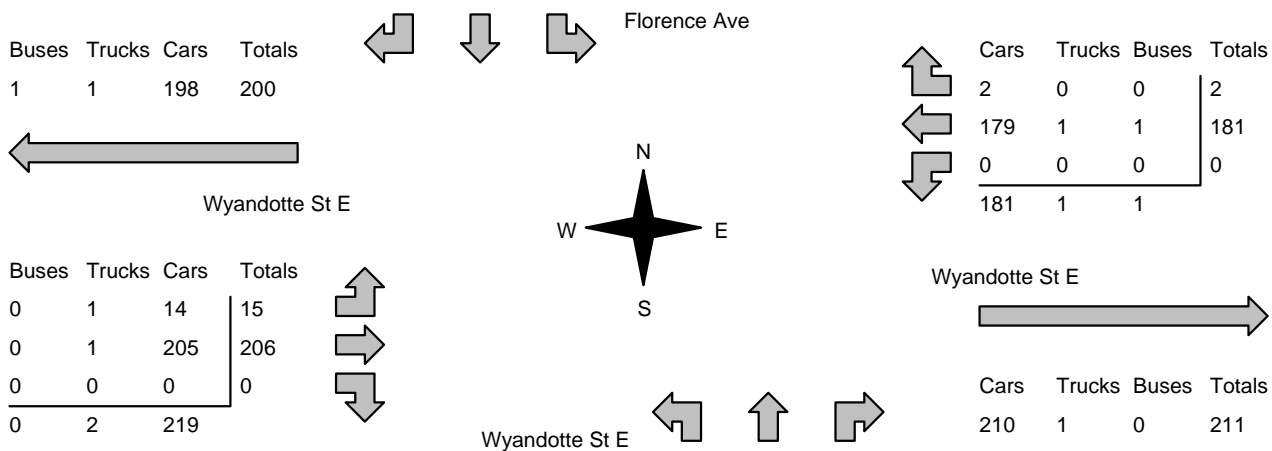
Mid-day Peak Diagram		Specified Period From: 11:00:00 To: 13:00:00	One Hour Peak From: 12:00:00 To: 13:00:00																												
Municipality: Windsor Site #: 2202100001 Intersection: Wyandotte St E & Florence Ave TFR File #: 1 Count date: 16-Feb-22		Weather conditions: Person counted: Person prepared: Person checked:																													
** Non-Signalized Intersection **		Major Road: Wyandotte St E runs W/E																													
North Leg Total: 41 North Entering: 24 North Peds: 0 Peds Cross: ☒	<table style="border-collapse: collapse;"> <tr><td>Buses</td><td>0</td><td>0</td><td>0</td><td style="border-left: 1px solid black;">0</td></tr> <tr><td>Trucks</td><td>0</td><td>0</td><td>0</td><td style="border-left: 1px solid black;">0</td></tr> <tr><td>Cars</td><td>19</td><td>0</td><td>5</td><td style="border-left: 1px solid black;">24</td></tr> <tr><td>Totals</td><td>19</td><td>0</td><td>5</td><td style="border-left: 1px solid black;"></td></tr> </table>	Buses	0	0	0	0	Trucks	0	0	0	0	Cars	19	0	5	24	Totals	19	0	5		<table style="border-collapse: collapse;"> <tr><td>Buses</td><td>0</td></tr> <tr><td>Trucks</td><td>1</td></tr> <tr><td>Cars</td><td>16</td></tr> <tr><td>Totals</td><td>17</td></tr> </table>	Buses	0	Trucks	1	Cars	16	Totals	17	East Leg Total: 394 East Entering: 183 East Peds: 0 Peds Cross: ☒
Buses	0	0	0	0																											
Trucks	0	0	0	0																											
Cars	19	0	5	24																											
Totals	19	0	5																												
Buses	0																														
Trucks	1																														
Cars	16																														
Totals	17																														
 <p style="text-align: center;">Florence Ave</p> <p style="text-align: center;">Wyandotte St E</p> <p style="text-align: center;">N W — S — E</p> <p style="text-align: center;">Wyandotte St E</p>																															
Peds Cross: ☒ West Peds: 0 West Entering: 221 West Leg Total: 421	<table style="border-collapse: collapse;"> <tr><td>Cars</td><td>0</td></tr> <tr><td>Trucks</td><td>0</td></tr> <tr><td>Buses</td><td>0</td></tr> <tr><td>Totals</td><td>0</td></tr> </table>	Cars	0	Trucks	0	Buses	0	Totals	0	<table style="border-collapse: collapse;"> <tr><td>Cars</td><td>0</td><td>0</td><td>0</td><td style="border-left: 1px solid black;">0</td></tr> <tr><td>Trucks</td><td>0</td><td>0</td><td>0</td><td style="border-left: 1px solid black;">0</td></tr> <tr><td>Buses</td><td>0</td><td>0</td><td>0</td><td style="border-left: 1px solid black;">0</td></tr> <tr><td>Totals</td><td>0</td><td>0</td><td>0</td><td style="border-left: 1px solid black;"></td></tr> </table>	Cars	0	0	0	0	Trucks	0	0	0	0	Buses	0	0	0	0	Totals	0	0	0		Peds Cross: ☒ South Peds: 0 South Entering: 0 South Leg Total: 0
Cars	0																														
Trucks	0																														
Buses	0																														
Totals	0																														
Cars	0	0	0	0																											
Trucks	0	0	0	0																											
Buses	0	0	0	0																											
Totals	0	0	0																												
Comments																															

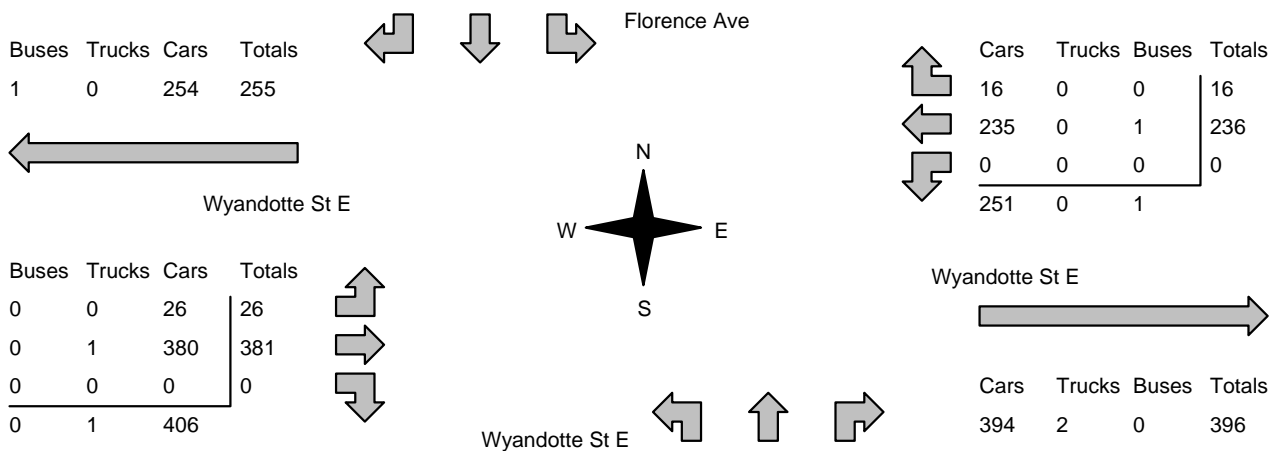
<h2>Afternoon Peak Diagram</h2>	Specified Period From: 15:00:00 To: 18:00:00	One Hour Peak From: 16:30:00 To: 17:30:00																																																										
Municipality: Windsor Site #: 2202100001 Intersection: Wyandotte St E & Florence Ave TFR File #: 1 Count date: 16-Feb-22	Weather conditions: Person counted: Person prepared: Person checked:																																																											
** Non-Signalized Intersection **		Major Road: Wyandotte St E runs W/E																																																										
North Leg Total: 76 North Entering: 34 North Peds: 2 Peds Cross: \boxtimes	<table style="border-collapse: collapse; margin: auto;"> <tr><td>Buses</td><td>0</td><td>0</td><td>0</td><td>0</td></tr> <tr><td>Trucks</td><td>0</td><td>0</td><td>1</td><td>1</td></tr> <tr><td>Cars</td><td>19</td><td>0</td><td>14</td><td>33</td></tr> <tr style="border-top: 1px solid black;"><td>Totals</td><td>19</td><td>0</td><td>15</td><td></td></tr> </table>	Buses	0	0	0	0	Trucks	0	0	1	1	Cars	19	0	14	33	Totals	19	0	15		<table style="border-collapse: collapse; margin: auto;"> <tr><td>Buses</td><td>0</td></tr> <tr><td>Trucks</td><td>0</td></tr> <tr><td>Cars</td><td>42</td></tr> <tr style="border-top: 1px solid black;"><td>Totals</td><td>42</td></tr> </table>	Buses	0	Trucks	0	Cars	42	Totals	42	East Leg Total: 648 East Entering: 252 East Peds: 0 Peds Cross: \boxtimes																													
Buses	0	0	0	0																																																								
Trucks	0	0	1	1																																																								
Cars	19	0	14	33																																																								
Totals	19	0	15																																																									
Buses	0																																																											
Trucks	0																																																											
Cars	42																																																											
Totals	42																																																											
																																																												
<table style="border-collapse: collapse; margin: auto;"> <tr><td>Buses</td><td>Trucks</td><td>Cars</td><td>Totals</td></tr> <tr><td>1</td><td>0</td><td>254</td><td>255</td></tr> </table>	Buses	Trucks	Cars	Totals	1	0	254	255	<table style="border-collapse: collapse; margin: auto;"> <tr><td>Cars</td><td>Trucks</td><td>Buses</td><td>Totals</td></tr> <tr><td>16</td><td>0</td><td>0</td><td>16</td></tr> <tr><td>235</td><td>0</td><td>1</td><td>236</td></tr> <tr><td>0</td><td>0</td><td>0</td><td>0</td></tr> <tr style="border-top: 1px solid black;"><td>251</td><td>0</td><td>1</td><td></td></tr> </table>	Cars	Trucks	Buses	Totals	16	0	0	16	235	0	1	236	0	0	0	0	251	0	1		<table style="border-collapse: collapse; margin: auto;"> <tr><td>Buses</td><td>Trucks</td><td>Cars</td><td>Totals</td></tr> <tr><td>0</td><td>0</td><td>26</td><td>26</td></tr> <tr><td>0</td><td>1</td><td>380</td><td>381</td></tr> <tr><td>0</td><td>0</td><td>0</td><td>0</td></tr> <tr style="border-top: 1px solid black;"><td>0</td><td>1</td><td>406</td><td></td></tr> </table>		Buses	Trucks	Cars	Totals	0	0	26	26	0	1	380	381	0	0	0	0	0	1	406		<table style="border-collapse: collapse; margin: auto;"> <tr><td>Cars</td><td>Trucks</td><td>Buses</td><td>Totals</td></tr> <tr><td>394</td><td>2</td><td>0</td><td>396</td></tr> </table>	Cars	Trucks	Buses	Totals	394	2	0	396
Buses	Trucks	Cars	Totals																																																									
1	0	254	255																																																									
Cars	Trucks	Buses	Totals																																																									
16	0	0	16																																																									
235	0	1	236																																																									
0	0	0	0																																																									
251	0	1																																																										
Buses	Trucks	Cars	Totals																																																									
0	0	26	26																																																									
0	1	380	381																																																									
0	0	0	0																																																									
0	1	406																																																										
Cars	Trucks	Buses	Totals																																																									
394	2	0	396																																																									
Peds Cross: \boxtimes West Peds: 0 West Entering: 407 West Leg Total: 662	<table style="border-collapse: collapse; margin: auto;"> <tr><td>Cars</td><td>0</td></tr> <tr><td>Trucks</td><td>0</td></tr> <tr><td>Buses</td><td>0</td></tr> <tr style="border-top: 1px solid black;"><td>Totals</td><td>0</td></tr> </table>	Cars	0	Trucks	0	Buses	0	Totals	0	<table style="border-collapse: collapse; margin: auto;"> <tr><td>Cars</td><td>0</td><td>0</td><td>0</td><td>0</td></tr> <tr><td>Trucks</td><td>0</td><td>0</td><td>0</td><td>0</td></tr> <tr><td>Buses</td><td>0</td><td>0</td><td>0</td><td>0</td></tr> <tr style="border-top: 1px solid black;"><td>Totals</td><td>0</td><td>0</td><td>0</td><td>0</td></tr> </table>	Cars	0	0	0	0	Trucks	0	0	0	0	Buses	0	0	0	0	Totals	0	0	0	0	Peds Cross: \boxtimes South Peds: 1 South Entering: 0 South Leg Total: 0																													
Cars	0																																																											
Trucks	0																																																											
Buses	0																																																											
Totals	0																																																											
Cars	0	0	0	0																																																								
Trucks	0	0	0	0																																																								
Buses	0	0	0	0																																																								
Totals	0	0	0	0																																																								
<h3>Comments</h3>																																																												

Total Count Diagram

Municipality: Windsor
Site #: 2202100001
Intersection: Wyandotte St E & Florence Ave
TFR File #: 1
Count date: 16-Feb-22

Weather conditions:

Person counted:
Person prepared:
Person checked:

**** Non-Signalized Intersection ****

Major Road: Wyandotte St E runs W/E

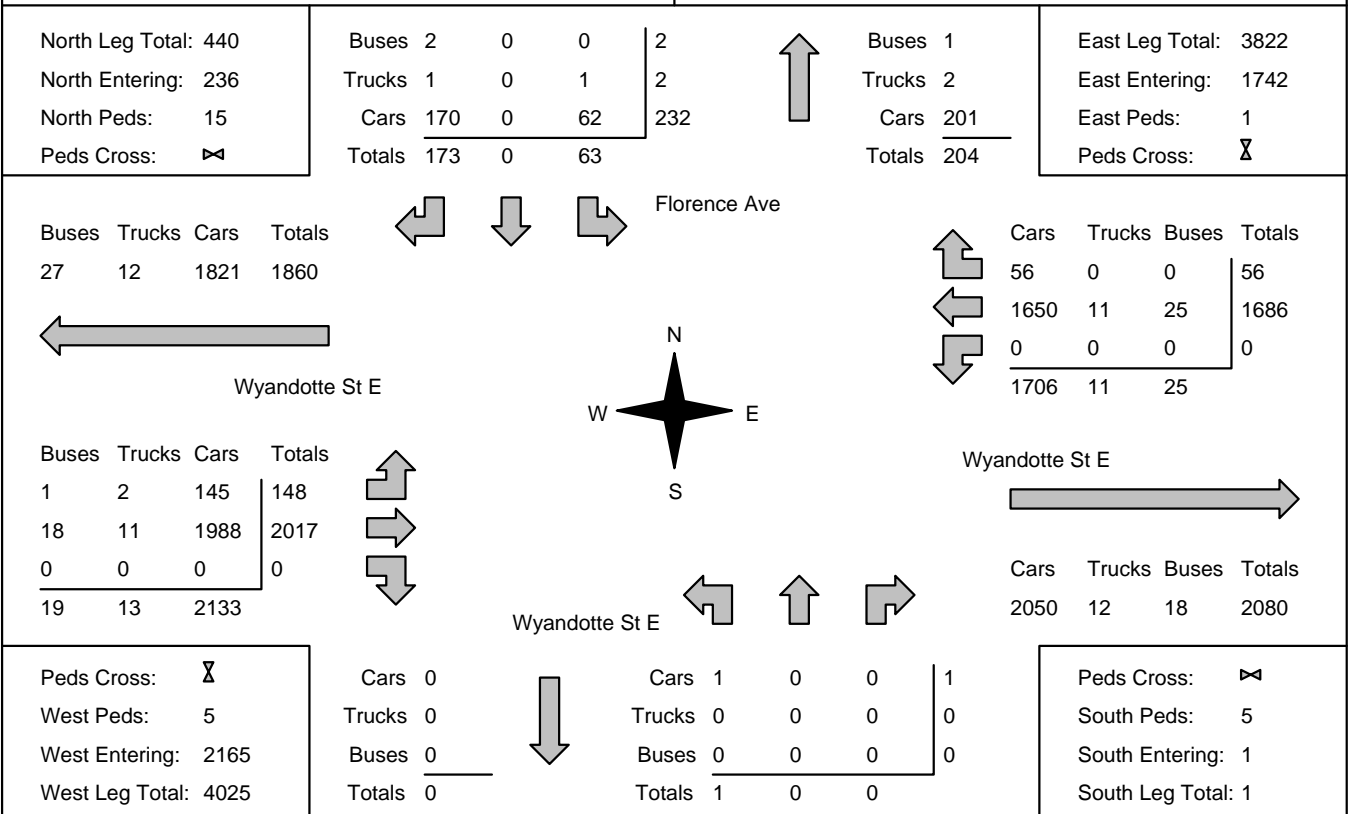

Comments

Traffic Count Summary

Intersection: Wyandotte St E & Florence Ave

Count Date: 16-Feb-22

Municipality: Windsor

North Approach Totals						North/South Total Approaches	South Approach Totals					
Hour Ending	Includes Cars, Trucks, & Buses				Total Peds		Hour Ending	Includes Cars, Trucks, & Buses				Total Peds
	Left	Thru	Right	Grand Total				Left	Thru	Right	Grand Total	
7:00:00	0	0	0	0	0	0	7:00:00	0	0	0	0	0
8:00:00	13	0	23	36	1	36	8:00:00	0	0	0	0	0
9:00:00	5	0	22	27	2	27	9:00:00	0	0	0	0	0
10:00:00	5	0	24	29	0	29	10:00:00	0	0	0	0	0
11:00:00	0	0	0	0	0	0	11:00:00	0	0	0	0	0
12:00:00	6	0	20	26	2	26	12:00:00	0	0	0	0	0
13:00:00	5	0	19	24	0	24	13:00:00	0	0	0	0	0
15:00:00	0	0	0	0	0	0	15:00:00	0	0	0	0	0
16:00:00	10	0	19	29	2	29	16:00:00	0	0	0	0	1
17:00:00	9	0	28	37	3	38	17:00:00	1	0	0	1	2
18:00:00	10	0	18	28	5	28	18:00:00	0	0	0	0	2
Totals:	63	0	173	236	15	237	S Totals:	1	0	0	1	5
East Approach Totals						East/West Total Approaches	West Approach Totals					
Hour Ending	Includes Cars, Trucks, & Buses				Total Peds		Hour Ending	Includes Cars, Trucks, & Buses				Total Peds
	Left	Thru	Right	Grand Total				Left	Thru	Right	Grand Total	
7:00:00	0	0	0	0	0	0	7:00:00	0	0	0	0	0
8:00:00	0	245	3	248	0	397	8:00:00	9	140	0	149	1
9:00:00	0	278	1	279	0	573	9:00:00	13	281	0	294	1
10:00:00	0	169	3	172	0	350	10:00:00	16	162	0	178	0
11:00:00	0	0	0	0	0	0	11:00:00	0	0	0	0	0
12:00:00	0	153	8	161	1	366	12:00:00	14	191	0	205	0
13:00:00	0	181	2	183	0	404	13:00:00	15	206	0	221	0
15:00:00	0	0	0	0	0	0	15:00:00	0	0	0	0	0
16:00:00	0	219	18	237	0	616	16:00:00	29	350	0	379	3
17:00:00	0	222	14	236	0	617	17:00:00	24	357	0	381	0
18:00:00	0	219	7	226	0	584	18:00:00	28	330	0	358	0
Totals:	0	1686	56	1742	1	3907	W Totals:	148	2017	0	2165	5
Calculated Values for Traffic Crossing Major Street												
Hours Ending:	8:00	9:00	10:00	12:00			13:00	16:00	17:00	18:00		
Crossing Values:	14	6	5	7			5	13	10	10		

Count Date: 16-Feb-22 Site #: 2202100001

Interval Time	Passenger Cars - North Approach						Trucks - North Approach						Buses - North Approach						Pedestrians	
	Left		Thru		Right		Left		Thru		Right		Left		Thru		Right		North Cross	
	Cum	Incr	Cum	Incr	Cum	Incr	Cum	Incr	Cum	Incr	Cum	Incr	Cum	Incr	Cum	Incr	Cum	Incr	Cum	Incr
7:00:00	0	0	0	0	0	0	0	0	0	0	0	0	0	0	0	0	0	0	0	0
7:15:00	4	4	0	0	5	5	0	0	0	0	0	0	0	0	0	0	0	0	0	0
7:30:00	6	2	0	0	11	6	0	0	0	0	0	0	0	0	0	0	0	0	0	0
7:45:00	8	2	0	0	17	6	0	0	0	0	0	0	0	0	0	0	0	0	0	0
8:00:00	13	5	0	0	23	6	0	0	0	0	0	0	0	0	0	0	0	0	1	1
8:15:00	14	1	0	0	32	9	0	0	0	0	0	0	0	0	0	0	0	0	2	1
8:30:00	15	1	0	0	35	3	0	0	0	0	0	0	0	0	0	0	1	1	2	0
8:45:00	17	2	0	0	39	4	0	0	0	0	0	0	0	0	0	1	0	2	0	0
9:00:00	18	1	0	0	44	5	0	0	0	0	0	0	0	0	0	1	0	3	1	0
9:15:00	19	1	0	0	50	6	0	0	0	0	0	0	0	0	0	1	0	3	0	0
9:30:00	22	3	0	0	59	9	0	0	0	0	0	0	0	0	0	1	0	3	0	0
9:45:00	23	1	0	0	64	5	0	0	0	0	0	0	0	0	0	1	0	3	0	0
10:00:00	23	0	0	0	68	4	0	0	0	0	0	0	0	0	0	1	0	3	0	0
10:15:00	23	0	0	0	68	0	0	0	0	0	0	0	0	0	0	1	0	3	0	0
11:00:00	23	0	0	0	68	0	0	0	0	0	0	0	0	0	0	1	0	3	0	0
11:15:00	26	3	0	0	72	4	0	0	0	0	0	0	0	0	0	1	0	5	2	0
11:30:00	27	1	0	0	76	4	0	0	0	0	1	1	0	0	0	1	0	5	0	0
11:45:00	27	0	0	0	79	3	0	0	0	0	1	0	0	0	0	1	0	5	0	0
12:00:00	29	2	0	0	87	8	0	0	0	0	1	0	0	0	0	1	0	5	0	0
12:15:00	31	2	0	0	90	3	0	0	0	0	1	0	0	0	0	1	0	5	0	0
12:30:00	31	0	0	0	93	3	0	0	0	0	1	0	0	0	0	1	0	5	0	0
12:45:00	32	1	0	0	96	3	0	0	0	0	1	0	0	0	0	1	0	5	0	0
13:00:00	34	2	0	0	106	10	0	0	0	0	1	0	0	0	0	1	0	5	0	0
13:15:00	34	0	0	0	106	0	0	0	0	0	1	0	0	0	0	1	0	5	0	0
15:00:00	34	0	0	0	106	0	0	0	0	0	1	0	0	0	0	1	0	5	0	0
15:15:00	35	1	0	0	113	7	0	0	0	0	1	0	0	0	0	1	0	5	0	0
15:30:00	38	3	0	0	119	6	0	0	0	0	1	0	0	0	0	1	0	5	0	0
15:45:00	43	5	0	0	121	2	0	0	0	0	1	0	0	0	0	1	0	7	2	0
16:00:00	44	1	0	0	125	4	0	0	0	0	1	0	0	0	0	1	0	7	0	0
16:15:00	46	2	0	0	132	7	0	0	0	0	1	0	0	0	0	2	1	8	1	0
16:30:00	47	1	0	0	140	8	0	0	0	0	1	0	0	0	0	2	0	9	1	0
16:45:00	49	2	0	0	144	4	0	0	0	0	1	0	0	0	0	2	0	9	0	0
17:00:00	53	4	0	0	152	8	0	0	0	0	1	0	0	0	0	2	0	10	1	0
17:15:00	60	7	0	0	155	3	1	1	0	0	1	0	0	0	0	2	0	10	0	0
17:30:00	61	1	0	0	159	4	1	0	0	0	1	0	0	0	0	2	0	11	1	0
17:45:00	61	0	0	0	162	3	1	0	0	0	1	0	0	0	0	2	0	14	3	0
18:00:00	62	1	0	0	170	8	1	0	0	0	1	0	0	0	0	2	0	15	1	0
18:15:00	62	0	0	0	170	0	1	0	0	0	1	0	0	0	0	2	0	15	0	0
18:15:15	62	0	0	0	170	0	1	0	0	0	1	0	0	0	0	2	0	15	0	0





Count Date: 16-Feb-22 Site #: 2202100001

Interval Time	Passenger Cars - East Approach						Trucks - East Approach						Buses - East Approach						Pedestrians	
	Left		Thru		Right		Left		Thru		Right		Left		Thru		Right		East Cross	
	Cum	Incr	Cum	Incr	Cum	Incr	Cum	Incr	Cum	Incr	Cum	Incr	Cum	Incr	Cum	Incr	Cum	Incr	Cum	Incr
7:00:00	0	0	0	0	0	0	0	0	0	0	0	0	0	0	0	0	0	0	0	0
7:15:00	0	0	25	25	1	1	0	0	0	0	0	0	0	0	3	3	0	0	0	0
7:30:00	0	0	74	49	1	0	0	0	0	0	0	0	0	0	3	0	0	0	0	0
7:45:00	0	0	134	60	2	1	0	0	1	1	0	0	0	0	7	4	0	0	0	0
8:00:00	0	0	234	100	3	1	0	0	1	0	0	0	0	0	10	3	0	0	0	0
8:15:00	0	0	331	97	3	0	0	0	1	0	0	0	0	0	10	0	0	0	0	0
8:30:00	0	0	374	43	4	1	0	0	1	0	0	0	0	0	11	1	0	0	0	0
8:45:00	0	0	444	70	4	0	0	0	1	0	0	0	0	0	12	1	0	0	0	0
9:00:00	0	0	507	63	4	0	0	0	1	0	0	0	0	0	15	3	0	0	0	0
9:15:00	0	0	557	50	5	1	0	0	2	1	0	0	0	0	15	0	0	0	0	0
9:30:00	0	0	584	27	6	1	0	0	3	1	0	0	0	0	15	0	0	0	0	0
9:45:00	0	0	629	45	7	1	0	0	3	0	0	0	0	0	15	0	0	0	0	0
10:00:00	0	0	672	43	7	0	0	0	5	2	0	0	0	0	15	0	0	0	0	0
10:15:00	0	0	672	0	7	0	0	0	5	0	0	0	0	0	15	0	0	0	0	0
11:00:00	0	0	672	0	7	0	0	0	5	0	0	0	0	0	15	0	0	0	0	0
11:15:00	0	0	703	31	8	1	0	0	6	1	0	0	0	0	15	0	0	0	0	0
11:30:00	0	0	741	38	12	4	0	0	6	0	0	0	0	0	16	1	0	0	0	0
11:45:00	0	0	779	38	14	2	0	0	6	0	0	0	0	0	16	0	0	0	1	1
12:00:00	0	0	823	44	15	1	0	0	6	0	0	0	0	0	16	0	0	0	1	0
12:15:00	0	0	869	46	15	0	0	0	6	0	0	0	0	0	16	0	0	0	1	0
12:30:00	0	0	904	35	16	1	0	0	6	0	0	0	0	0	16	0	0	0	1	0
12:45:00	0	0	955	51	16	0	0	0	6	0	0	0	0	0	17	1	0	0	1	0
13:00:00	0	0	1002	47	17	1	0	0	7	1	0	0	0	0	17	0	0	0	1	0
13:15:00	0	0	1002	0	17	0	0	0	7	0	0	0	0	0	17	0	0	0	1	0
15:00:00	0	0	1002	0	17	0	0	0	7	0	0	0	0	0	17	0	0	0	1	0
15:15:00	0	0	1054	52	21	4	0	0	8	1	0	0	0	0	18	1	0	0	1	0
15:30:00	0	0	1110	56	29	8	0	0	8	0	0	0	0	0	20	2	0	0	1	0
15:45:00	0	0	1169	59	33	4	0	0	10	2	0	0	0	0	22	2	0	0	1	0
16:00:00	0	0	1213	44	35	2	0	0	10	0	0	0	0	0	22	0	0	0	1	0
16:15:00	0	0	1263	50	35	0	0	0	10	0	0	0	0	0	24	2	0	0	1	0
16:30:00	0	0	1319	56	39	4	0	0	10	0	0	0	0	0	24	0	0	0	1	0
16:45:00	0	0	1380	61	45	6	0	0	10	0	0	0	0	0	24	0	0	0	1	0
17:00:00	0	0	1433	53	49	4	0	0	10	0	0	0	0	0	24	0	0	0	1	0
17:15:00	0	0	1487	54	52	3	0	0	10	0	0	0	0	0	25	1	0	0	1	0
17:30:00	0	0	1554	67	55	3	0	0	10	0	0	0	0	0	25	0	0	0	1	0
17:45:00	0	0	1620	66	55	0	0	0	10	0	0	0	0	0	25	0	0	0	1	0
18:00:00	0	0	1650	30	56	1	0	0	11	1	0	0	0	0	25	0	0	0	1	0
18:15:00	0	0	1650	0	56	0	0	0	11	0	0	0	0	0	25	0	0	0	1	0
18:15:15	0	0	1650	0	56	0	0	0	11	0	0	0	0	0	25	0	0	0	1	0

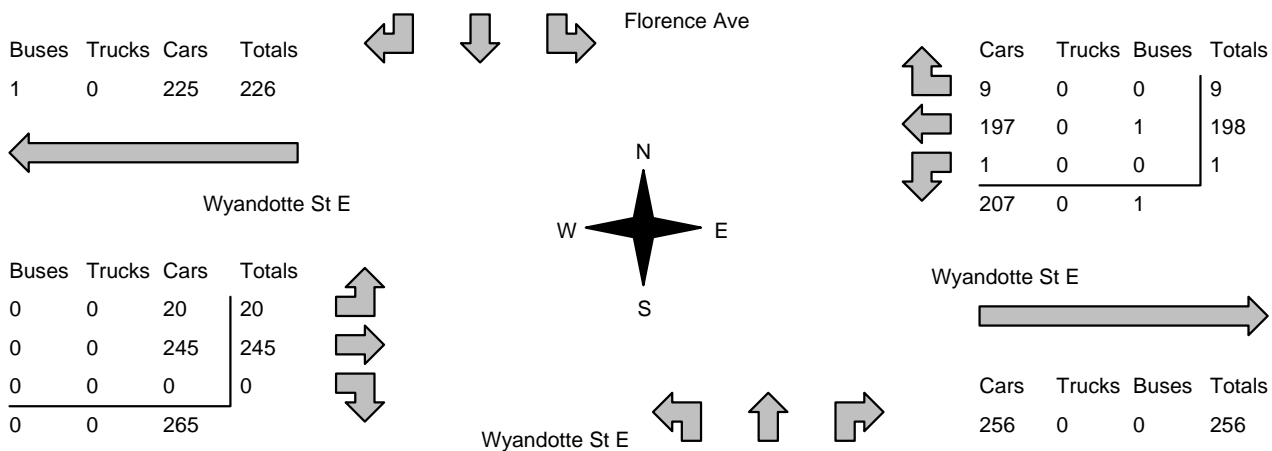

Count Date: 16-Feb-22 Site #: 2202100001

Interval Time	Passenger Cars - West Approach						Trucks - West Approach						Buses - West Approach						Pedestrians	
	Left		Thru		Right		Left		Thru		Right		Left		Thru		Right		West Cross	
	Cum	Incr	Cum	Incr	Cum	Incr	Cum	Incr	Cum	Incr	Cum	Incr	Cum	Incr	Cum	Incr	Cum	Incr	Cum	Incr
7:00:00	0	0	0	0	0	0	0	0	0	0	0	0	0	0	0	0	0	0	0	0
7:15:00	3	3	19	19	0	0	0	0	0	0	0	0	0	0	0	0	0	0	0	0
7:30:00	3	0	49	30	0	0	0	0	1	1	0	0	0	0	1	1	0	0	0	0
7:45:00	5	2	87	38	0	0	0	0	1	0	0	0	0	0	3	2	0	0	1	1
8:00:00	9	4	135	48	0	0	0	0	1	0	0	0	0	0	4	1	0	0	1	0
8:15:00	12	3	225	90	0	0	0	0	3	2	0	0	0	0	7	3	0	0	2	1
8:30:00	15	3	308	83	0	0	0	0	3	0	0	0	0	0	9	2	0	0	2	0
8:45:00	16	1	368	60	0	0	0	0	3	0	0	0	1	1	9	0	0	0	2	0
9:00:00	20	4	407	39	0	0	1	1	4	1	0	0	1	0	10	1	0	0	2	0
9:15:00	26	6	451	44	0	0	1	0	4	0	0	0	1	0	12	2	0	0	2	0
9:30:00	30	4	488	37	0	0	1	0	5	1	0	0	1	0	12	0	0	0	2	0
9:45:00	31	1	524	36	0	0	1	0	5	0	0	0	1	0	12	0	0	0	2	0
10:00:00	36	5	566	42	0	0	1	0	5	0	0	0	1	0	12	0	0	0	2	0
10:15:00	36	0	566	0	0	0	1	0	5	0	0	0	1	0	12	0	0	0	2	0
11:00:00	36	0	566	0	0	0	1	0	5	0	0	0	1	0	12	0	0	0	2	0
11:15:00	40	4	602	36	0	0	1	0	6	1	0	0	1	0	13	1	0	0	2	0
11:30:00	43	3	664	62	0	0	1	0	7	1	0	0	1	0	13	0	0	0	2	0
11:45:00	47	4	717	53	0	0	1	0	8	1	0	0	1	0	13	0	0	0	2	0
12:00:00	50	3	753	36	0	0	1	0	8	0	0	0	1	0	13	0	0	0	2	0
12:15:00	53	3	803	50	0	0	2	1	8	0	0	0	1	0	13	0	0	0	2	0
12:30:00	53	0	836	33	0	0	2	0	8	0	0	0	1	0	13	0	0	0	2	0
12:45:00	57	4	902	66	0	0	2	0	8	0	0	0	1	0	13	0	0	0	2	0
13:00:00	64	7	958	56	0	0	2	0	9	1	0	0	1	0	13	0	0	0	2	0
13:15:00	64	0	958	0	0	0	2	0	9	0	0	0	1	0	13	0	0	0	2	0
15:00:00	64	0	958	0	0	0	2	0	9	0	0	0	1	0	13	0	0	0	2	0
15:15:00	71	7	1045	87	0	0	2	0	9	0	0	0	1	0	13	0	0	0	2	0
15:30:00	75	4	1137	92	0	0	2	0	10	1	0	0	1	0	13	0	0	0	2	0
15:45:00	86	11	1219	82	0	0	2	0	10	0	0	0	1	0	13	0	0	0	2	0
16:00:00	93	7	1303	84	0	0	2	0	10	0	0	0	1	0	17	4	0	0	5	3
16:15:00	99	6	1386	83	0	0	2	0	10	0	0	0	1	0	18	1	0	0	5	0
16:30:00	105	6	1475	89	0	0	2	0	10	0	0	0	1	0	18	0	0	0	5	0
16:45:00	112	7	1556	81	0	0	2	0	10	0	0	0	1	0	18	0	0	0	5	0
17:00:00	117	5	1659	103	0	0	2	0	10	0	0	0	1	0	18	0	0	0	5	0
17:15:00	126	9	1740	81	0	0	2	0	10	0	0	0	1	0	18	0	0	0	5	0
17:30:00	131	5	1855	115	0	0	2	0	11	1	0	0	1	0	18	0	0	0	5	0
17:45:00	137	6	1931	76	0	0	2	0	11	0	0	0	1	0	18	0	0	0	5	0
18:00:00	145	8	1988	57	0	0	2	0	11	0	0	0	1	0	18	0	0	0	5	0
18:15:00	145	0	1988	0	0	0	2	0	11	0	0	0	1	0	18	0	0	0	5	0
18:15:15	145	0	1988	0	0	0	2	0	11	0	0	0	1	0	18	0	0	0	5	0

Mid-day Peak Diagram		Specified Period From: 12:00:00 To: 15:00:00	One Hour Peak From: 14:00:00 To: 15:00:00																													
Municipality: Windsor Site #: 2202100001 Intersection: Wyandotte St E & Florence Ave TFR File #: 1 Count date: 19-Feb-22		Weather conditions: Person counted: Person prepared: Person checked:																														
** Non-Signalized Intersection **		Major Road: Wyandotte St E runs W/E																														
North Leg Total: 68 North Entering: 39 North Peds: 1 Peds Cross: ☒	<table style="width:100%; border-collapse: collapse;"> <tr><td>Buses</td><td>0</td><td>0</td><td>0</td><td>0</td></tr> <tr><td>Trucks</td><td>0</td><td>0</td><td>0</td><td>0</td></tr> <tr><td>Cars</td><td>28</td><td>0</td><td>11</td><td>39</td></tr> <tr><td>Totals</td><td>28</td><td>0</td><td>11</td><td></td></tr> </table>	Buses	0	0	0	0	Trucks	0	0	0	0	Cars	28	0	11	39	Totals	28	0	11			<table style="width:100%; border-collapse: collapse;"> <tr><td>Buses</td><td>0</td></tr> <tr><td>Trucks</td><td>0</td></tr> <tr><td>Cars</td><td>29</td></tr> <tr><td>Totals</td><td>29</td></tr> </table>	Buses	0	Trucks	0	Cars	29	Totals	29	East Leg Total: 464 East Entering: 208 East Peds: 0 Peds Cross: ☒
Buses	0	0	0	0																												
Trucks	0	0	0	0																												
Cars	28	0	11	39																												
Totals	28	0	11																													
Buses	0																															
Trucks	0																															
Cars	29																															
Totals	29																															
																																
<table style="width:100%; border-collapse: collapse;"> <tr><td>Buses</td><td>Trucks</td><td>Cars</td><td>Totals</td></tr> <tr><td>1</td><td>0</td><td>225</td><td>226</td></tr> </table>	Buses	Trucks	Cars	Totals	1	0	225	226			<table style="width:100%; border-collapse: collapse;"> <tr><td>Cars</td><td>Trucks</td><td>Buses</td><td>Totals</td></tr> <tr><td>9</td><td>0</td><td>0</td><td>9</td></tr> <tr><td>197</td><td>0</td><td>1</td><td>198</td></tr> <tr><td>1</td><td>0</td><td>0</td><td>1</td></tr> <tr><td>207</td><td>0</td><td>1</td><td></td></tr> </table>	Cars	Trucks	Buses	Totals	9	0	0	9	197	0	1	198	1	0	0	1	207	0	1		
Buses	Trucks	Cars	Totals																													
1	0	225	226																													
Cars	Trucks	Buses	Totals																													
9	0	0	9																													
197	0	1	198																													
1	0	0	1																													
207	0	1																														
<table style="width:100%; border-collapse: collapse;"> <tr><td>Buses</td><td>Trucks</td><td>Cars</td><td>Totals</td></tr> <tr><td>0</td><td>0</td><td>20</td><td>20</td></tr> <tr><td>0</td><td>0</td><td>245</td><td>245</td></tr> <tr><td>0</td><td>0</td><td>0</td><td>0</td></tr> <tr><td>0</td><td>0</td><td>265</td><td></td></tr> </table>	Buses	Trucks	Cars	Totals	0	0	20	20	0	0	245	245	0	0	0	0	0	0	265				<table style="width:100%; border-collapse: collapse;"> <tr><td>Cars</td><td>Trucks</td><td>Buses</td><td>Totals</td></tr> <tr><td>256</td><td>0</td><td>0</td><td>256</td></tr> </table>	Cars	Trucks	Buses	Totals	256	0	0	256	
Buses	Trucks	Cars	Totals																													
0	0	20	20																													
0	0	245	245																													
0	0	0	0																													
0	0	265																														
Cars	Trucks	Buses	Totals																													
256	0	0	256																													
Peds Cross: ☒ West Peds: 0 West Entering: 265 West Leg Total: 491	<table style="width:100%; border-collapse: collapse;"> <tr><td>Cars</td><td>1</td></tr> <tr><td>Trucks</td><td>0</td></tr> <tr><td>Buses</td><td>0</td></tr> <tr><td>Totals</td><td>1</td></tr> </table>	Cars	1	Trucks	0	Buses	0	Totals	1		<table style="width:100%; border-collapse: collapse;"> <tr><td>Cars</td><td>0</td><td>0</td><td>0</td><td>0</td></tr> <tr><td>Trucks</td><td>0</td><td>0</td><td>0</td><td>0</td></tr> <tr><td>Buses</td><td>0</td><td>0</td><td>0</td><td>0</td></tr> <tr><td>Totals</td><td>0</td><td>0</td><td>0</td><td>0</td></tr> </table>	Cars	0	0	0	0	Trucks	0	0	0	0	Buses	0	0	0	0	Totals	0	0	0	0	Peds Cross: ☒ South Peds: 0 South Entering: 0 South Leg Total: 1
Cars	1																															
Trucks	0																															
Buses	0																															
Totals	1																															
Cars	0	0	0	0																												
Trucks	0	0	0	0																												
Buses	0	0	0	0																												
Totals	0	0	0	0																												
Comments																																

Total Count Diagram

Municipality: Windsor
Site #: 2202100001
Intersection: Wyandotte St E & Florence Ave
TFR File #: 1
Count date: 19-Feb-22

Weather conditions:

Person counted:
Person prepared:
Person checked:

**** Non-Signalized Intersection ****

Major Road: Wyandotte St E runs W/E

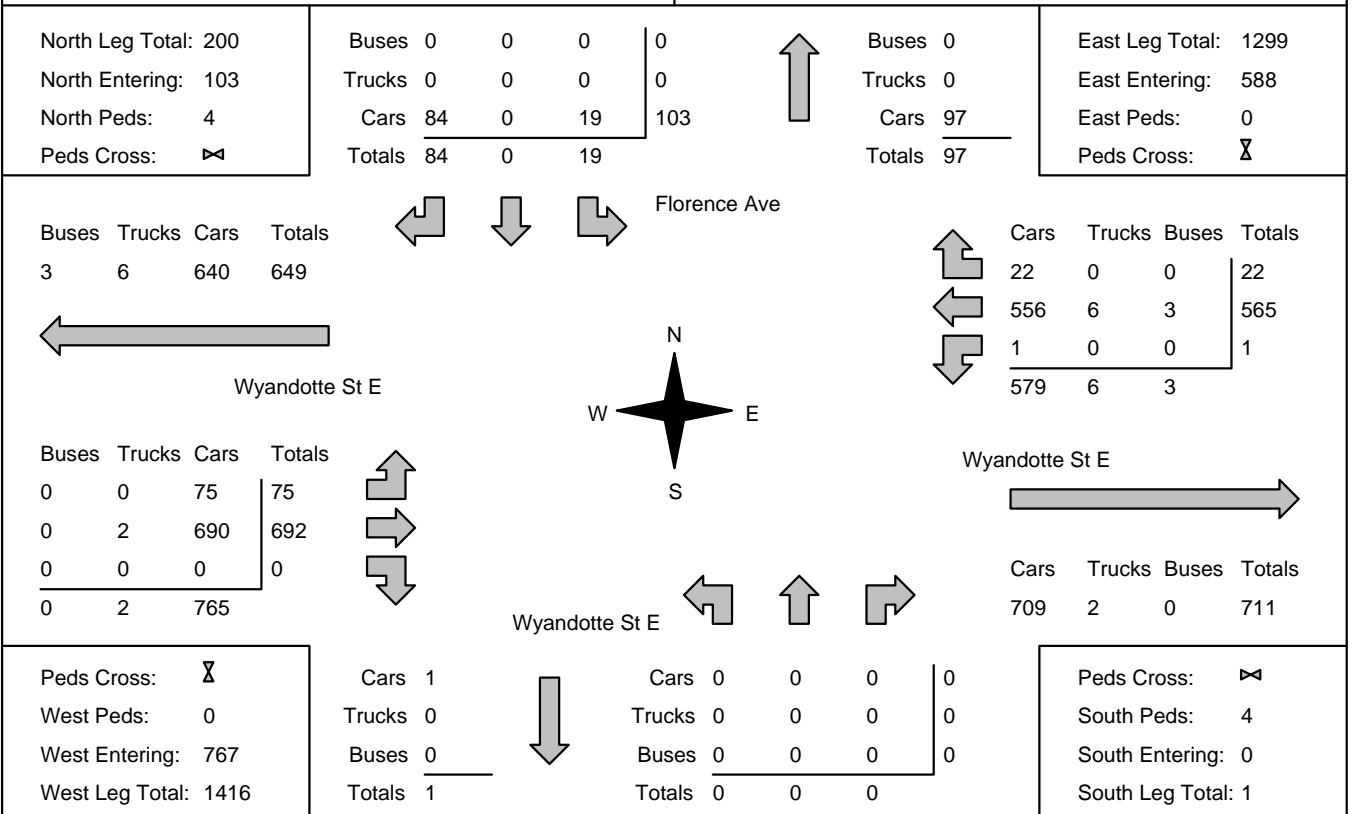





Comments



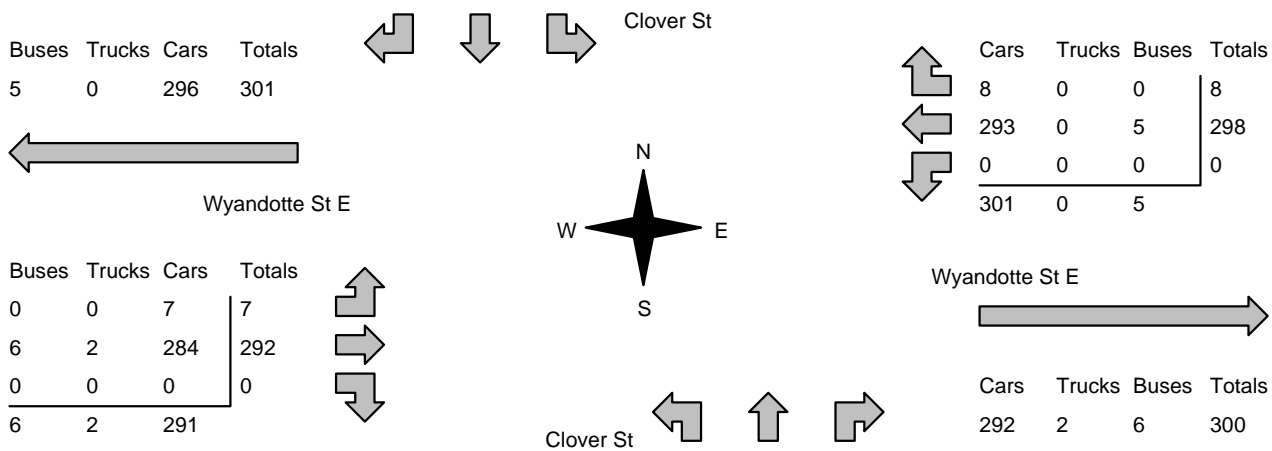



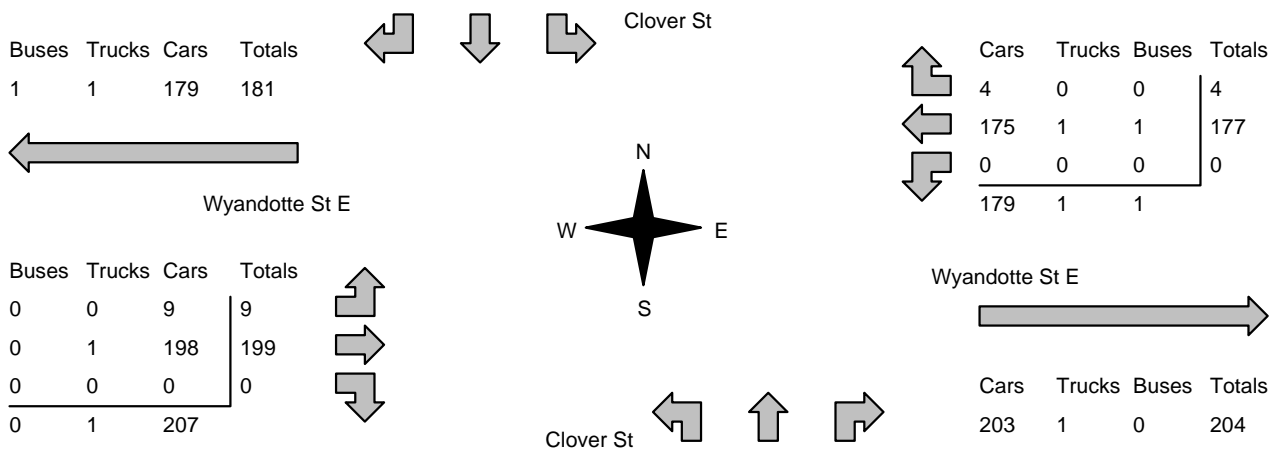







Traffic Count Summary

Intersection: Wyandotte St E & Florence Ave Count Date: 19-Feb-22 Municipality: Windsor

North Approach Totals						North/South Total Approaches	South Approach Totals					
Hour Ending	Includes Cars, Trucks, & Buses				Total Peds		Hour Ending	Includes Cars, Trucks, & Buses				Total Peds
	Left	Thru	Right	Grand Total				Left	Thru	Right	Grand Total	
12:00:00	0	0	0	0	0	0	12:00:00	0	0	0	0	0
13:00:00	3	0	29	32	1	32	13:00:00	0	0	0	0	0
14:00:00	5	0	27	32	2	32	14:00:00	0	0	0	0	4
15:00:00	11	0	28	39	1	39	15:00:00	0	0	0	0	0
Totals:	19	0	84	103	4	103	S Totals:	0	0	0	0	4
East Approach Totals						East/West Total Approaches	West Approach Totals					
Hour Ending	Includes Cars, Trucks, & Buses				Total Peds		Hour Ending	Includes Cars, Trucks, & Buses				Total Peds
	Left	Thru	Right	Grand Total				Left	Thru	Right	Grand Total	
12:00:00	0	0	0	0	0	0	12:00:00	0	0	0	0	0
13:00:00	0	176	8	184	0	439	13:00:00	30	225	0	255	0
14:00:00	0	191	5	196	0	443	14:00:00	25	222	0	247	0
15:00:00	1	198	9	208	0	473	15:00:00	20	245	0	265	0
Totals:	1	565	22	588	0	1355	W Totals:	75	692	0	767	0
Calculated Values for Traffic Crossing Major Street												
Hours Ending:	12:00	13:00	14:00	15:00					0:00	0:00	0:00	0:00
Crossing Values:	0	3	5	11					0	0	0	0

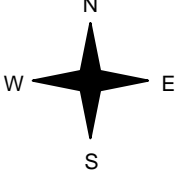
Morning Peak Diagram		Specified Period From: 7:00:00 To: 10:00:00	One Hour Peak From: 7:45:00 To: 8:45:00																																																								
Municipality: Windsor Site #: 2202100002 Intersection: Wyandotte St E & Clover St TFR File #: 1 Count date: 16-Feb-22		Weather conditions: Person counted: Person prepared: Person checked:																																																									
** Non-Signalized Intersection **		Major Road: Wyandotte St E runs W/E																																																									
North Leg Total: 26 North Entering: 11 North Peds: 1 Peds Cross: ☒	<table style="border-collapse: collapse;"> <tr><td>Buses</td><td>0</td><td>0</td><td>0</td><td style="border-left: 1px solid black;">0</td></tr> <tr><td>Trucks</td><td>0</td><td>0</td><td>0</td><td style="border-left: 1px solid black;">0</td></tr> <tr><td>Cars</td><td>3</td><td>0</td><td>8</td><td style="border-left: 1px solid black;">11</td></tr> <tr><td>Totals</td><td>3</td><td>0</td><td>8</td><td style="border-left: 1px solid black;"></td></tr> </table>	Buses	0	0	0	0	Trucks	0	0	0	0	Cars	3	0	8	11	Totals	3	0	8		<table style="border-collapse: collapse;"> <tr><td>Buses</td><td>0</td></tr> <tr><td>Trucks</td><td>0</td></tr> <tr><td>Cars</td><td>15</td></tr> <tr><td>Totals</td><td>15</td></tr> </table>	Buses	0	Trucks	0	Cars	15	Totals	15	East Leg Total: 606 East Entering: 306 East Peds: 1 Peds Cross: ☒																												
Buses	0	0	0	0																																																							
Trucks	0	0	0	0																																																							
Cars	3	0	8	11																																																							
Totals	3	0	8																																																								
Buses	0																																																										
Trucks	0																																																										
Cars	15																																																										
Totals	15																																																										
																																																											
<table style="border-collapse: collapse;"> <tr><td>Buses</td><td>Trucks</td><td>Cars</td><td>Totals</td></tr> <tr><td>5</td><td>0</td><td>296</td><td>301</td></tr> </table>	Buses	Trucks	Cars	Totals	5	0	296	301	<table style="border-collapse: collapse;"> <tr><td>Cars</td><td>Trucks</td><td>Buses</td><td>Totals</td></tr> <tr><td>8</td><td>0</td><td>0</td><td style="border-left: 1px solid black;">8</td></tr> <tr><td>293</td><td>0</td><td>5</td><td style="border-left: 1px solid black;">298</td></tr> <tr><td>0</td><td>0</td><td>0</td><td style="border-left: 1px solid black;">0</td></tr> <tr><td>301</td><td>0</td><td>5</td><td style="border-left: 1px solid black;"></td></tr> </table>	Cars	Trucks	Buses	Totals	8	0	0	8	293	0	5	298	0	0	0	0	301	0	5		<table style="border-collapse: collapse;"> <tr><td>Buses</td><td>Trucks</td><td>Cars</td><td>Totals</td></tr> <tr><td>0</td><td>0</td><td>7</td><td style="border-left: 1px solid black;">7</td></tr> <tr><td>6</td><td>2</td><td>284</td><td style="border-left: 1px solid black;">292</td></tr> <tr><td>0</td><td>0</td><td>0</td><td style="border-left: 1px solid black;">0</td></tr> <tr><td>6</td><td>2</td><td>291</td><td style="border-left: 1px solid black;"></td></tr> </table>	Buses	Trucks	Cars	Totals	0	0	7	7	6	2	284	292	0	0	0	0	6	2	291		<table style="border-collapse: collapse;"> <tr><td>Cars</td><td>Trucks</td><td>Buses</td><td>Totals</td></tr> <tr><td>292</td><td>2</td><td>6</td><td>300</td></tr> </table>	Cars	Trucks	Buses	Totals	292	2	6	300
Buses	Trucks	Cars	Totals																																																								
5	0	296	301																																																								
Cars	Trucks	Buses	Totals																																																								
8	0	0	8																																																								
293	0	5	298																																																								
0	0	0	0																																																								
301	0	5																																																									
Buses	Trucks	Cars	Totals																																																								
0	0	7	7																																																								
6	2	284	292																																																								
0	0	0	0																																																								
6	2	291																																																									
Cars	Trucks	Buses	Totals																																																								
292	2	6	300																																																								
Peds Cross: ☒ West Peds: 0 West Entering: 299 West Leg Total: 600	<table style="border-collapse: collapse;"> <tr><td>Cars</td><td>0</td></tr> <tr><td>Trucks</td><td>0</td></tr> <tr><td>Buses</td><td>0</td></tr> <tr><td>Totals</td><td>0</td></tr> </table>	Cars	0	Trucks	0	Buses	0	Totals	0	<table style="border-collapse: collapse;"> <tr><td>Cars</td><td>0</td><td>0</td><td>0</td><td style="border-left: 1px solid black;">0</td></tr> <tr><td>Trucks</td><td>0</td><td>0</td><td>0</td><td style="border-left: 1px solid black;">0</td></tr> <tr><td>Buses</td><td>0</td><td>0</td><td>0</td><td style="border-left: 1px solid black;">0</td></tr> <tr><td>Totals</td><td>0</td><td>0</td><td>0</td><td style="border-left: 1px solid black;"></td></tr> </table>	Cars	0	0	0	0	Trucks	0	0	0	0	Buses	0	0	0	0	Totals	0	0	0		Peds Cross: ☒ South Peds: 0 South Entering: 0 South Leg Total: 0																												
Cars	0																																																										
Trucks	0																																																										
Buses	0																																																										
Totals	0																																																										
Cars	0	0	0	0																																																							
Trucks	0	0	0	0																																																							
Buses	0	0	0	0																																																							
Totals	0	0	0																																																								
Comments																																																											

<h2>Mid-day Peak Diagram</h2>	Specified Period From: 11:00:00 To: 13:00:00	One Hour Peak From: 12:00:00 To: 13:00:00																			
Municipality: Windsor Site #: 2202100002 Intersection: Wyandotte St E & Clover St TFR File #: 1 Count date: 16-Feb-22	Weather conditions: Person counted: Person prepared: Person checked:																				
** Non-Signalized Intersection **	Major Road: Wyandotte St E runs W/E																				
<table style="width:100%; border-collapse: collapse;"> <tr><td style="width:50%;">North Leg Total: 22</td><td style="width:50%;">Buses 0 0 0 0</td></tr> <tr><td>North Entering: 9</td><td>Trucks 0 0 0 0</td></tr> <tr><td>North Peds: 1</td><td>Cars 4 0 5 9</td></tr> <tr><td>Peds Cross: ☒</td><td>Totals 4 0 5 9</td></tr> </table>	North Leg Total: 22	Buses 0 0 0 0	North Entering: 9	Trucks 0 0 0 0	North Peds: 1	Cars 4 0 5 9	Peds Cross: ☒	Totals 4 0 5 9		<table style="width:100%; border-collapse: collapse;"> <tr><td style="width:50%;">Buses 0</td><td style="width:50%;">East Leg Total: 385</td></tr> <tr><td>Trucks 0</td><td>East Entering: 181</td></tr> <tr><td>Cars 13</td><td>East Peds: 0</td></tr> <tr><td>Totals 13</td><td>Peds Cross: ☒</td></tr> </table>	Buses 0	East Leg Total: 385	Trucks 0	East Entering: 181	Cars 13	East Peds: 0	Totals 13	Peds Cross: ☒			
North Leg Total: 22	Buses 0 0 0 0																				
North Entering: 9	Trucks 0 0 0 0																				
North Peds: 1	Cars 4 0 5 9																				
Peds Cross: ☒	Totals 4 0 5 9																				
Buses 0	East Leg Total: 385																				
Trucks 0	East Entering: 181																				
Cars 13	East Peds: 0																				
Totals 13	Peds Cross: ☒																				
																					
<table style="width:100%; border-collapse: collapse;"> <tr><td style="width:50%;">Buses 1</td><td style="width:50%;">Cars 179</td></tr> <tr><td>Trucks 1</td><td>Totals 181</td></tr> <tr><td>Cars 9</td><td></td></tr> <tr><td>Trucks 1</td><td>199</td></tr> <tr><td>Cars 0</td><td>0</td></tr> <tr><td>Totals 1</td><td>207</td></tr> </table>	Buses 1	Cars 179	Trucks 1	Totals 181	Cars 9		Trucks 1	199	Cars 0	0	Totals 1	207	<table style="width:100%; border-collapse: collapse;"> <tr><td style="width:50%;">Cars 4</td><td style="width:50%;">Totals 4</td></tr> <tr><td>Trucks 0</td><td>177</td></tr> <tr><td>Buses 1</td><td>0</td></tr> <tr><td>Totals 1</td><td>179</td></tr> </table>	Cars 4	Totals 4	Trucks 0	177	Buses 1	0	Totals 1	179
Buses 1	Cars 179																				
Trucks 1	Totals 181																				
Cars 9																					
Trucks 1	199																				
Cars 0	0																				
Totals 1	207																				
Cars 4	Totals 4																				
Trucks 0	177																				
Buses 1	0																				
Totals 1	179																				
<table style="width:100%; border-collapse: collapse;"> <tr><td style="width:50%;">Peds Cross: ☒</td><td style="width:50%;">Cars 0</td></tr> <tr><td>West Peds: 0</td><td>Trucks 0</td></tr> <tr><td>West Entering: 208</td><td>Buses 0</td></tr> <tr><td>West Leg Total: 389</td><td>Totals 0</td></tr> </table>	Peds Cross: ☒	Cars 0	West Peds: 0	Trucks 0	West Entering: 208	Buses 0	West Leg Total: 389	Totals 0		<table style="width:100%; border-collapse: collapse;"> <tr><td style="width:50%;">Cars 0</td><td style="width:50%;">Peds Cross: ☒</td></tr> <tr><td>Trucks 0</td><td>South Peds: 0</td></tr> <tr><td>Buses 0</td><td>South Entering: 0</td></tr> <tr><td>Totals 0</td><td>South Leg Total: 0</td></tr> </table>	Cars 0	Peds Cross: ☒	Trucks 0	South Peds: 0	Buses 0	South Entering: 0	Totals 0	South Leg Total: 0			
Peds Cross: ☒	Cars 0																				
West Peds: 0	Trucks 0																				
West Entering: 208	Buses 0																				
West Leg Total: 389	Totals 0																				
Cars 0	Peds Cross: ☒																				
Trucks 0	South Peds: 0																				
Buses 0	South Entering: 0																				
Totals 0	South Leg Total: 0																				
<h2>Comments</h2>																					

<h2>Afternoon Peak Diagram</h2>	Specified Period From: 15:00:00 To: 18:00:00	One Hour Peak From: 16:30:00 To: 17:30:00																																																													
Municipality: Windsor Site #: 2202100002 Intersection: Wyandotte St E & Clover St TFR File #: 1 Count date: 16-Feb-22	Weather conditions: Person counted: Person prepared: Person checked:																																																														
** Non-Signalized Intersection **	Major Road: Wyandotte St E runs W/E																																																														
North Leg Total: 30 North Entering: 12 North Peds: 2 Peds Cross: ☒	<table style="border-collapse: collapse; margin: auto;"> <tr><td>Buses</td><td>0</td><td>0</td><td>0</td><td>0</td></tr> <tr><td>Trucks</td><td>0</td><td>0</td><td>1</td><td>1</td></tr> <tr><td>Cars</td><td>7</td><td>0</td><td>4</td><td>11</td></tr> <tr style="border-top: 1px solid black;"><td>Totals</td><td>7</td><td>0</td><td>5</td><td></td></tr> </table>	Buses	0	0	0	0	Trucks	0	0	1	1	Cars	7	0	4	11	Totals	7	0	5		 <table style="border-collapse: collapse; margin: auto;"> <tr><td>Buses</td><td>0</td></tr> <tr><td>Trucks</td><td>0</td></tr> <tr><td>Cars</td><td>18</td></tr> <tr style="border-top: 1px solid black;"><td>Totals</td><td>18</td></tr> </table>	Buses	0	Trucks	0	Cars	18	Totals	18	East Leg Total: 636 East Entering: 254 East Peds: 0 Peds Cross: ☒																																
Buses	0	0	0	0																																																											
Trucks	0	0	1	1																																																											
Cars	7	0	4	11																																																											
Totals	7	0	5																																																												
Buses	0																																																														
Trucks	0																																																														
Cars	18																																																														
Totals	18																																																														
<table style="border-collapse: collapse;"> <tr><td>Buses</td><td>Trucks</td><td>Cars</td><td>Totals</td></tr> <tr><td>1</td><td>0</td><td>251</td><td>252</td></tr> </table>	Buses	Trucks	Cars	Totals	1	0	251	252	   <p style="text-align: center;">Clover St</p>	   <table style="border-collapse: collapse; margin: auto;"> <tr><td>Cars</td><td>Trucks</td><td>Buses</td><td>Totals</td></tr> <tr><td>9</td><td>0</td><td>0</td><td>9</td></tr> <tr><td>244</td><td>0</td><td>1</td><td>245</td></tr> <tr><td>0</td><td>0</td><td>0</td><td>0</td></tr> <tr style="border-top: 1px solid black;"><td>253</td><td>0</td><td>1</td><td></td></tr> </table>	Cars	Trucks	Buses	Totals	9	0	0	9	244	0	1	245	0	0	0	0	253	0	1		<table style="border-collapse: collapse;"> <tr><td>Buses</td><td>Trucks</td><td>Cars</td><td>Totals</td></tr> <tr><td>0</td><td>0</td><td>9</td><td>9</td></tr> <tr><td>0</td><td>1</td><td>376</td><td>377</td></tr> <tr><td>0</td><td>0</td><td>0</td><td>0</td></tr> <tr style="border-top: 1px solid black;"><td>0</td><td>1</td><td>385</td><td></td></tr> </table>	Buses	Trucks	Cars	Totals	0	0	9	9	0	1	376	377	0	0	0	0	0	1	385		   <p style="text-align: center;">Wyandotte St E</p>	 <p style="text-align: center;">N S W E</p>	<p style="text-align: center;">Wyandotte St E</p> 	<table style="border-collapse: collapse;"> <tr><td>Cars</td><td>Trucks</td><td>Buses</td><td>Totals</td></tr> <tr><td>380</td><td>2</td><td>0</td><td>382</td></tr> </table>	Cars	Trucks	Buses	Totals	380	2	0	382
Buses	Trucks	Cars	Totals																																																												
1	0	251	252																																																												
Cars	Trucks	Buses	Totals																																																												
9	0	0	9																																																												
244	0	1	245																																																												
0	0	0	0																																																												
253	0	1																																																													
Buses	Trucks	Cars	Totals																																																												
0	0	9	9																																																												
0	1	376	377																																																												
0	0	0	0																																																												
0	1	385																																																													
Cars	Trucks	Buses	Totals																																																												
380	2	0	382																																																												
Peds Cross: ☒ West Peds: 1 West Entering: 386 West Leg Total: 638	 <table style="border-collapse: collapse; margin: auto;"> <tr><td>Cars</td><td>0</td></tr> <tr><td>Trucks</td><td>0</td></tr> <tr><td>Buses</td><td>0</td></tr> <tr style="border-top: 1px solid black;"><td>Totals</td><td>0</td></tr> </table>	Cars	0	Trucks	0	Buses	0	Totals	0	 <table style="border-collapse: collapse; margin: auto;"> <tr><td>Cars</td><td>0</td><td>0</td><td>0</td><td>0</td></tr> <tr><td>Trucks</td><td>0</td><td>0</td><td>0</td><td>0</td></tr> <tr><td>Buses</td><td>0</td><td>0</td><td>0</td><td>0</td></tr> <tr style="border-top: 1px solid black;"><td>Totals</td><td>0</td><td>0</td><td>0</td><td>0</td></tr> </table>	Cars	0	0	0	0	Trucks	0	0	0	0	Buses	0	0	0	0	Totals	0	0	0	0	Peds Cross: ☒ South Peds: 1 South Entering: 0 South Leg Total: 0																																
Cars	0																																																														
Trucks	0																																																														
Buses	0																																																														
Totals	0																																																														
Cars	0	0	0	0																																																											
Trucks	0	0	0	0																																																											
Buses	0	0	0	0																																																											
Totals	0	0	0	0																																																											
<h3>Comments</h3>																																																															

Total Count Diagram

Municipality: Windsor
Site #: 2202100002
Intersection: Wyandotte St E & Clover St
TFR File #: 1
Count date: 16-Feb-22

Weather conditions:

Person counted:
Person prepared:
Person checked:

**** Non-Signalized Intersection ****

Major Road: Wyandotte St E runs W/E

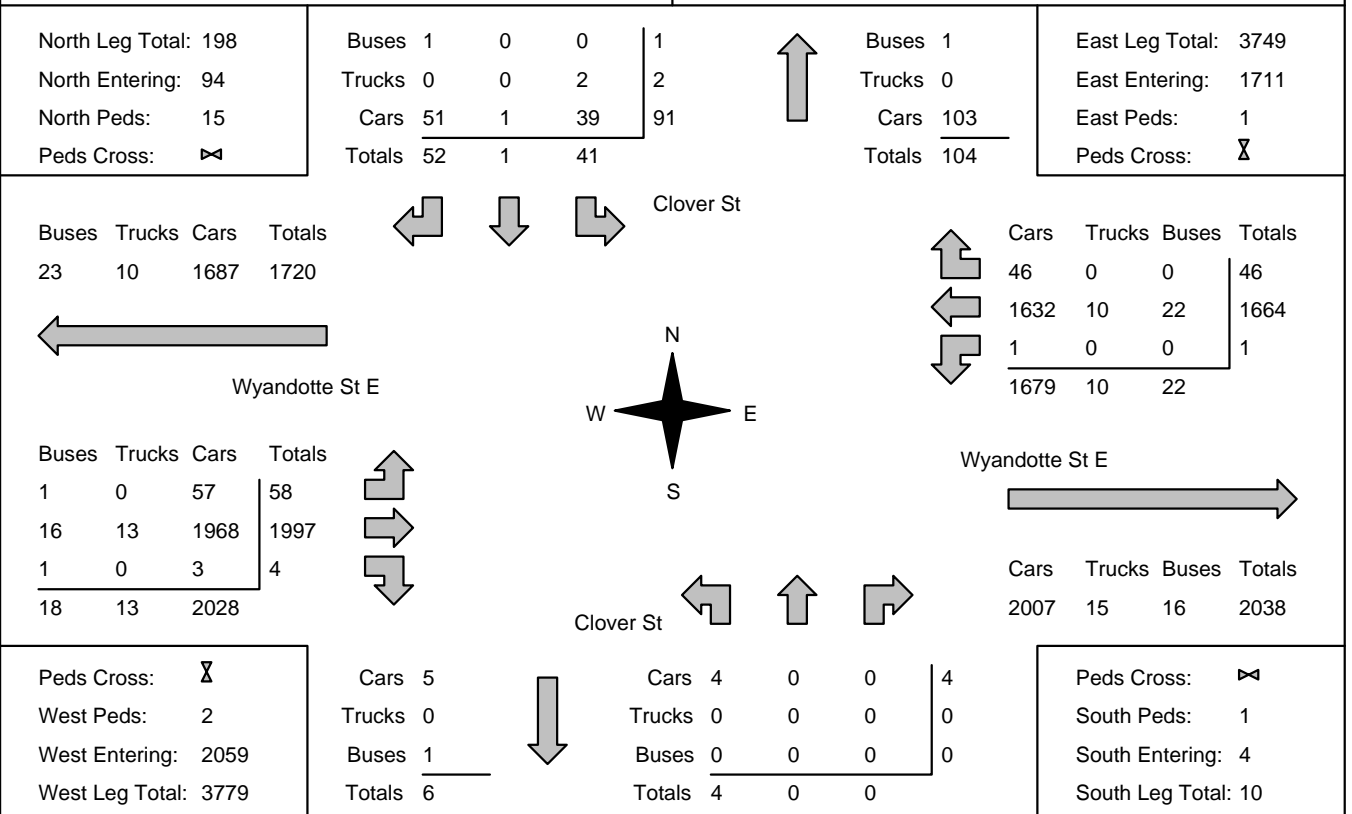

Comments

Traffic Count Summary

Intersection: Wyandotte St E & Clover St Count Date: 16-Feb-22 Municipality: Windsor

North Approach Totals						North/South Total Approaches	South Approach Totals					
Hour Ending	Includes Cars, Trucks, & Buses				Total Peds		Hour Ending	Includes Cars, Trucks, & Buses				Total Peds
	Left	Thru	Right	Grand Total				Left	Thru	Right	Grand Total	
7:00:00	0	0	0	0	0	0	7:00:00	0	0	0	0	0
8:00:00	5	0	6	11	1	11	8:00:00	0	0	0	0	0
9:00:00	7	0	6	13	1	13	9:00:00	0	0	0	0	0
10:00:00	4	0	10	14	1	14	10:00:00	0	0	0	0	0
11:00:00	0	0	0	0	0	0	11:00:00	0	0	0	0	0
12:00:00	3	0	4	7	2	8	12:00:00	1	0	0	1	0
13:00:00	5	0	4	9	1	9	13:00:00	0	0	0	0	0
15:00:00	0	0	0	0	0	0	15:00:00	0	0	0	0	0
16:00:00	4	0	8	12	3	14	16:00:00	2	0	0	2	0
17:00:00	10	0	4	14	1	15	17:00:00	1	0	0	1	0
18:00:00	3	1	10	14	5	14	18:00:00	0	0	0	0	1
Totals:	41	1	52	94	15	98	S Totals:	4	0	0	4	1
East Approach Totals						East/West Total Approaches	West Approach Totals					
Hour Ending	Includes Cars, Trucks, & Buses				Total Peds		Hour Ending	Includes Cars, Trucks, & Buses				Total Peds
	Left	Thru	Right	Grand Total				Left	Thru	Right	Grand Total	
7:00:00	0	0	0	0	0	0	7:00:00	0	0	0	0	0
8:00:00	0	236	3	239	0	394	8:00:00	1	154	0	155	0
9:00:00	0	267	7	274	1	562	9:00:00	7	281	0	288	0
10:00:00	0	156	1	157	0	323	10:00:00	5	161	0	166	0
11:00:00	0	0	0	0	0	0	11:00:00	0	0	0	0	0
12:00:00	0	154	6	160	0	358	12:00:00	9	189	0	198	0
13:00:00	0	177	4	181	0	389	13:00:00	9	199	0	208	0
15:00:00	0	0	0	0	0	0	15:00:00	0	0	0	0	0
16:00:00	1	223	7	231	0	584	16:00:00	13	337	3	353	1
17:00:00	0	235	10	245	0	604	17:00:00	7	351	1	359	1
18:00:00	0	216	8	224	0	556	18:00:00	7	325	0	332	0
Totals:	1	1664	46	1711	1	3770	W Totals:	58	1997	4	2059	2
Calculated Values for Traffic Crossing Major Street												
Hours Ending:	8:00	9:00	10:00	12:00			13:00	16:00	17:00	18:00		
Crossing Values:	5	8	4	4			5	7	12	4		



Count Date: 16-Feb-22 Site #: 2202100002

Interval Time	Passenger Cars - North Approach						Trucks - North Approach						Buses - North Approach						Pedestrians	
	Left		Thru		Right		Left		Thru		Right		Left		Thru		Right		North Cross	
	Cum	Incr	Cum	Incr	Cum	Incr	Cum	Incr	Cum	Incr	Cum	Incr	Cum	Incr	Cum	Incr	Cum	Incr	Cum	Incr
7:00:00	0	0	0	0	0	0	0	0	0	0	0	0	0	0	0	0	0	0	0	0
7:15:00	1	1	0	0	2	2	0	0	0	0	0	0	0	0	0	0	0	0	1	1
7:30:00	2	1	0	0	2	0	0	0	0	0	0	0	0	0	0	0	0	0	1	0
7:45:00	4	2	0	0	5	3	0	0	0	0	0	0	0	0	0	0	1	1	1	0
8:00:00	5	1	0	0	5	0	0	0	0	0	0	0	0	0	0	1	0	1	0	
8:15:00	8	3	0	0	6	1	0	0	0	0	0	0	0	0	1	0	2	1		
8:30:00	8	0	0	0	6	0	0	0	0	0	0	0	0	0	1	0	2	0		
8:45:00	12	4	0	0	8	2	0	0	0	0	0	0	0	0	1	0	2	0		
9:00:00	12	0	0	0	11	3	0	0	0	0	0	0	0	0	1	0	2	0		
9:15:00	14	2	0	0	16	5	0	0	0	0	0	0	0	0	1	0	3	1		
9:30:00	14	0	0	0	16	0	0	0	0	0	0	0	0	0	1	0	3	0		
9:45:00	15	1	0	0	18	2	1	1	0	0	0	0	0	0	1	0	3	0		
10:00:00	15	0	0	0	21	3	1	0	0	0	0	0	0	0	1	0	3	0		
10:15:00	15	0	0	0	21	0	1	0	0	0	0	0	0	0	1	0	3	0		
11:00:00	15	0	0	0	21	0	1	0	0	0	0	0	0	0	1	0	3	0		
11:15:00	16	1	0	0	23	2	1	0	0	0	0	0	0	0	1	0	5	2		
11:30:00	16	0	0	0	24	1	1	0	0	0	0	0	0	0	1	0	5	0		
11:45:00	17	1	0	0	25	1	1	0	0	0	0	0	0	0	1	0	5	0		
12:00:00	18	1	0	0	25	0	1	0	0	0	0	0	0	0	1	0	5	0		
12:15:00	19	1	0	0	26	1	1	0	0	0	0	0	0	0	1	0	5	0		
12:30:00	21	2	0	0	27	1	1	0	0	0	0	0	0	0	1	0	5	0		
12:45:00	22	1	0	0	28	1	1	0	0	0	0	0	0	0	1	0	5	0		
13:00:00	23	1	0	0	29	1	1	0	0	0	0	0	0	0	1	0	6	1		
13:15:00	23	0	0	0	29	0	1	0	0	0	0	0	0	0	1	0	6	0		
15:00:00	23	0	0	0	29	0	1	0	0	0	0	0	0	0	1	0	6	0		
15:15:00	26	3	0	0	32	3	1	0	0	0	0	0	0	0	1	0	6	0		
15:30:00	27	1	0	0	34	2	1	0	0	0	0	0	0	0	1	0	6	0		
15:45:00	27	0	0	0	37	3	1	0	0	0	0	0	0	0	1	0	8	2		
16:00:00	27	0	0	0	37	0	1	0	0	0	0	0	0	0	1	0	9	1		
16:15:00	28	1	0	0	38	1	1	0	0	0	0	0	0	0	1	0	9	0		
16:30:00	33	5	0	0	40	2	1	0	0	0	0	0	0	0	1	0	9	0		
16:45:00	35	2	0	0	40	0	1	0	0	0	0	0	0	0	1	0	9	0		
17:00:00	37	2	0	0	41	1	1	0	0	0	0	0	0	0	1	0	10	1		
17:15:00	37	0	0	0	46	5	2	1	0	0	0	0	0	0	1	0	10	0		
17:30:00	37	0	0	0	47	1	2	0	0	0	0	0	0	0	1	0	11	1		
17:45:00	39	2	0	0	49	2	2	0	0	0	0	0	0	0	1	0	12	1		
18:00:00	39	0	1	1	51	2	2	0	0	0	0	0	0	0	1	0	15	3		
18:15:00	39	0	1	0	51	0	2	0	0	0	0	0	0	0	1	0	15	0		
18:15:15	39	0	1	0	51	0	2	0	0	0	0	0	0	0	1	0	15	0		



Count Date: 16-Feb-22 Site #: 2202100002

Interval Time	Passenger Cars - East Approach						Trucks - East Approach						Buses - East Approach						Pedestrians	
	Left		Thru		Right		Left		Thru		Right		Left		Thru		Right		East Cross	
	Cum	Incr	Cum	Incr	Cum	Incr	Cum	Incr	Cum	Incr	Cum	Incr	Cum	Incr	Cum	Incr	Cum	Incr	Cum	Incr
7:00:00	0	0	0	0	0	0	0	0	0	0	0	0	0	0	0	0	0	0	0	0
7:15:00	0	0	23	23	0	0	0	0	0	0	0	0	0	0	3	3	0	0	0	0
7:30:00	0	0	73	50	1	1	0	0	0	0	0	0	0	0	3	0	0	0	0	0
7:45:00	0	0	137	64	2	1	0	0	1	1	0	0	0	0	6	3	0	0	0	0
8:00:00	0	0	226	89	3	1	0	0	1	0	0	0	0	0	9	3	0	0	0	0
8:15:00	0	0	321	95	4	1	0	0	1	0	0	0	0	0	9	0	0	0	0	0
8:30:00	0	0	364	43	6	2	0	0	1	0	0	0	0	0	10	1	0	0	0	0
8:45:00	0	0	430	66	10	4	0	0	1	0	0	0	0	0	11	1	0	0	1	1
9:00:00	0	0	489	59	10	0	0	0	1	0	0	0	0	0	13	2	0	0	1	0
9:15:00	0	0	534	45	10	0	0	0	2	1	0	0	0	0	13	0	0	0	1	0
9:30:00	0	0	561	27	10	0	0	0	3	1	0	0	0	0	13	0	0	0	1	0
9:45:00	0	0	604	43	10	0	0	0	3	0	0	0	0	0	13	0	0	0	1	0
10:00:00	0	0	641	37	11	1	0	0	5	2	0	0	0	0	13	0	0	0	1	0
10:15:00	0	0	641	0	11	0	0	0	5	0	0	0	0	0	13	0	0	0	1	0
11:00:00	0	0	641	0	11	0	0	0	5	0	0	0	0	0	13	0	0	0	1	0
11:15:00	0	0	670	29	11	0	0	0	6	1	0	0	0	0	13	0	0	0	1	0
11:30:00	0	0	709	39	12	1	0	0	6	0	0	0	0	0	14	1	0	0	1	0
11:45:00	0	0	748	39	15	3	0	0	6	0	0	0	0	0	14	0	0	0	1	0
12:00:00	0	0	793	45	17	2	0	0	6	0	0	0	0	0	14	0	0	0	1	0
12:15:00	0	0	839	46	18	1	0	0	6	0	0	0	0	0	14	0	0	0	1	0
12:30:00	0	0	870	31	19	1	0	0	6	0	0	0	0	0	14	0	0	0	1	0
12:45:00	0	0	922	52	20	1	0	0	6	0	0	0	0	0	15	1	0	0	1	0
13:00:00	0	0	968	46	21	1	0	0	7	1	0	0	0	0	15	0	0	0	1	0
13:15:00	0	0	968	0	21	0	0	0	7	0	0	0	0	0	15	0	0	0	1	0
15:00:00	0	0	968	0	21	0	0	0	7	0	0	0	0	0	15	0	0	0	1	0
15:15:00	1	1	1020	52	26	5	0	0	7	0	0	0	0	0	16	1	0	0	1	0
15:30:00	1	0	1087	67	27	1	0	0	7	0	0	0	0	0	18	2	0	0	1	0
15:45:00	1	0	1142	55	28	1	0	0	9	2	0	0	0	0	19	1	0	0	1	0
16:00:00	1	0	1185	43	28	0	0	0	9	0	0	0	0	0	19	0	0	0	1	0
16:15:00	1	0	1238	53	32	4	0	0	9	0	0	0	0	0	21	2	0	0	1	0
16:30:00	1	0	1299	61	33	1	0	0	9	0	0	0	0	0	21	0	0	0	1	0
16:45:00	1	0	1360	61	35	2	0	0	9	0	0	0	0	0	21	0	0	0	1	0
17:00:00	1	0	1418	58	38	3	0	0	9	0	0	0	0	0	21	0	0	0	1	0
17:15:00	1	0	1471	53	39	1	0	0	9	0	0	0	0	0	22	1	0	0	1	0
17:30:00	1	0	1543	72	42	3	0	0	9	0	0	0	0	0	22	0	0	0	1	0
17:45:00	1	0	1605	62	44	2	0	0	9	0	0	0	0	0	22	0	0	0	1	0
18:00:00	1	0	1632	27	46	2	0	0	10	1	0	0	0	0	22	0	0	0	1	0
18:15:00	1	0	1632	0	46	0	0	0	10	0	0	0	0	0	22	0	0	0	1	0
18:15:15	1	0	1632	0	46	0	0	0	10	0	0	0	0	0	22	0	0	0	1	0



Count Date: 16-Feb-22 Site #: 2202100002

Interval Time	Passenger Cars - West Approach						Trucks - West Approach						Buses - West Approach						Pedestrians	
	Left		Thru		Right		Left		Thru		Right		Left		Thru		Right		West Cross	
	Cum	Incr	Cum	Incr	Cum	Incr	Cum	Incr	Cum	Incr	Cum	Incr	Cum	Incr	Cum	Incr	Cum	Incr	Cum	Incr
7:00:00	0	0	0	0	0	0	0	0	0	0	0	0	0	0	0	0	0	0	0	0
7:15:00	0	0	22	22	0	0	0	0	0	0	0	0	0	0	0	0	0	0	0	0
7:30:00	0	0	53	31	0	0	0	0	1	1	0	0	1	1	0	0	0	0	0	0
7:45:00	0	0	97	44	0	0	0	0	1	0	0	0	1	0	2	2	0	0	0	0
8:00:00	0	0	150	53	0	0	0	0	1	0	0	0	1	0	3	1	0	0	0	0
8:15:00	2	2	241	91	0	0	0	0	3	2	0	0	1	0	6	3	0	0	0	0
8:30:00	5	3	320	79	0	0	0	0	3	0	0	0	1	0	8	2	0	0	0	0
8:45:00	7	2	381	61	0	0	0	0	3	0	0	0	1	0	8	0	0	0	0	0
9:00:00	7	0	423	42	0	0	0	0	3	0	0	0	1	0	9	1	0	0	0	0
9:15:00	9	2	464	41	0	0	0	0	4	1	0	0	1	0	11	2	0	0	0	0
9:30:00	9	0	504	40	0	0	0	0	5	1	0	0	1	0	11	0	0	0	0	0
9:45:00	10	1	541	37	0	0	0	0	5	0	0	0	1	0	11	0	0	0	0	0
10:00:00	12	2	579	38	0	0	0	0	6	1	0	0	1	0	11	0	0	0	0	0
10:15:00	12	0	579	0	0	0	0	0	6	0	0	0	1	0	11	0	0	0	0	0
11:00:00	12	0	579	0	0	0	0	0	6	0	0	0	1	0	11	0	0	0	0	0
11:15:00	13	1	617	38	0	0	0	0	8	2	0	0	1	0	11	0	0	0	0	0
11:30:00	17	4	675	58	0	0	0	0	9	1	0	0	1	0	11	0	0	0	0	0
11:45:00	20	3	727	52	0	0	0	0	10	1	0	0	1	0	11	0	0	0	0	0
12:00:00	21	1	764	37	0	0	0	0	10	0	0	0	1	0	11	0	0	0	0	0
12:15:00	22	1	814	50	0	0	0	0	10	0	0	0	1	0	11	0	0	0	0	0
12:30:00	23	1	843	29	0	0	0	0	10	0	0	0	1	0	11	0	0	0	0	0
12:45:00	29	6	901	58	0	0	0	0	10	0	0	0	1	0	11	0	0	0	0	0
13:00:00	30	1	962	61	0	0	0	0	11	1	0	0	1	0	11	0	0	0	0	0
13:15:00	30	0	962	0	0	0	0	0	11	0	0	0	1	0	11	0	0	0	0	0
15:00:00	30	0	962	0	0	0	0	0	11	0	0	0	1	0	11	0	0	0	0	0
15:15:00	33	3	1049	87	0	0	0	0	11	0	0	0	1	0	11	0	1	1	0	0
15:30:00	35	2	1133	84	0	0	0	0	12	1	0	0	1	0	11	0	1	0	0	0
15:45:00	40	5	1213	80	1	1	0	0	12	0	0	0	1	0	11	0	1	0	0	0
16:00:00	43	3	1294	81	2	1	0	0	12	0	0	0	1	0	15	4	1	0	1	1
16:15:00	44	1	1375	81	3	1	0	0	12	0	0	0	1	0	16	1	1	0	1	0
16:30:00	45	1	1465	90	3	0	0	0	12	0	0	0	1	0	16	0	1	0	1	0
16:45:00	47	2	1544	79	3	0	0	0	12	0	0	0	1	0	16	0	1	0	2	1
17:00:00	50	3	1644	100	3	0	0	0	12	0	0	0	1	0	16	0	1	0	2	0
17:15:00	53	3	1731	87	3	0	0	0	12	0	0	0	1	0	16	0	1	0	2	0
17:30:00	54	1	1841	110	3	0	0	0	13	1	0	0	1	0	16	0	1	0	2	0
17:45:00	57	3	1915	74	3	0	0	0	13	0	0	0	1	0	16	0	1	0	2	0
18:00:00	57	0	1968	53	3	0	0	0	13	0	0	0	1	0	16	0	1	0	2	0
18:15:00	57	0	1968	0	3	0	0	0	13	0	0	0	1	0	16	0	1	0	2	0
18:15:15	57	0	1968	0	3	0	0	0	13	0	0	0	1	0	16	0	1	0	2	0

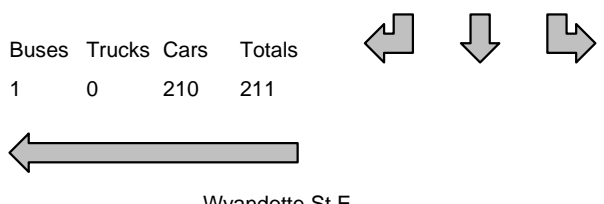
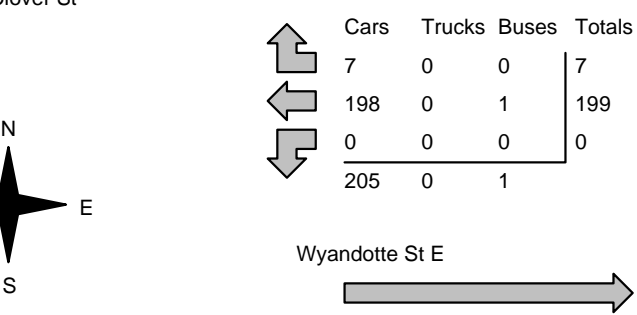
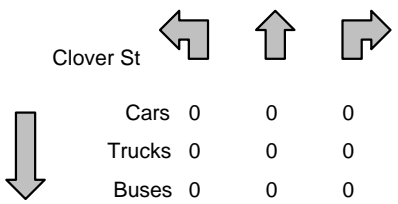
<h2>Mid-day Peak Diagram</h2>	Specified Period From: 12:00:00 To: 15:00:00	One Hour Peak From: 14:00:00 To: 15:00:00																														
Municipality: Windsor Site #: 2202100002 Intersection: Wyandotte St E & Clover St TFR File #: 1 Count date: 19-Feb-22	Weather conditions: Person counted: Person prepared: Person checked:																															
** Non-Signalized Intersection **	Major Road: Wyandotte St E runs W/E																															
North Leg Total: 34 North Entering: 17 North Peds: 1 Peds Cross: ☒	<table style="border-collapse: collapse; margin: auto;"> <tr><td>Buses</td><td>0</td><td>0</td><td>0</td><td style="border-left: 1px solid black;">0</td></tr> <tr><td>Trucks</td><td>0</td><td>0</td><td>0</td><td style="border-left: 1px solid black;">0</td></tr> <tr><td>Cars</td><td>12</td><td>0</td><td>5</td><td style="border-left: 1px solid black;">17</td></tr> <tr><td>Totals</td><td>12</td><td>0</td><td>5</td><td style="border-left: 1px solid black;"></td></tr> </table>	Buses	0	0	0	0	Trucks	0	0	0	0	Cars	12	0	5	17	Totals	12	0	5		<table style="border-collapse: collapse; margin: auto;"> <tr><td>Buses</td><td>0</td></tr> <tr><td>Trucks</td><td>0</td></tr> <tr><td>Cars</td><td>17</td></tr> <tr><td>Totals</td><td>17</td></tr> </table>	Buses	0	Trucks	0	Cars	17	Totals	17	East Leg Total: 451 East Entering: 206 East Peds: 0 Peds Cross: ☒	
Buses	0	0	0	0																												
Trucks	0	0	0	0																												
Cars	12	0	5	17																												
Totals	12	0	5																													
Buses	0																															
Trucks	0																															
Cars	17																															
Totals	17																															
<table style="border-collapse: collapse; margin: auto;"> <tr><td>Buses</td><td>Trucks</td><td>Cars</td><td>Totals</td></tr> <tr><td>1</td><td>0</td><td>210</td><td>211</td></tr> </table>	Buses	Trucks	Cars	Totals	1	0	210	211		<table style="border-collapse: collapse; margin: auto;"> <tr><td>Cars</td><td>Trucks</td><td>Buses</td><td>Totals</td></tr> <tr><td>7</td><td>0</td><td>0</td><td style="border-left: 1px solid black;">7</td></tr> <tr><td>198</td><td>0</td><td>1</td><td style="border-left: 1px solid black;">199</td></tr> <tr><td>0</td><td>0</td><td>0</td><td style="border-left: 1px solid black;">0</td></tr> <tr><td>205</td><td>0</td><td>1</td><td style="border-left: 1px solid black;"></td></tr> </table>	Cars	Trucks	Buses	Totals	7	0	0	7	198	0	1	199	0	0	0	0	205	0	1			
Buses	Trucks	Cars	Totals																													
1	0	210	211																													
Cars	Trucks	Buses	Totals																													
7	0	0	7																													
198	0	1	199																													
0	0	0	0																													
205	0	1																														
Peds Cross: ☒ West Peds: 0 West Entering: 251 West Leg Total: 462	<table style="border-collapse: collapse; margin: auto;"> <tr><td>Cars</td><td>1</td></tr> <tr><td>Trucks</td><td>0</td></tr> <tr><td>Buses</td><td>0</td></tr> <tr><td>Totals</td><td>1</td></tr> </table>	Cars	1	Trucks	0	Buses	0	Totals	1		<table style="border-collapse: collapse; margin: auto;"> <tr><td>Cars</td><td>0</td><td>0</td><td>0</td><td style="border-left: 1px solid black;">0</td></tr> <tr><td>Trucks</td><td>0</td><td>0</td><td>0</td><td style="border-left: 1px solid black;">0</td></tr> <tr><td>Buses</td><td>0</td><td>0</td><td>0</td><td style="border-left: 1px solid black;">0</td></tr> <tr><td>Totals</td><td>0</td><td>0</td><td>0</td><td style="border-left: 1px solid black;"></td></tr> </table>	Cars	0	0	0	0	Trucks	0	0	0	0	Buses	0	0	0	0	Totals	0	0	0		Peds Cross: ☒ South Peds: 0 South Entering: 0 South Leg Total: 1
Cars	1																															
Trucks	0																															
Buses	0																															
Totals	1																															
Cars	0	0	0	0																												
Trucks	0	0	0	0																												
Buses	0	0	0	0																												
Totals	0	0	0																													
<h3>Comments</h3>																																

Total Count Diagram

Municipality: Windsor
Site #: 2202100002
Intersection: Wyandotte St E & Clover St
TFR File #: 1
Count date: 19-Feb-22

Weather conditions:

Person counted:
Person prepared:
Person checked:

**** Non-Signalized Intersection ****

Major Road: Wyandotte St E runs W/E

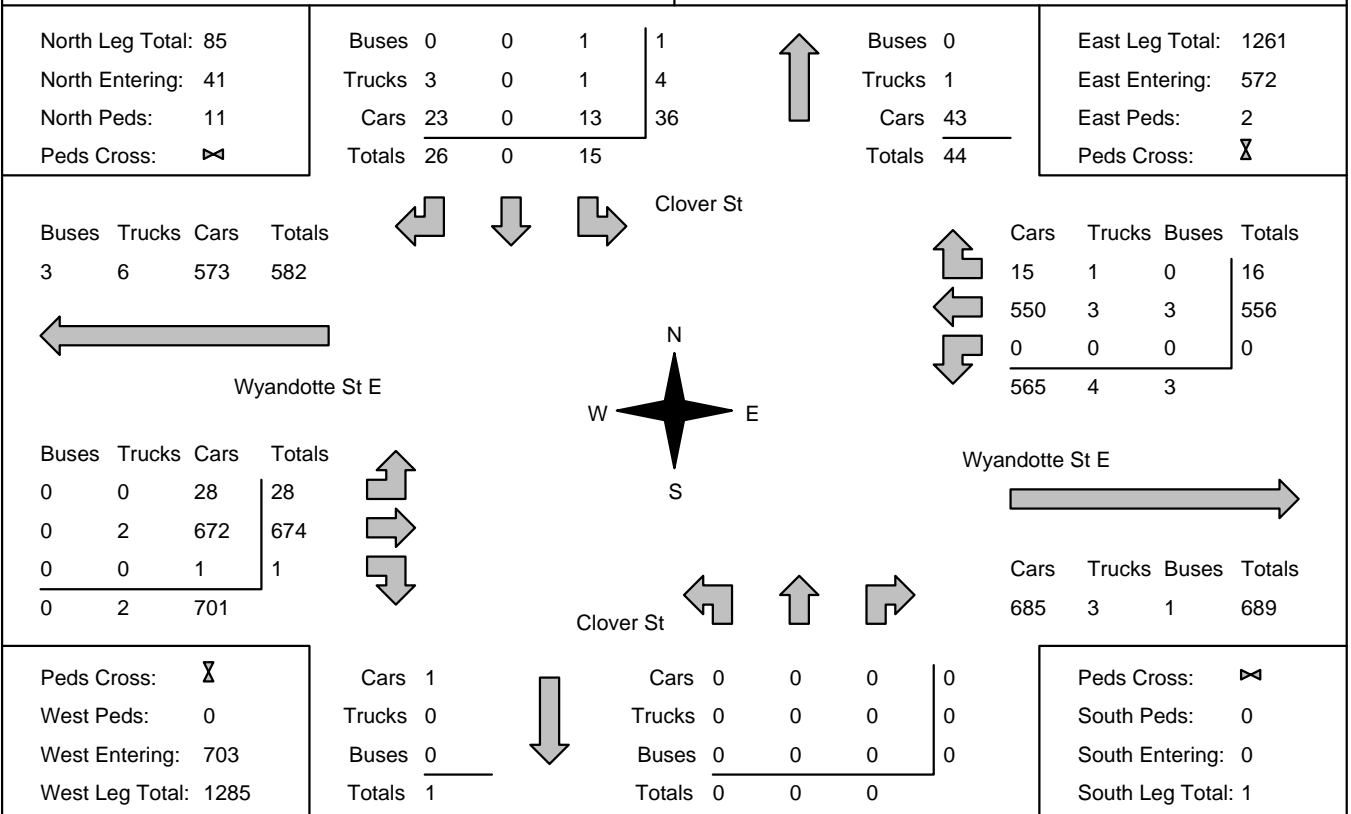

Comments

Traffic Count Summary

Intersection: Wyandotte St E & Clover St Count Date: 19-Feb-22 Municipality: Windsor

North Approach Totals						North/South Total Approaches	South Approach Totals						
Hour Ending	Includes Cars, Trucks, & Buses				Total Peds		Hour Ending	Includes Cars, Trucks, & Buses				Total Peds	
	Left	Thru	Right	Grand Total				Left	Thru	Right	Grand Total		
12:00:00	0	0	0	0	0	0	12:00:00	0	0	0	0	0	
13:00:00	5	0	5	10	6	10	13:00:00	0	0	0	0	0	
14:00:00	5	0	9	14	4	14	14:00:00	0	0	0	0	0	
15:00:00	5	0	12	17	1	17	15:00:00	0	0	0	0	0	
Totals:	15	0	26	41	11	41	S Totals:	0	0	0	0	0	
East Approach Totals						East/West Total Approaches	West Approach Totals						
Hour Ending	Includes Cars, Trucks, & Buses				Total Peds		Hour Ending	Includes Cars, Trucks, & Buses				Total Peds	
	Left	Thru	Right	Grand Total				Left	Thru	Right	Grand Total		
12:00:00	0	0	0	0	0	0	12:00:00	0	0	0	0	0	
13:00:00	0	176	2	178	1	401	13:00:00	12	211	0	223	0	
14:00:00	0	181	7	188	1	417	14:00:00	6	223	0	229	0	
15:00:00	0	199	7	206	0	457	15:00:00	10	240	1	251	0	
Totals:	0	556	16	572	2	1275	W Totals:	28	674	1	703	0	
Calculated Values for Traffic Crossing Major Street													
Hours Ending:	12:00	13:00	14:00	15:00					0:00	0:00	0:00	0:00	
Crossing Values:	0	6	6	5					0	0	0	0	





Count Date: 19-Feb-22 Site #: 2202100002

Interval Time	Passenger Cars - North Approach						Trucks - North Approach						Buses - North Approach						Pedestrians	
	Left		Thru		Right		Left		Thru		Right		Left		Thru		Right		North Cross	
	Cum	Incr	Cum	Incr	Cum	Incr	Cum	Incr	Cum	Incr	Cum	Incr	Cum	Incr	Cum	Incr	Cum	Incr	Cum	Incr
12:00:00	0	0	0	0	0	0	0	0	0	0	0	0	0	0	0	0	0	0	0	0
12:15:00	2	2	0	0	2	2	0	0	0	0	0	0	0	0	0	0	0	0	0	0
12:30:00	2	0	0	0	2	0	0	0	0	0	0	0	0	0	0	0	0	0	1	1
12:45:00	3	1	0	0	4	2	0	0	0	0	0	0	0	0	0	0	0	0	6	5
13:00:00	3	0	0	0	5	1	1	1	0	0	0	0	1	1	0	0	0	0	6	0
13:15:00	5	2	0	0	6	1	1	0	0	0	3	3	1	0	0	0	0	0	7	1
13:30:00	6	1	0	0	10	4	1	0	0	0	3	0	1	0	0	0	0	0	8	1
13:45:00	6	0	0	0	10	0	1	0	0	0	3	0	1	0	0	0	0	0	10	2
14:00:00	8	2	0	0	11	1	1	0	0	0	3	0	1	0	0	0	0	0	10	0
14:15:00	9	1	0	0	13	2	1	0	0	0	3	0	1	0	0	0	0	0	10	0
14:30:00	12	3	0	0	20	7	1	0	0	0	3	0	1	0	0	0	0	0	10	0
14:45:00	13	1	0	0	20	0	1	0	0	0	3	0	1	0	0	0	0	0	11	1
15:00:00	13	0	0	0	23	3	1	0	0	0	3	0	1	0	0	0	0	0	11	0
15:15:00	13	0	0	0	23	0	1	0	0	0	3	0	1	0	0	0	0	0	11	0
15:15:15	13	0	0	0	23	0	1	0	0	0	3	0	1	0	0	0	0	0	11	0

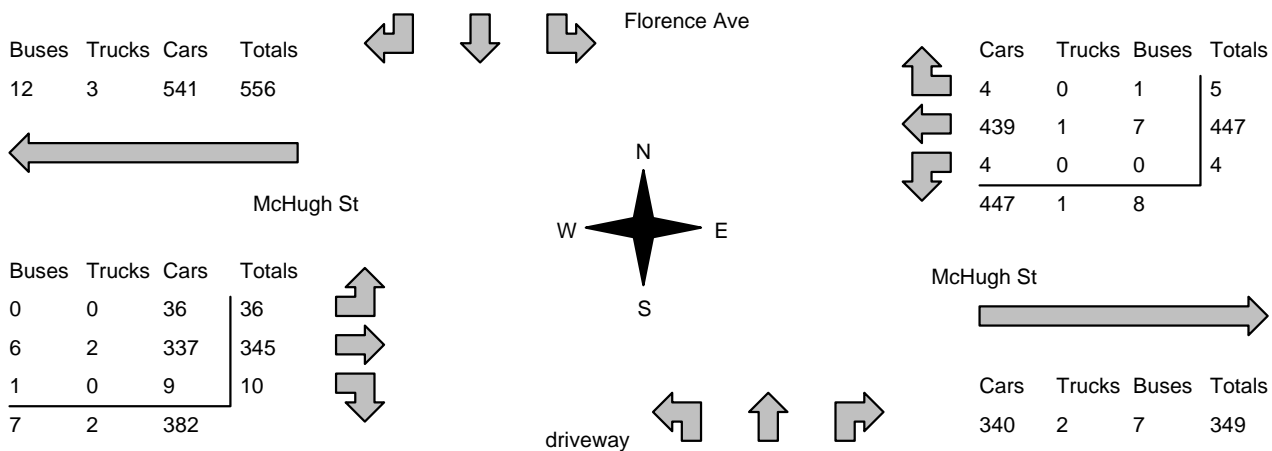

Count Date: 19-Feb-22 Site #: 2202100002

Interval Time	Passenger Cars - East Approach						Trucks - East Approach						Buses - East Approach						Pedestrians	
	Left		Thru		Right		Left		Thru		Right		Left		Thru		Right		East Cross	
	Cum	Incr	Cum	Incr	Cum	Incr	Cum	Incr	Cum	Incr	Cum	Incr	Cum	Incr	Cum	Incr	Cum	Incr	Cum	Incr
12:00:00	0	0	0	0	0	0	0	0	0	0	0	0	0	0	0	0	0	0	0	0
12:15:00	0	0	35	35	0	0	0	0	0	0	0	0	0	0	0	0	0	0	0	0
12:30:00	0	0	74	39	1	1	0	0	0	0	1	1	0	0	1	1	0	0	1	1
12:45:00	0	0	123	49	1	0	0	0	1	1	1	0	0	0	1	0	0	0	1	0
13:00:00	0	0	174	51	1	0	0	0	1	0	1	0	0	0	1	0	0	0	1	0
13:15:00	0	0	227	53	3	2	0	0	2	1	1	0	0	0	1	0	0	0	2	1
13:30:00	0	0	265	38	5	2	0	0	3	1	1	0	0	0	1	0	0	0	2	0
13:45:00	0	0	305	40	7	2	0	0	3	0	1	0	0	0	2	1	0	0	2	0
14:00:00	0	0	352	47	8	1	0	0	3	0	1	0	0	0	2	0	0	0	2	0
14:15:00	0	0	394	42	8	0	0	0	3	0	1	0	0	0	2	0	0	0	2	0
14:30:00	0	0	445	51	11	3	0	0	3	0	1	0	0	0	2	0	0	0	2	0
14:45:00	0	0	488	43	14	3	0	0	3	0	1	0	0	0	2	0	0	0	2	0
15:00:00	0	0	550	62	15	1	0	0	3	0	1	0	0	0	3	1	0	0	2	0
15:15:00	0	0	550	0	15	0	0	0	3	0	1	0	0	0	3	0	0	0	2	0
15:15:15	0	0	550	0	15	0	0	0	3	0	1	0	0	0	3	0	0	0	2	0

<h1>Morning Peak Diagram</h1>	Specified Period From: 7:00:00 To: 10:00:00	One Hour Peak From: 8:00:00 To: 9:00:00																
Municipality: Windsor Site #: 2217900001 Intersection: McHugh St & Florence Ave TFR File #: 1 Count date: 15-Sep-22	Weather conditions: Person counted: Person prepared: Person checked:																	
** Non-Signalized Intersection **	Major Road: McHugh St runs W/E																	
<table style="width:100%; border-collapse: collapse;"> <tr><td style="width:50%;">North Leg Total: 154</td><td style="width:50%;">Buses 5 0 0 5</td></tr> <tr><td>North Entering: 112</td><td>Trucks 2 0 0 2</td></tr> <tr><td>North Peds: 26</td><td>Cars 102 2 1 105</td></tr> <tr><td>Peds Cross: ☒</td><td>Totals 109 2 1</td></tr> </table>	North Leg Total: 154	Buses 5 0 0 5	North Entering: 112	Trucks 2 0 0 2	North Peds: 26	Cars 102 2 1 105	Peds Cross: ☒	Totals 109 2 1		<table style="width:100%; border-collapse: collapse;"> <tr><td style="width:50%;">Buses 1</td><td style="width:50%;">East Leg Total: 805</td></tr> <tr><td>Trucks 0</td><td>East Entering: 456</td></tr> <tr><td>Cars 41</td><td>East Peds: 7</td></tr> <tr><td>Totals 42</td><td>Peds Cross: ☒</td></tr> </table>	Buses 1	East Leg Total: 805	Trucks 0	East Entering: 456	Cars 41	East Peds: 7	Totals 42	Peds Cross: ☒
North Leg Total: 154	Buses 5 0 0 5																	
North Entering: 112	Trucks 2 0 0 2																	
North Peds: 26	Cars 102 2 1 105																	
Peds Cross: ☒	Totals 109 2 1																	
Buses 1	East Leg Total: 805																	
Trucks 0	East Entering: 456																	
Cars 41	East Peds: 7																	
Totals 42	Peds Cross: ☒																	
																		
<table style="width:100%; border-collapse: collapse;"> <tr><td style="width:50%;">Buses 12</td><td style="width:50%;">Cars 4</td></tr> <tr><td>Trucks 3</td><td>Trucks 0</td></tr> <tr><td>Cars 541</td><td>Buses 1</td></tr> <tr><td>Totals 556</td><td>Totals 5</td></tr> </table>	Buses 12	Cars 4	Trucks 3	Trucks 0	Cars 541	Buses 1	Totals 556	Totals 5	<table style="width:100%; border-collapse: collapse;"> <tr><td style="width:50%;">Cars 4</td><td style="width:50%;">Trucks 1</td></tr> <tr><td>Trucks 0</td><td>Buses 7</td></tr> <tr><td>Buses 4</td><td>Totals 447</td></tr> <tr><td>Totals 447</td><td>Totals 4</td></tr> </table>	Cars 4	Trucks 1	Trucks 0	Buses 7	Buses 4	Totals 447	Totals 447	Totals 4	
Buses 12	Cars 4																	
Trucks 3	Trucks 0																	
Cars 541	Buses 1																	
Totals 556	Totals 5																	
Cars 4	Trucks 1																	
Trucks 0	Buses 7																	
Buses 4	Totals 447																	
Totals 447	Totals 4																	
<table style="width:100%; border-collapse: collapse;"> <tr><td style="width:50%;">Buses 0</td><td style="width:50%;">Cars 3</td></tr> <tr><td>Trucks 0</td><td>Trucks 2</td></tr> <tr><td>Cars 36</td><td>Buses 337</td></tr> <tr><td>Totals 36</td><td>Totals 345</td></tr> </table>	Buses 0	Cars 3	Trucks 0	Trucks 2	Cars 36	Buses 337	Totals 36	Totals 345	<table style="width:100%; border-collapse: collapse;"> <tr><td style="width:50%;">Cars 1</td><td style="width:50%;">Trucks 0</td></tr> <tr><td>Trucks 0</td><td>Buses 9</td></tr> <tr><td>Cars 10</td><td>Totals 382</td></tr> <tr><td>Totals 10</td><td>Totals 349</td></tr> </table>	Cars 1	Trucks 0	Trucks 0	Buses 9	Cars 10	Totals 382	Totals 10	Totals 349	
Buses 0	Cars 3																	
Trucks 0	Trucks 2																	
Cars 36	Buses 337																	
Totals 36	Totals 345																	
Cars 1	Trucks 0																	
Trucks 0	Buses 9																	
Cars 10	Totals 382																	
Totals 10	Totals 349																	
<table style="width:100%; border-collapse: collapse;"> <tr><td style="width:50%;">Peds Cross: ☒</td><td style="width:50%;">Cars 15</td></tr> <tr><td>West Peds: 0</td><td>Trucks 0</td></tr> <tr><td>West Entering: 391</td><td>Buses 1</td></tr> <tr><td>West Leg Total: 947</td><td>Totals 16</td></tr> </table>	Peds Cross: ☒	Cars 15	West Peds: 0	Trucks 0	West Entering: 391	Buses 1	West Leg Total: 947	Totals 16		<table style="width:100%; border-collapse: collapse;"> <tr><td style="width:50%;">Cars 0</td><td style="width:50%;">Trucks 1</td></tr> <tr><td>Trucks 0</td><td>Buses 2</td></tr> <tr><td>Buses 0</td><td>Totals 3</td></tr> <tr><td>Totals 0</td><td>Totals 0</td></tr> </table>	Cars 0	Trucks 1	Trucks 0	Buses 2	Buses 0	Totals 3	Totals 0	Totals 0
Peds Cross: ☒	Cars 15																	
West Peds: 0	Trucks 0																	
West Entering: 391	Buses 1																	
West Leg Total: 947	Totals 16																	
Cars 0	Trucks 1																	
Trucks 0	Buses 2																	
Buses 0	Totals 3																	
Totals 0	Totals 0																	
<h2>Comments</h2>																		

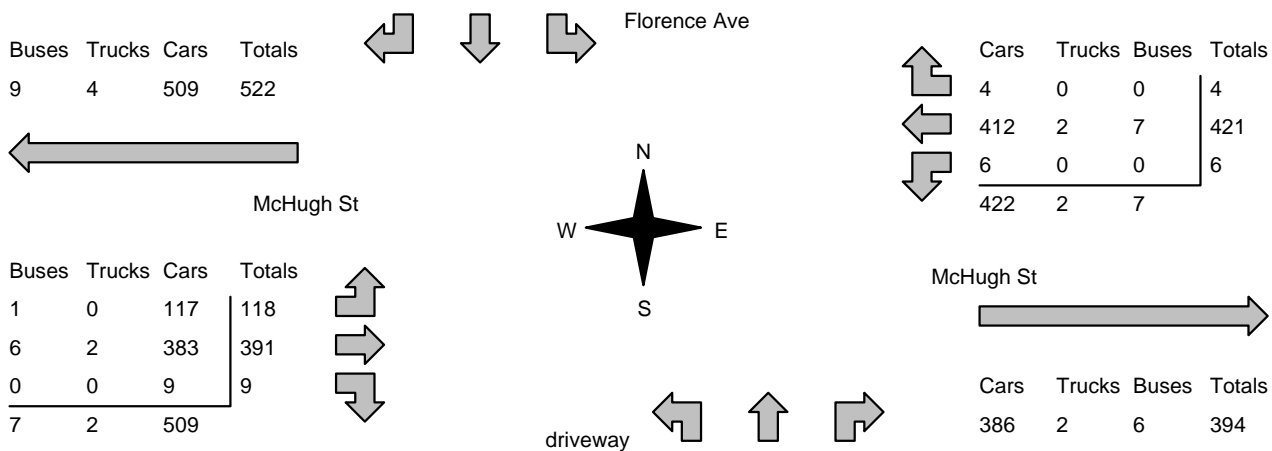
<h2>Afternoon Peak Diagram</h2>	Specified Period From: 15:00:00 To: 18:00:00	One Hour Peak From: 15:00:00 To: 16:00:00																																							
Municipality: Windsor Site #: 2217900001 Intersection: McHugh St & Florence Ave TFR File #: 1 Count date: 15-Sep-22	Weather conditions: Person counted: Person prepared: Person checked:																																								
** Non-Signalized Intersection **	Major Road: McHugh St runs W/E																																								
<table style="width:100%; border-collapse: collapse;"> <tr><td style="width:50%;">North Leg Total: 219</td><td style="width:50%;">Buses 2 0 0 2</td></tr> <tr><td>North Entering: 96</td><td>Trucks 2 0 0 2</td></tr> <tr><td>North Peds: 25</td><td>Cars 90 0 2 92</td></tr> <tr><td>Peds Cross: ☒</td><td>Totals 94 0 2</td></tr> </table>	North Leg Total: 219	Buses 2 0 0 2	North Entering: 96	Trucks 2 0 0 2	North Peds: 25	Cars 90 0 2 92	Peds Cross: ☒	Totals 94 0 2		<table style="width:100%; border-collapse: collapse;"> <tr><td style="width:50%;">Buses 1</td><td style="width:50%;">East Leg Total: 825</td></tr> <tr><td>Trucks 0</td><td>East Entering: 431</td></tr> <tr><td>Cars 122</td><td>East Peds: 4</td></tr> <tr><td>Totals 123</td><td>Peds Cross: ☒</td></tr> </table>	Buses 1	East Leg Total: 825	Trucks 0	East Entering: 431	Cars 122	East Peds: 4	Totals 123	Peds Cross: ☒																							
North Leg Total: 219	Buses 2 0 0 2																																								
North Entering: 96	Trucks 2 0 0 2																																								
North Peds: 25	Cars 90 0 2 92																																								
Peds Cross: ☒	Totals 94 0 2																																								
Buses 1	East Leg Total: 825																																								
Trucks 0	East Entering: 431																																								
Cars 122	East Peds: 4																																								
Totals 123	Peds Cross: ☒																																								
																																									
<table style="width:100%; border-collapse: collapse;"> <tr><th>Buses</th><th>Trucks</th><th>Cars</th><th>Totals</th></tr> <tr><td>9</td><td>4</td><td>509</td><td>522</td></tr> </table>	Buses	Trucks	Cars	Totals	9	4	509	522	<table style="width:100%; border-collapse: collapse;"> <tr><th>Cars</th><th>Trucks</th><th>Buses</th><th>Totals</th></tr> <tr><td>4</td><td>0</td><td>0</td><td>4</td></tr> <tr><td>412</td><td>2</td><td>7</td><td>421</td></tr> <tr><td>6</td><td>0</td><td>0</td><td>6</td></tr> <tr><td>422</td><td>2</td><td>7</td><td></td></tr> </table>	Cars	Trucks	Buses	Totals	4	0	0	4	412	2	7	421	6	0	0	6	422	2	7													
Buses	Trucks	Cars	Totals																																						
9	4	509	522																																						
Cars	Trucks	Buses	Totals																																						
4	0	0	4																																						
412	2	7	421																																						
6	0	0	6																																						
422	2	7																																							
<table style="width:100%; border-collapse: collapse;"> <tr><th>Buses</th><th>Trucks</th><th>Cars</th><th>Totals</th></tr> <tr><td>1</td><td>0</td><td>117</td><td>118</td></tr> <tr><td>6</td><td>2</td><td>383</td><td>391</td></tr> <tr><td>0</td><td>0</td><td>9</td><td>9</td></tr> <tr><td>7</td><td>2</td><td>509</td><td></td></tr> </table>	Buses	Trucks	Cars	Totals	1	0	117	118	6	2	383	391	0	0	9	9	7	2	509		<table style="width:100%; border-collapse: collapse;"> <tr><th>Cars</th><th>Trucks</th><th>Buses</th><th>Totals</th></tr> <tr><td>7</td><td>1</td><td>1</td><td>9</td></tr> <tr><td>0</td><td>0</td><td>0</td><td>0</td></tr> <tr><td>0</td><td>0</td><td>0</td><td>0</td></tr> <tr><td>7</td><td>1</td><td>1</td><td></td></tr> </table>	Cars	Trucks	Buses	Totals	7	1	1	9	0	0	0	0	0	0	0	0	7	1	1	
Buses	Trucks	Cars	Totals																																						
1	0	117	118																																						
6	2	383	391																																						
0	0	9	9																																						
7	2	509																																							
Cars	Trucks	Buses	Totals																																						
7	1	1	9																																						
0	0	0	0																																						
0	0	0	0																																						
7	1	1																																							
<table style="width:100%; border-collapse: collapse;"> <tr><td style="width:50%;">Peds Cross: ☒</td><td style="width:50%;">Cars 15</td></tr> <tr><td>West Peds: 2</td><td>Trucks 0</td></tr> <tr><td>West Entering: 518</td><td>Buses 0</td></tr> <tr><td>West Leg Total: 1040</td><td>Totals 15</td></tr> </table>	Peds Cross: ☒	Cars 15	West Peds: 2	Trucks 0	West Entering: 518	Buses 0	West Leg Total: 1040	Totals 15	<table style="width:100%; border-collapse: collapse;"> <tr><td style="width:50%;">Cars 7</td><td style="width:50%;">Cars 7</td></tr> <tr><td>Trucks 0</td><td>Trucks 0</td></tr> <tr><td>Buses 0</td><td>Buses 0</td></tr> <tr><td>Totals 7</td><td>Totals 7</td></tr> </table>	Cars 7	Cars 7	Trucks 0	Trucks 0	Buses 0	Buses 0	Totals 7	Totals 7	<table style="width:100%; border-collapse: collapse;"> <tr><td style="width:50%;">Peds Cross: ☒</td><td style="width:50%;">Peds Cross: ☒</td></tr> <tr><td>South Peds: 2</td><td>South Peds: 2</td></tr> <tr><td>South Entering: 9</td><td>South Entering: 9</td></tr> <tr><td>South Leg Total: 24</td><td>South Leg Total: 24</td></tr> </table>	Peds Cross: ☒	Peds Cross: ☒	South Peds: 2	South Peds: 2	South Entering: 9	South Entering: 9	South Leg Total: 24	South Leg Total: 24															
Peds Cross: ☒	Cars 15																																								
West Peds: 2	Trucks 0																																								
West Entering: 518	Buses 0																																								
West Leg Total: 1040	Totals 15																																								
Cars 7	Cars 7																																								
Trucks 0	Trucks 0																																								
Buses 0	Buses 0																																								
Totals 7	Totals 7																																								
Peds Cross: ☒	Peds Cross: ☒																																								
South Peds: 2	South Peds: 2																																								
South Entering: 9	South Entering: 9																																								
South Leg Total: 24	South Leg Total: 24																																								
<h3>Comments</h3>																																									

Total Count Diagram

Municipality: Windsor
Site #: 2217900001
Intersection: McHugh St & Florence Ave
TFR File #: 1
Count date: 15-Sep-22

Weather conditions:

Person counted:
Person prepared:
Person checked:

**** Non-Signalized Intersection ****

Major Road: McHugh St runs W/E

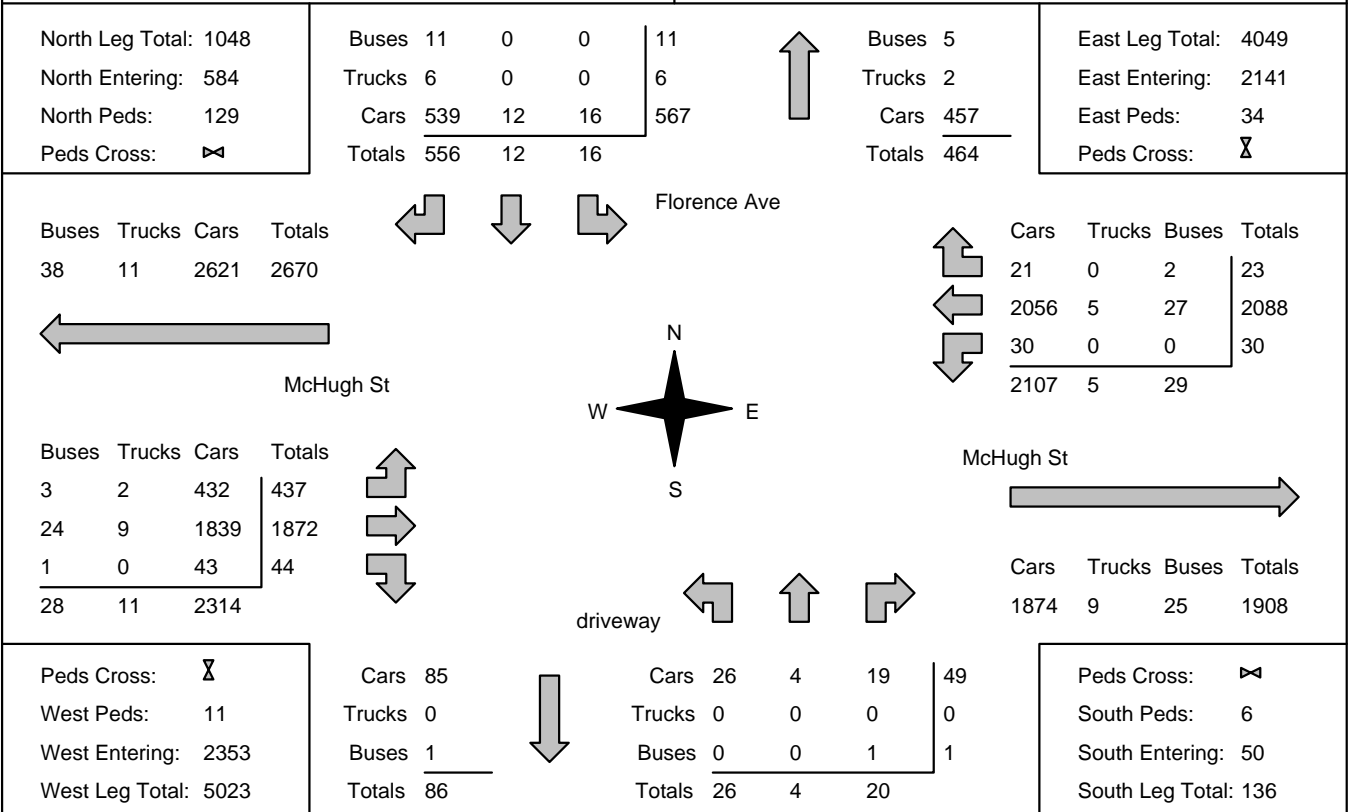

Comments

Traffic Count Summary



Intersection: McHugh St & Florence Ave Count Date: 15-Sep-22 Municipality: Windsor

North Approach Totals						North/South Total Approaches	South Approach Totals					
Hour Ending	Includes Cars, Trucks, & Buses				Total Peds		Hour Ending	Includes Cars, Trucks, & Buses				Total Peds
	Left	Thru	Right	Grand Total				Left	Thru	Right	Grand Total	
7:00:00	0	0	0	0	0	0	7:00:00	0	0	0	0	0
8:00:00	1	0	95	96	14	98	8:00:00	1	0	1	2	0
9:00:00	1	2	109	112	26	116	9:00:00	0	1	3	4	2
10:00:00	3	6	94	103	28	112	10:00:00	5	1	3	9	0
15:00:00	0	0	0	0	0	0	15:00:00	0	0	0	0	0
16:00:00	2	0	94	96	25	105	16:00:00	7	1	1	9	2
17:00:00	5	1	88	94	18	104	17:00:00	4	0	6	10	2
18:00:00	4	3	76	83	18	99	18:00:00	9	1	6	16	0
Totals:	16	12	556	584	129	634	S Totals:	26	4	20	50	6
East Approach Totals						East/West Total Approaches	West Approach Totals					
Hour Ending	Includes Cars, Trucks, & Buses				Total Peds		Hour Ending	Includes Cars, Trucks, & Buses				Total Peds
	Left	Thru	Right	Grand Total				Left	Thru	Right	Grand Total	
7:00:00	0	0	0	0	0	0	7:00:00	0	0	0	0	0
8:00:00	5	321	1	327	3	502	8:00:00	17	155	3	175	0
9:00:00	4	447	5	456	7	847	9:00:00	36	345	10	391	0
10:00:00	5	291	3	299	5	557	10:00:00	44	209	5	258	3
15:00:00	0	0	0	0	0	0	15:00:00	0	0	0	0	0
16:00:00	6	421	4	431	4	949	16:00:00	118	391	9	518	2
17:00:00	5	294	3	302	13	830	17:00:00	120	402	6	528	2
18:00:00	5	314	7	326	2	808	18:00:00	102	370	10	482	4
Totals:	30	2088	23	2141	34	4493	W Totals:	437	1872	43	2352	11
Calculated Values for Traffic Crossing Major Street												
Hours Ending:	7:00	8:00	9:00	10:00			15:00	16:00	17:00	18:00		
Crossing Values:	0	5	10	22			0	16	25	22		

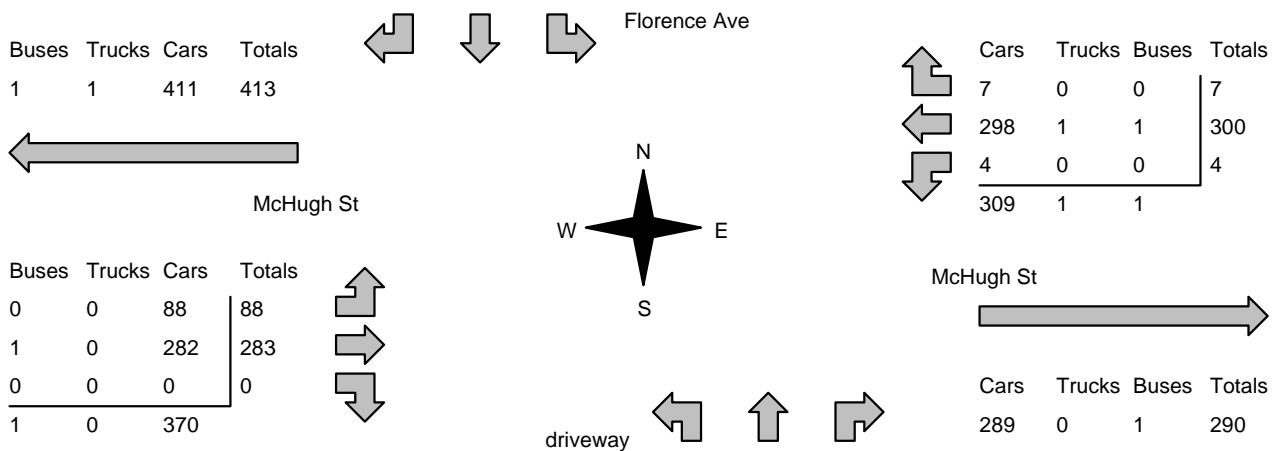

Count Date: 15-Sep-22 Site #: 2217900001

Interval Time	Passenger Cars - North Approach						Trucks - North Approach						Buses - North Approach						Pedestrians	
	Left		Thru		Right		Left		Thru		Right		Left		Thru		Right		North Cross	
	Cum	Incr	Cum	Incr	Cum	Incr	Cum	Incr	Cum	Incr	Cum	Incr	Cum	Incr	Cum	Incr	Cum	Incr	Cum	Incr
7:00:00	0	0	0	0	0	0	0	0	0	0	0	0	0	0	0	0	0	0	0	0
7:15:00	0	0	0	0	12	12	0	0	0	0	0	0	0	0	0	0	0	0	1	1
7:30:00	0	0	0	0	21	9	0	0	0	0	0	0	0	0	0	0	0	0	7	6
7:45:00	0	0	0	0	58	37	0	0	0	0	0	0	0	0	0	0	1	1	10	3
8:00:00	1	1	0	0	92	34	0	0	0	0	0	0	0	0	0	0	3	2	14	4
8:15:00	1	0	1	1	114	22	0	0	0	0	0	0	0	0	0	3	0	19	5	
8:30:00	2	1	2	1	140	26	0	0	0	0	1	1	0	0	0	0	3	0	24	5
8:45:00	2	0	2	0	163	23	0	0	0	0	1	0	0	0	0	0	5	2	30	6
9:00:00	2	0	2	0	194	31	0	0	0	0	2	1	0	0	0	0	8	3	40	10
9:15:00	2	0	3	1	216	22	0	0	0	0	2	0	0	0	0	0	8	0	47	7
9:30:00	4	2	5	2	242	26	0	0	0	0	2	0	0	0	0	0	8	0	59	12
9:45:00	4	0	7	2	267	25	0	0	0	0	2	0	0	0	0	0	8	0	66	7
10:00:00	5	1	8	1	288	21	0	0	0	0	2	0	0	0	0	0	8	0	68	2
10:15:00	5	0	8	0	288	0	0	0	0	0	2	0	0	0	0	0	8	0	68	0
15:00:00	5	0	8	0	288	0	0	0	0	0	2	0	0	0	0	0	8	0	68	0
15:15:00	7	2	8	0	321	33	0	0	0	0	2	0	0	0	0	0	9	1	76	8
15:30:00	7	0	8	0	344	23	0	0	0	0	2	0	0	0	0	0	9	0	82	6
15:45:00	7	0	8	0	357	13	0	0	0	0	2	0	0	0	0	0	9	0	87	5
16:00:00	7	0	8	0	378	21	0	0	0	0	4	2	0	0	0	0	10	1	93	6
16:15:00	8	1	8	0	396	18	0	0	0	0	5	1	0	0	0	0	11	1	101	8
16:30:00	8	0	8	0	420	24	0	0	0	0	5	0	0	0	0	0	11	0	104	3
16:45:00	10	2	8	0	442	22	0	0	0	0	6	1	0	0	0	0	11	0	108	4
17:00:00	12	2	9	1	463	21	0	0	0	0	6	0	0	0	0	0	11	0	111	3
17:15:00	13	1	10	1	481	18	0	0	0	0	6	0	0	0	0	0	11	0	117	6
17:30:00	15	2	11	1	500	19	0	0	0	0	6	0	0	0	0	0	11	0	118	1
17:45:00	15	0	11	0	522	22	0	0	0	0	6	0	0	0	0	0	11	0	125	7
18:00:00	16	1	12	1	539	17	0	0	0	0	6	0	0	0	0	0	11	0	129	4
18:15:00	16	0	12	0	539	0	0	0	0	0	6	0	0	0	0	0	11	0	129	0
18:15:15	16	0	12	0	539	0	0	0	0	0	6	0	0	0	0	0	11	0	129	0

<h2>Mid-day Peak Diagram</h2>	Specified Period From: 12:00:00 To: 15:00:00	One Hour Peak From: 12:45:00 To: 13:45:00																																																									
Municipality: Windsor Site #: 2217900001 Intersection: McHugh St & Florence Ave TFR File #: 1 Count date: 17-Sep-22	Weather conditions: Person counted: Person prepared: Person checked:																																																										
** Non-Signalized Intersection **	Major Road: McHugh St runs W/E																																																										
North Leg Total: 205 North Entering: 110 North Peds: 22 Peds Cross: \boxtimes	<table style="border-collapse: collapse; margin: auto;"> <tr><td>Buses</td><td>0</td><td>0</td><td>0</td><td>0</td></tr> <tr><td>Trucks</td><td>0</td><td>0</td><td>0</td><td>0</td></tr> <tr><td>Cars</td><td>104</td><td>2</td><td>4</td><td>110</td></tr> <tr style="border-top: 1px solid black;"><td>Totals</td><td>104</td><td>2</td><td>4</td><td></td></tr> </table>	Buses	0	0	0	0	Trucks	0	0	0	0	Cars	104	2	4	110	Totals	104	2	4		 <table style="border-collapse: collapse; margin: auto;"> <tr><td>Buses</td><td>0</td></tr> <tr><td>Trucks</td><td>0</td></tr> <tr><td>Cars</td><td>95</td></tr> <tr style="border-top: 1px solid black;"><td>Totals</td><td>95</td></tr> </table>	Buses	0	Trucks	0	Cars	95	Totals	95	East Leg Total: 601 East Entering: 311 East Peds: 7 Peds Cross: \boxtimes																												
Buses	0	0	0	0																																																							
Trucks	0	0	0	0																																																							
Cars	104	2	4	110																																																							
Totals	104	2	4																																																								
Buses	0																																																										
Trucks	0																																																										
Cars	95																																																										
Totals	95																																																										
																																																											
<table style="border-collapse: collapse;"> <tr><td>Buses</td><td>Trucks</td><td>Cars</td><td>Totals</td></tr> <tr><td>1</td><td>1</td><td>411</td><td>413</td></tr> </table>	Buses	Trucks	Cars	Totals	1	1	411	413	<table style="border-collapse: collapse;"> <tr><td>Cars</td><td>Trucks</td><td>Buses</td><td>Totals</td></tr> <tr><td>7</td><td>0</td><td>0</td><td>7</td></tr> <tr><td>298</td><td>1</td><td>1</td><td>300</td></tr> <tr><td>4</td><td>0</td><td>0</td><td>4</td></tr> <tr style="border-top: 1px solid black;"><td>309</td><td>1</td><td>1</td><td></td></tr> </table>	Cars	Trucks	Buses	Totals	7	0	0	7	298	1	1	300	4	0	0	4	309	1	1		<table style="border-collapse: collapse;"> <tr><td>Buses</td><td>Trucks</td><td>Cars</td><td>Totals</td></tr> <tr><td>0</td><td>0</td><td>88</td><td>88</td></tr> <tr><td>1</td><td>0</td><td>282</td><td>283</td></tr> <tr><td>0</td><td>0</td><td>0</td><td>0</td></tr> <tr style="border-top: 1px solid black;"><td>1</td><td>0</td><td>370</td><td></td></tr> </table>	Buses	Trucks	Cars	Totals	0	0	88	88	1	0	282	283	0	0	0	0	1	0	370		<table style="border-collapse: collapse;"> <tr><td>Cars</td><td>Trucks</td><td>Buses</td><td>Totals</td></tr> <tr><td>289</td><td>0</td><td>1</td><td>290</td></tr> </table>	Cars	Trucks	Buses	Totals	289	0	1	290
Buses	Trucks	Cars	Totals																																																								
1	1	411	413																																																								
Cars	Trucks	Buses	Totals																																																								
7	0	0	7																																																								
298	1	1	300																																																								
4	0	0	4																																																								
309	1	1																																																									
Buses	Trucks	Cars	Totals																																																								
0	0	88	88																																																								
1	0	282	283																																																								
0	0	0	0																																																								
1	0	370																																																									
Cars	Trucks	Buses	Totals																																																								
289	0	1	290																																																								
Peds Cross: \boxtimes West Peds: 2 West Entering: 371 West Leg Total: 784	 <table style="border-collapse: collapse; margin: auto;"> <tr><td>Cars</td><td>6</td><td>Cars</td><td>9</td><td>0</td><td>3</td><td>12</td></tr> <tr><td>Trucks</td><td>0</td><td>Trucks</td><td>0</td><td>0</td><td>0</td><td>0</td></tr> <tr><td>Buses</td><td>0</td><td>Buses</td><td>0</td><td>0</td><td>0</td><td>0</td></tr> <tr style="border-top: 1px solid black;"><td>Totals</td><td>6</td><td>Totals</td><td>9</td><td>0</td><td>3</td><td></td></tr> </table>	Cars	6	Cars	9	0	3	12	Trucks	0	Trucks	0	0	0	0	Buses	0	Buses	0	0	0	0	Totals	6	Totals	9	0	3		Peds Cross: \boxtimes South Peds: 0 South Entering: 12 South Leg Total: 18																													
Cars	6	Cars	9	0	3	12																																																					
Trucks	0	Trucks	0	0	0	0																																																					
Buses	0	Buses	0	0	0	0																																																					
Totals	6	Totals	9	0	3																																																						
<h3>Comments</h3>																																																											

Total Count Diagram

Municipality: Windsor
Site #: 2217900001
Intersection: McHugh St & Florence Ave
TFR File #: 1
Count date: 17-Sep-22

Weather conditions:

Person counted:
Person prepared:
Person checked:

**** Non-Signalized Intersection ****

Major Road: McHugh St runs W/E

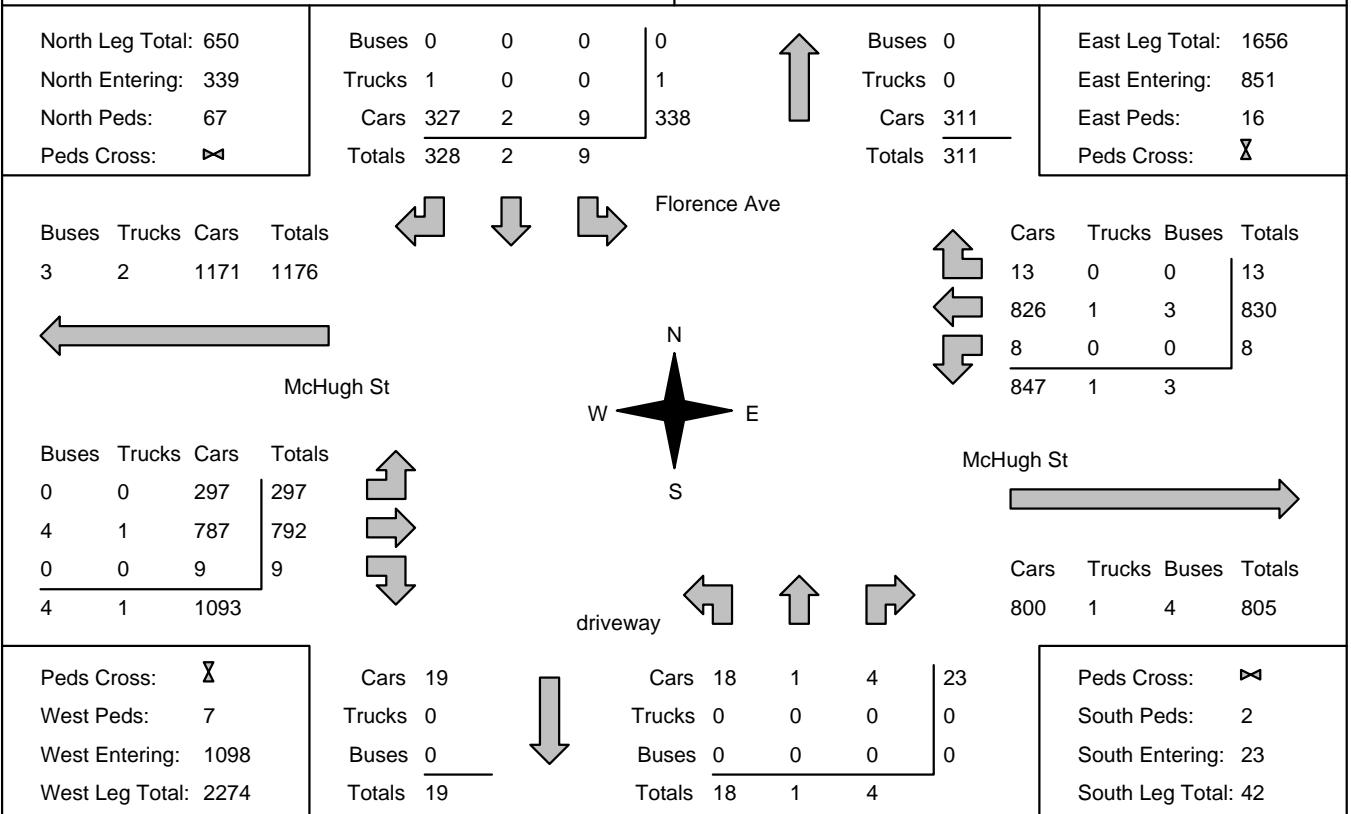





Comments

Traffic Count Summary

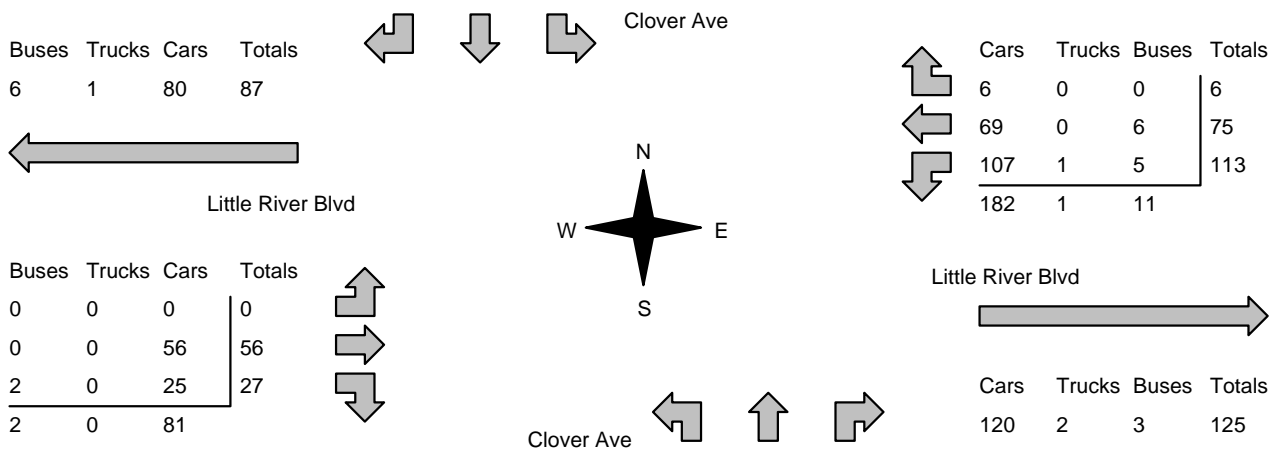
Intersection: McHugh St & Florence Ave Count Date: 17-Sep-22 Municipality: Windsor

North Approach Totals						North/South Total Approaches	South Approach Totals					
Hour Ending	Includes Cars, Trucks, & Buses				Total Peds		Hour Ending	Includes Cars, Trucks, & Buses				Total Peds
	Left	Thru	Right	Grand Total				Left	Thru	Right	Grand Total	
12:00:00	0	0	0	0	0	0	12:00:00	0	0	0	0	0
13:00:00	5	1	121	127	32	132	13:00:00	5	0	0	5	2
14:00:00	3	1	101	105	20	117	14:00:00	8	1	3	12	0
15:00:00	1	0	106	107	15	113	15:00:00	5	0	1	6	0
Totals:	9	2	328	339	67	362	S Totals:	18	1	4	23	2
East Approach Totals						East/West Total Approaches	West Approach Totals					
Hour Ending	Includes Cars, Trucks, & Buses				Total Peds		Hour Ending	Includes Cars, Trucks, & Buses				Total Peds
	Left	Thru	Right	Grand Total				Left	Thru	Right	Grand Total	
12:00:00	0	0	0	0	0	0	12:00:00	0	0	0	0	0
13:00:00	3	291	3	297	2	661	13:00:00	122	237	5	364	2
14:00:00	4	279	7	290	9	674	14:00:00	85	298	1	384	2
15:00:00	1	260	3	264	5	614	15:00:00	90	257	3	350	3
Totals:	8	830	13	851	16	1949	W Totals:	297	792	9	1098	7
Calculated Values for Traffic Crossing Major Street												
Hours Ending:	12:00	13:00	14:00	15:00					0:00	0:00	0:00	0:00
Crossing Values:	0	15	23	14					0	0	0	0

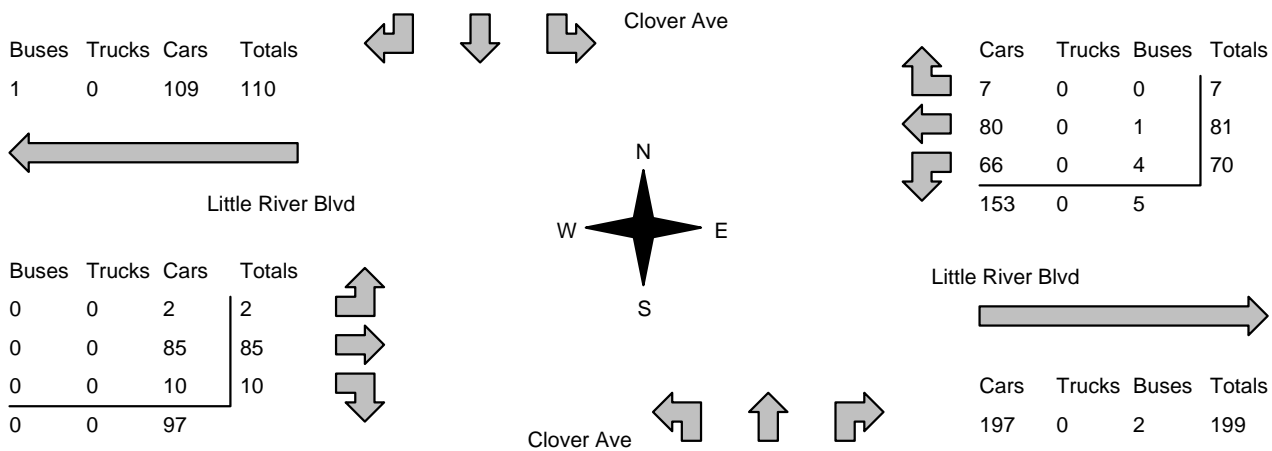
Morning Peak Diagram		Specified Period From: 7:00:00 To: 10:00:00	One Hour Peak From: 8:15:00 To: 9:15:00																													
Municipality: Windsor Site #: 2217900002 Intersection: Little River Blvd & Clover Ave TFR File #: 1 Count date: 15-Sep-22		Weather conditions: Person counted: Person prepared: Person checked:																														
** Non-Signalized Intersection **		Major Road: Little River Blvd runs W/E																														
North Leg Total: 41 North Entering: 28 North Peds: 20 Peds Cross: ☒	<table style="border-collapse: collapse;"> <tr><td>Buses</td><td>0</td><td>0</td><td>0</td><td>0</td></tr> <tr><td>Trucks</td><td>0</td><td>1</td><td>0</td><td>1</td></tr> <tr><td>Cars</td><td>4</td><td>11</td><td>12</td><td>27</td></tr> <tr><td>Totals</td><td>4</td><td>12</td><td>12</td><td></td></tr> </table>	Buses	0	0	0	0	Trucks	0	1	0	1	Cars	4	11	12	27	Totals	4	12	12			<table style="border-collapse: collapse;"> <tr><td>Buses</td><td>0</td></tr> <tr><td>Trucks</td><td>0</td></tr> <tr><td>Cars</td><td>13</td></tr> <tr><td>Totals</td><td>13</td></tr> </table>	Buses	0	Trucks	0	Cars	13	Totals	13	East Leg Total: 319 East Entering: 194 East Peds: 4 Peds Cross: ☒
Buses	0	0	0	0																												
Trucks	0	1	0	1																												
Cars	4	11	12	27																												
Totals	4	12	12																													
Buses	0																															
Trucks	0																															
Cars	13																															
Totals	13																															
																																
<table style="border-collapse: collapse;"> <tr><td>Buses</td><td>Trucks</td><td>Cars</td><td>Totals</td></tr> <tr><td>6</td><td>1</td><td>80</td><td>87</td></tr> </table>	Buses	Trucks	Cars	Totals	6	1	80	87			<table style="border-collapse: collapse;"> <tr><td>Cars</td><td>Trucks</td><td>Buses</td><td>Totals</td></tr> <tr><td>6</td><td>0</td><td>0</td><td>6</td></tr> <tr><td>69</td><td>0</td><td>6</td><td>75</td></tr> <tr><td>107</td><td>1</td><td>5</td><td>113</td></tr> <tr><td>182</td><td>1</td><td>11</td><td></td></tr> </table>	Cars	Trucks	Buses	Totals	6	0	0	6	69	0	6	75	107	1	5	113	182	1	11		
Buses	Trucks	Cars	Totals																													
6	1	80	87																													
Cars	Trucks	Buses	Totals																													
6	0	0	6																													
69	0	6	75																													
107	1	5	113																													
182	1	11																														
<table style="border-collapse: collapse;"> <tr><td>Buses</td><td>Trucks</td><td>Cars</td><td>Totals</td></tr> <tr><td>0</td><td>0</td><td>0</td><td>0</td></tr> <tr><td>0</td><td>0</td><td>56</td><td>56</td></tr> <tr><td>2</td><td>0</td><td>25</td><td>27</td></tr> <tr><td>2</td><td>0</td><td>81</td><td></td></tr> </table>	Buses	Trucks	Cars	Totals	0	0	0	0	0	0	56	56	2	0	25	27	2	0	81				<table style="border-collapse: collapse;"> <tr><td>Cars</td><td>Trucks</td><td>Buses</td><td>Totals</td></tr> <tr><td>120</td><td>2</td><td>3</td><td>125</td></tr> </table>	Cars	Trucks	Buses	Totals	120	2	3	125	
Buses	Trucks	Cars	Totals																													
0	0	0	0																													
0	0	56	56																													
2	0	25	27																													
2	0	81																														
Cars	Trucks	Buses	Totals																													
120	2	3	125																													
Peds Cross: ☒ West Peds: 9 West Entering: 83 West Leg Total: 170	<table style="border-collapse: collapse;"> <tr><td>Cars</td><td>143</td></tr> <tr><td>Trucks</td><td>2</td></tr> <tr><td>Buses</td><td>7</td></tr> <tr><td>Totals</td><td>152</td></tr> </table>	Cars	143	Trucks	2	Buses	7	Totals	152		<table style="border-collapse: collapse;"> <tr><td>Cars</td><td>7</td><td>7</td><td>52</td><td>66</td></tr> <tr><td>Trucks</td><td>1</td><td>0</td><td>2</td><td>3</td></tr> <tr><td>Buses</td><td>0</td><td>0</td><td>3</td><td>3</td></tr> <tr><td>Totals</td><td>8</td><td>7</td><td>57</td><td></td></tr> </table>	Cars	7	7	52	66	Trucks	1	0	2	3	Buses	0	0	3	3	Totals	8	7	57		Peds Cross: ☒ South Peds: 22 South Entering: 72 South Leg Total: 224
Cars	143																															
Trucks	2																															
Buses	7																															
Totals	152																															
Cars	7	7	52	66																												
Trucks	1	0	2	3																												
Buses	0	0	3	3																												
Totals	8	7	57																													
Comments																																

Afternoon Peak Diagram		Specified Period From: 15:00:00 To: 18:00:00	One Hour Peak From: 15:00:00 To: 16:00:00																													
Municipality: Windsor Site #: 2217900002 Intersection: Little River Blvd & Clover Ave TFR File #: 1 Count date: 15-Sep-22		Weather conditions: Person counted: Person prepared: Person checked:																														
** Non-Signalized Intersection **		Major Road: Little River Blvd runs W/E																														
North Leg Total: 46 North Entering: 27 North Peds: 18 Peds Cross: ☒	<table style="border-collapse: collapse;"> <tr><td>Buses</td><td>0</td><td>0</td><td>0</td><td>0</td></tr> <tr><td>Trucks</td><td>0</td><td>0</td><td>0</td><td>0</td></tr> <tr><td>Cars</td><td>4</td><td>7</td><td>16</td><td>27</td></tr> <tr style="border-top: 1px solid black;"><td>Totals</td><td>4</td><td>7</td><td>16</td><td></td></tr> </table>	Buses	0	0	0	0	Trucks	0	0	0	0	Cars	4	7	16	27	Totals	4	7	16			<table style="border-collapse: collapse;"> <tr><td>Buses</td><td>0</td></tr> <tr><td>Trucks</td><td>0</td></tr> <tr><td>Cars</td><td>19</td></tr> <tr style="border-top: 1px solid black;"><td>Totals</td><td>19</td></tr> </table>	Buses	0	Trucks	0	Cars	19	Totals	19	East Leg Total: 357 East Entering: 158 East Peds: 8 Peds Cross: ☒
Buses	0	0	0	0																												
Trucks	0	0	0	0																												
Cars	4	7	16	27																												
Totals	4	7	16																													
Buses	0																															
Trucks	0																															
Cars	19																															
Totals	19																															
																																
<table style="border-collapse: collapse;"> <tr><td>Buses</td><td>Trucks</td><td>Cars</td><td>Totals</td></tr> <tr><td>1</td><td>0</td><td>109</td><td>110</td></tr> </table>	Buses	Trucks	Cars	Totals	1	0	109	110			<table style="border-collapse: collapse;"> <tr><td>Cars</td><td>Trucks</td><td>Buses</td><td>Totals</td></tr> <tr><td>7</td><td>0</td><td>0</td><td>7</td></tr> <tr><td>80</td><td>0</td><td>1</td><td>81</td></tr> <tr><td>66</td><td>0</td><td>4</td><td>70</td></tr> <tr style="border-top: 1px solid black;"><td>153</td><td>0</td><td>5</td><td></td></tr> </table>	Cars	Trucks	Buses	Totals	7	0	0	7	80	0	1	81	66	0	4	70	153	0	5		
Buses	Trucks	Cars	Totals																													
1	0	109	110																													
Cars	Trucks	Buses	Totals																													
7	0	0	7																													
80	0	1	81																													
66	0	4	70																													
153	0	5																														
<table style="border-collapse: collapse;"> <tr><td>Buses</td><td>Trucks</td><td>Cars</td><td>Totals</td></tr> <tr><td>0</td><td>0</td><td>2</td><td>2</td></tr> <tr><td>0</td><td>0</td><td>85</td><td>85</td></tr> <tr><td>0</td><td>0</td><td>10</td><td>10</td></tr> <tr style="border-top: 1px solid black;"><td>0</td><td>0</td><td>97</td><td></td></tr> </table>	Buses	Trucks	Cars	Totals	0	0	2	2	0	0	85	85	0	0	10	10	0	0	97					<table style="border-collapse: collapse;"> <tr><td>Cars</td><td>Trucks</td><td>Buses</td><td>Totals</td></tr> <tr><td>197</td><td>0</td><td>2</td><td>199</td></tr> </table>	Cars	Trucks	Buses	Totals	197	0	2	199
Buses	Trucks	Cars	Totals																													
0	0	2	2																													
0	0	85	85																													
0	0	10	10																													
0	0	97																														
Cars	Trucks	Buses	Totals																													
197	0	2	199																													
Peds Cross: ☒ West Peds: 8 West Entering: 97 West Leg Total: 207	<table style="border-collapse: collapse;"> <tr><td>Cars</td><td>83</td></tr> <tr><td>Trucks</td><td>0</td></tr> <tr><td>Buses</td><td>4</td></tr> <tr style="border-top: 1px solid black;"><td>Totals</td><td>87</td></tr> </table>	Cars	83	Trucks	0	Buses	4	Totals	87		<table style="border-collapse: collapse;"> <tr><td>Cars</td><td>25</td><td>10</td><td>96</td><td>131</td></tr> <tr><td>Trucks</td><td>0</td><td>0</td><td>0</td><td>0</td></tr> <tr><td>Buses</td><td>0</td><td>0</td><td>2</td><td>2</td></tr> <tr style="border-top: 1px solid black;"><td>Totals</td><td>25</td><td>10</td><td>98</td><td></td></tr> </table>	Cars	25	10	96	131	Trucks	0	0	0	0	Buses	0	0	2	2	Totals	25	10	98		Peds Cross: ☒ South Peds: 20 South Entering: 133 South Leg Total: 220
Cars	83																															
Trucks	0																															
Buses	4																															
Totals	87																															
Cars	25	10	96	131																												
Trucks	0	0	0	0																												
Buses	0	0	2	2																												
Totals	25	10	98																													
Comments																																

Total Count Diagram

Municipality: Windsor
Site #: 2217900002
Intersection: Little River Blvd & Clover Ave
TFR File #: 1
Count date: 15-Sep-22

Weather conditions:

Person counted:
Person prepared:
Person checked:

**** Non-Signalized Intersection ****

Major Road: Little River Blvd runs W/E

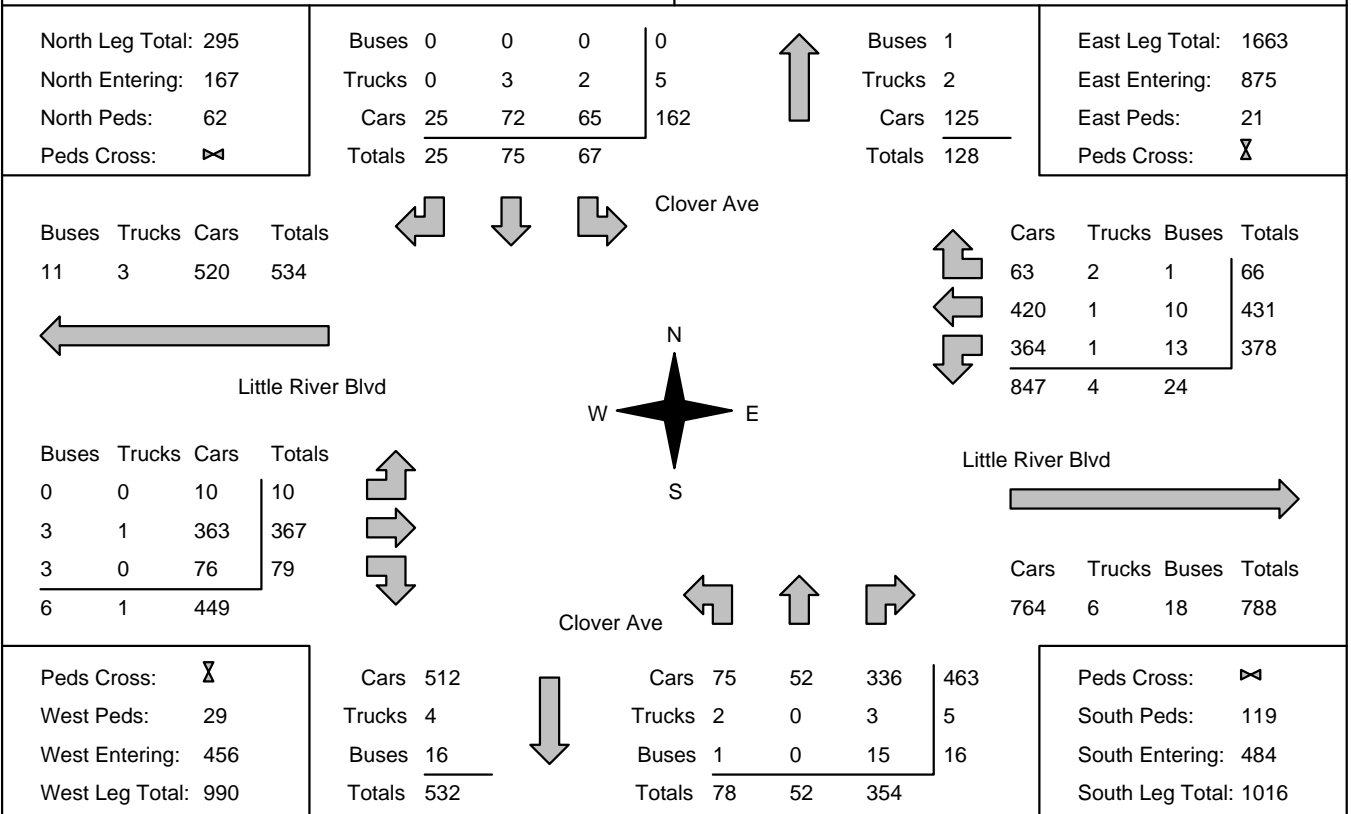

Comments









Traffic Count Summary

Intersection: Little River Blvd & Clover Ave

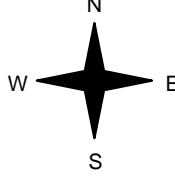
Count Date: 15-Sep-22

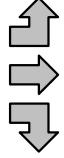
Municipality: Windsor

North Approach Totals						North/South Total Approaches	South Approach Totals					
Hour Ending	Includes Cars, Trucks, & Buses				Total Peds		Hour Ending	Includes Cars, Trucks, & Buses				Total Peds
	Left	Thru	Right	Grand Total				Left	Thru	Right	Grand Total	
7:00:00	0	0	0	0	0	0	7:00:00	0	0	0	0	0
8:00:00	12	14	4	30	12	58	8:00:00	4	2	22	28	18
9:00:00	17	18	5	40	21	112	9:00:00	9	7	56	72	30
10:00:00	5	9	5	19	2	71	10:00:00	4	6	42	52	14
15:00:00	0	0	0	0	0	0	15:00:00	0	0	0	0	0
16:00:00	16	7	4	27	18	160	16:00:00	25	10	98	133	20
17:00:00	8	13	5	26	3	118	17:00:00	21	12	59	92	14
18:00:00	9	14	2	25	6	132	18:00:00	15	15	77	107	23
Totals:	67	75	25	167	62	651	S Totals:	78	52	354	484	119
East Approach Totals						East/West Total Approaches	West Approach Totals					
Hour Ending	Includes Cars, Trucks, & Buses				Total Peds		Hour Ending	Includes Cars, Trucks, & Buses				Total Peds
	Left	Thru	Right	Grand Total				Left	Thru	Right	Grand Total	
7:00:00	0	0	0	0	0	0	7:00:00	0	0	0	0	0
8:00:00	39	46	6	91	5	143	8:00:00	1	40	11	52	3
9:00:00	107	72	8	187	4	256	9:00:00	0	45	24	69	10
10:00:00	52	61	4	117	0	182	10:00:00	3	51	11	65	0
15:00:00	0	0	0	0	0	0	15:00:00	0	0	0	0	0
16:00:00	70	81	7	158	8	255	16:00:00	2	85	10	97	8
17:00:00	55	81	25	161	2	259	17:00:00	2	83	13	98	5
18:00:00	55	90	16	161	2	236	18:00:00	2	63	10	75	3
Totals:	378	431	66	875	21	1331	W Totals:	10	367	79	456	29
Calculated Values for Traffic Crossing Major Street												
Hours Ending:	7:00	8:00	9:00	10:00		15:00	16:00	17:00	18:00			
Crossing Values:	0	38	58	18		0	67	49	44			

<h2>Mid-day Peak Diagram</h2>	Specified Period From: 12:00:00 To: 15:00:00	One Hour Peak From: 12:00:00 To: 13:00:00																														
Municipality: Windsor Site #: 2217900002 Intersection: Little River Blvd & Clover Ave TFR File #: 1 Count date: 17-Sep-22	Weather conditions: Person counted: Person prepared: Person checked:																															
** Non-Signalized Intersection **		Major Road: Little River Blvd runs W/E																														
North Leg Total: 61 North Entering: 30 North Peds: 8 Peds Cross: ☒	<table style="margin: auto;"> <tr><td>Buses</td><td>0</td><td>0</td><td>0</td><td>0</td></tr> <tr><td>Trucks</td><td>0</td><td>0</td><td>0</td><td>0</td></tr> <tr><td>Cars</td><td>1</td><td>16</td><td>13</td><td>30</td></tr> <tr><td>Totals</td><td>1</td><td>16</td><td>13</td><td></td></tr> </table>	Buses	0	0	0	0	Trucks	0	0	0	0	Cars	1	16	13	30	Totals	1	16	13		 <table style="margin: auto;"> <tr><td>Buses</td><td>0</td></tr> <tr><td>Trucks</td><td>0</td></tr> <tr><td>Cars</td><td>31</td></tr> <tr><td>Totals</td><td>31</td></tr> </table>	Buses	0	Trucks	0	Cars	31	Totals	31	East Leg Total: 312 East Entering: 164 East Peds: 1 Peds Cross: ☒	
Buses	0	0	0	0																												
Trucks	0	0	0	0																												
Cars	1	16	13	30																												
Totals	1	16	13																													
Buses	0																															
Trucks	0																															
Cars	31																															
Totals	31																															
<table style="margin: auto;"> <tr><td>Buses</td><td>Trucks</td><td>Cars</td><td>Totals</td></tr> <tr><td>0</td><td>1</td><td>111</td><td>112</td></tr> </table>	Buses	Trucks	Cars	Totals	0	1	111	112	 <p style="text-align: center;">Clover Ave</p>	 <table style="margin: auto;"> <tr><td>Cars</td><td>Trucks</td><td>Buses</td><td>Totals</td></tr> <tr><td>13</td><td>0</td><td>0</td><td>13</td></tr> <tr><td>104</td><td>0</td><td>0</td><td>104</td></tr> <tr><td>47</td><td>0</td><td>0</td><td>47</td></tr> <tr><td>164</td><td>0</td><td>0</td><td></td></tr> </table>	Cars	Trucks	Buses	Totals	13	0	0	13	104	0	0	104	47	0	0	47	164	0	0		 <p style="text-align: center;">N S W E</p>	<p style="text-align: center;">Little River Blvd</p> 
Buses	Trucks	Cars	Totals																													
0	1	111	112																													
Cars	Trucks	Buses	Totals																													
13	0	0	13																													
104	0	0	104																													
47	0	0	47																													
164	0	0																														
<table style="margin: auto;"> <tr><td>Buses</td><td>Trucks</td><td>Cars</td><td>Totals</td></tr> <tr><td>0</td><td>0</td><td>4</td><td>4</td></tr> <tr><td>0</td><td>0</td><td>81</td><td>81</td></tr> <tr><td>0</td><td>0</td><td>13</td><td>13</td></tr> <tr><td>0</td><td>0</td><td>98</td><td></td></tr> </table>	Buses	Trucks	Cars	Totals	0	0	4	4	0	0	81	81	0	0	13	13	0	0	98			<p style="text-align: center;">Little River Blvd</p> 	<table style="margin: auto;"> <tr><td>Cars</td><td>Trucks</td><td>Buses</td><td>Totals</td></tr> <tr><td>147</td><td>0</td><td>1</td><td>148</td></tr> </table>	Cars	Trucks	Buses	Totals	147	0	1	148	
Buses	Trucks	Cars	Totals																													
0	0	4	4																													
0	0	81	81																													
0	0	13	13																													
0	0	98																														
Cars	Trucks	Buses	Totals																													
147	0	1	148																													
Peds Cross: ☒ West Peds: 2 West Entering: 98 West Leg Total: 210	 <table style="margin: auto;"> <tr><td>Cars</td><td>76</td></tr> <tr><td>Trucks</td><td>0</td></tr> <tr><td>Buses</td><td>0</td></tr> <tr><td>Totals</td><td>76</td></tr> </table>	Cars	76	Trucks	0	Buses	0	Totals	76	 <p style="text-align: center;">Clover Ave</p>	<table style="margin: auto;"> <tr><td>Cars</td><td>6</td><td>14</td><td>53</td><td>73</td></tr> <tr><td>Trucks</td><td>1</td><td>0</td><td>0</td><td>1</td></tr> <tr><td>Buses</td><td>0</td><td>0</td><td>1</td><td>1</td></tr> <tr><td>Totals</td><td>7</td><td>14</td><td>54</td><td></td></tr> </table>	Cars	6	14	53	73	Trucks	1	0	0	1	Buses	0	0	1	1	Totals	7	14	54		Peds Cross: ☒ South Peds: 23 South Entering: 75 South Leg Total: 151
Cars	76																															
Trucks	0																															
Buses	0																															
Totals	76																															
Cars	6	14	53	73																												
Trucks	1	0	0	1																												
Buses	0	0	1	1																												
Totals	7	14	54																													
<h3>Comments</h3>																																

Total Count Diagram

Municipality: Windsor
Site #: 2217900002
Intersection: Little River Blvd & Clover Ave
TFR File #: 1
Count date: 17-Sep-22

Weather conditions:

Person counted:
Person prepared:
Person checked:

**** Non-Signalized Intersection ****

Major Road: Little River Blvd runs W/E

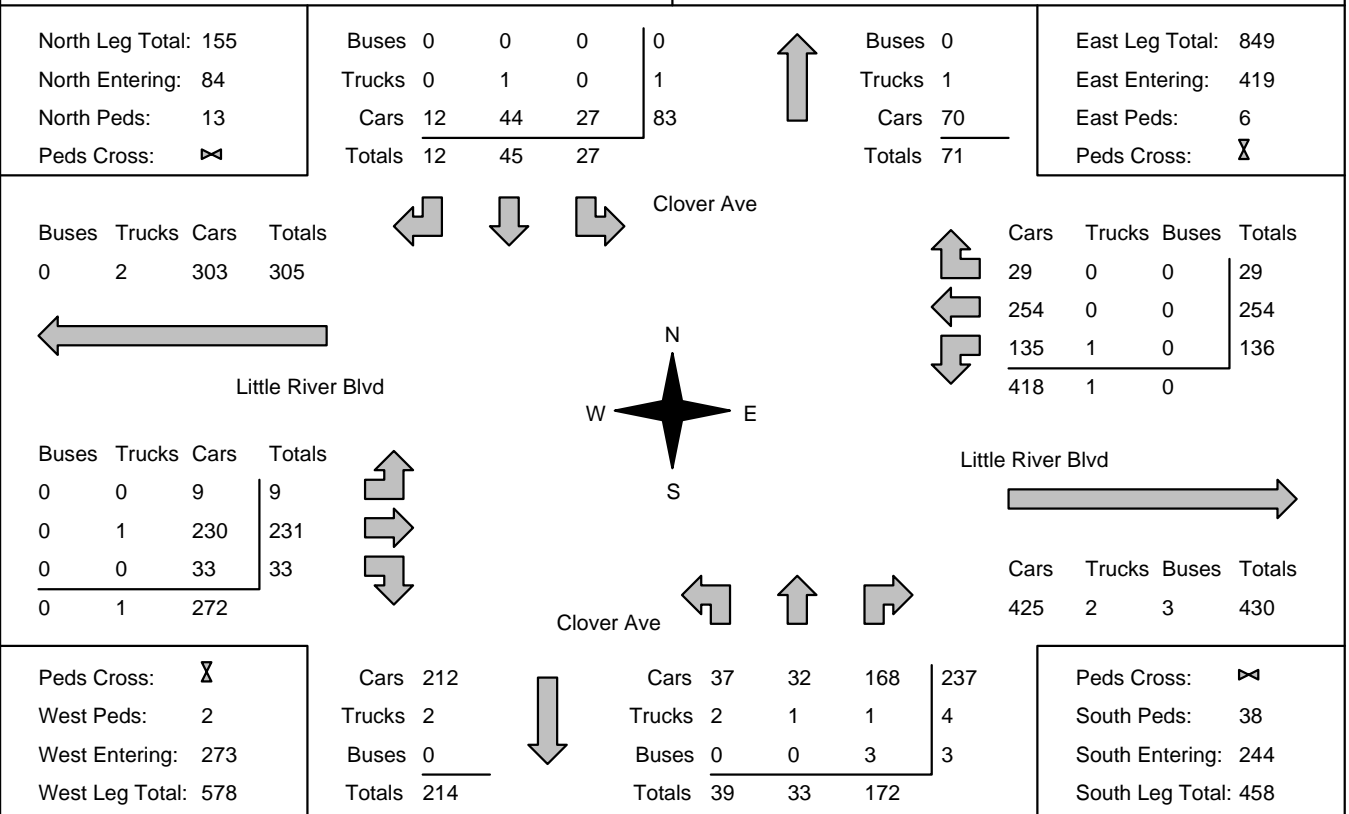

Comments

Traffic Count Summary

Intersection: Little River Blvd & Clover Ave Count Date: 17-Sep-22 Municipality: Windsor

North Approach Totals						North/South Total Approaches	South Approach Totals					
Hour Ending	Includes Cars, Trucks, & Buses				Total Peds		Hour Ending	Includes Cars, Trucks, & Buses				Total Peds
	Left	Thru	Right	Grand Total				Left	Thru	Right	Grand Total	
12:00:00	0	0	0	0	0	0	12:00:00	0	0	0	0	0
13:00:00	13	16	1	30	8	105	13:00:00	7	14	54	75	23
14:00:00	8	17	8	33	1	115	14:00:00	12	13	57	82	8
15:00:00	6	12	3	21	4	108	15:00:00	20	6	61	87	7
Totals:	27	45	12	84	13	328	S Totals:	39	33	172	244	38
East Approach Totals						East/West Total Approaches	West Approach Totals					
Hour Ending	Includes Cars, Trucks, & Buses				Total Peds		Hour Ending	Includes Cars, Trucks, & Buses				Total Peds
	Left	Thru	Right	Grand Total				Left	Thru	Right	Grand Total	
12:00:00	0	0	0	0	0	0	12:00:00	0	0	0	0	0
13:00:00	47	104	13	164	1	262	13:00:00	4	81	13	98	2
14:00:00	44	82	8	134	3	227	14:00:00	4	81	8	93	0
15:00:00	45	68	8	121	2	203	15:00:00	1	69	12	82	0
Totals:	136	254	29	419	6	692	W Totals:	9	231	33	273	2
Calculated Values for Traffic Crossing Major Street												
Hours Ending:	12:00	13:00	14:00	15:00		0:00	0:00	0:00	0:00			
Crossing Values:	0	39	40	40		0	0	0	0			

Ontario Traffic Inc.

Morning Peak Diagram

Specified Period

From: 7:00:00
To: 10:00:00

One Hour Peak

From: 8:00:00
To: 9:00:00

Municipality: Windsor
Site #: 1906900096
Intersection: Riverside Dr E & Greenpark Blvd
TFR File #: 4
Count date: 4-Apr-19

Weather conditions:
Person(s) who counted:

**** Non-Signalized Intersection ****

Major Road: Riverside Dr E runs W/E

East Leg Total: 745
East Entering: 482
East Peds: 0
Peds Cross: ∞

Heavys	Trucks	Cars	Totals
1	1	419	421



Riverside Dr E

Cars	Trucks	Heavys	Totals
407	1	1	409
67	6	0	73
474	7	1	

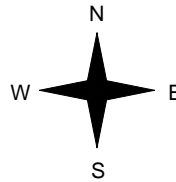

Heavys	Trucks	Cars	Totals
3	2	165	170
0	0	25	25
3	2	190	



Greenpark Blvd

Riverside Dr E



Peds Cross: ∞
West Peds: 0
West Entering: 195
West Leg Total: 616

Cars	92
Trucks	6
Heavys	0
Totals	98



Cars	12	89	101
Trucks	0	4	4
Heavys	0	0	0
Totals	12	93	

Peds Cross: ∞
South Peds: 0
South Entering: 105
South Leg Total: 203

Comments

Ontario Traffic Inc.

Mid-day Peak Diagram

Specified Period

From: 11:00:00
To: 14:00:00

One Hour Peak

From: 12:00:00
To: 13:00:00

Municipality: Windsor
Site #: 1906900096
Intersection: Riverside Dr E & Greenpark Blvd
TFR File #: 4
Count date: 4-Apr-19

Weather conditions:
Person(s) who counted:

**** Non-Signalized Intersection ****

Major Road: Riverside Dr E runs W/E

East Leg Total: 503
East Entering: 267
East Peds: 0
Peds Cross: ∞

Heavys	Trucks	Cars	Totals
0	0	250	250



Riverside Dr E

Cars	Trucks	Heavys	Totals
231	0	0	231
35	1	0	36
266	1	0	



Riverside Dr E



Heavys	Trucks	Cars	Totals
1	4	157	162
0	1	19	20
1	5	176	



Greenpark Blvd

Cars	Trucks	Heavys	Totals
228	7	1	236

Peds Cross: ∞
West Peds: 0
West Entering: 182
West Leg Total: 432

Cars	54
Trucks	2
Heavys	0
Totals	56



Cars	19	71	90
Trucks	0	3	3
Heavys	0	0	0
Totals	19	74	

Peds Cross: ∞
South Peds: 0
South Entering: 93
South Leg Total: 149

Comments

Ontario Traffic Inc.

Afternoon Peak Diagram

Specified Period

From: 15:00:00

To: 18:00:00

One Hour Peak

From: 16:45:00

To: 17:45:00

Municipality: Windsor
Site #: 1906900096
Intersection: Riverside Dr E & Greenpark Blvd
TFR File #: 4
Count date: 4-Apr-19

Weather conditions:
Person(s) who counted:

**** Non-Signalized Intersection ****

Major Road: Riverside Dr E runs W/E

East Leg Total: 822
 East Entering: 342
 East Peds: 0
 Peds Cross: ∞

Heavys	Trucks	Cars	Totals
0	1	312	313



Riverside Dr E

Cars	Trucks	Heavys	Totals
286	1	0	287
54	1	0	55
340	2	0	



Riverside Dr E



Heavys	Trucks	Cars	Totals
2	2	327	331
0	0	22	22
2	2	349	



Greenpark Blvd

Cars	Trucks	Heavys	Totals
475	3	2	480

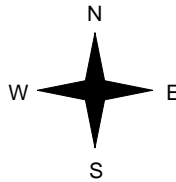

Peds Cross: ∞
 West Peds: 0
 West Entering: 353
 West Leg Total: 666

Cars	76
Trucks	1
Heavys	0
Totals	77



Cars	26	148	174
Trucks	0	1	1
Heavys	0	0	0
Totals	26	149	

Peds Cross: ∞
 South Peds: 0
 South Entering: 175
 South Leg Total: 252

Comments

Ontario Traffic Inc.

Total Count Diagram

Municipality: Windsor
Site #: 1906900096
Intersection: Riverside Dr E & Greenpark Blvd
TFR File #: 4
Count date: 4-Apr-19

Weather conditions:
Person(s) who counted:

**** Non-Signalized Intersection ****

Major Road: Riverside Dr E runs W/E

East Leg Total: 5406
 East Entering: 2766
 East Peds: 0
 Peds Cross: X

Heavys	Trucks	Cars	Totals
6	31	2454	2491



Riverside Dr E

Heavys	Trucks	Cars	Totals
10	29	1762	1801
0	8	155	163
10	37	1917	



Greenpark Blvd

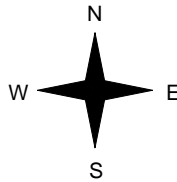

Cars	Trucks	Heavys	Totals
2304	24	5	2333
411	22	0	433
2715	46	5	



Riverside Dr E

Cars	Trucks	Heavys	Totals
2589	41	10	2640



Peds Cross: X
 West Peds: 0
 West Entering: 1964
 West Leg Total: 4455

Cars	566
Trucks	30
Heavys	0
Totals	596



Cars	150	827	977
Trucks	7	12	19
Heavys	1	0	1
Totals	158	839	

Peds Cross: X
 South Peds: 0
 South Entering: 997
 South Leg Total: 1593

Comments

Ontario Traffic Inc. Traffic Count Summary

Intersection: Riverside Dr E & Greenpark Blvd

Count Date: 4-Apr-19

Municipality: Windsor

North Approach Totals						North/South Total Approaches	South Approach Totals					
Hour Ending	Includes Cars, Trucks, & Heavys				Total Peds		Hour Ending	Includes Cars, Trucks, & Heavys				Total Peds
	Left	Thru	Right	Grand Total				Left	Thru	Right	Grand Total	
7:00:00	0	0	0	0	0	0	7:00:00	0	0	0	0	0
8:00:00	0	0	0	0	0	74	8:00:00	11	0	63	74	0
9:00:00	0	0	0	0	0	105	9:00:00	12	0	93	105	0
10:00:00	0	0	0	0	0	60	10:00:00	14	0	46	60	0
11:00:00	0	0	0	0	0	1	11:00:00	1	0	0	1	0
12:00:00	0	0	0	0	0	88	12:00:00	22	0	66	88	0
13:00:00	0	0	0	0	0	93	13:00:00	19	0	74	93	0
14:00:00	0	0	0	0	0	97	14:00:00	17	0	80	97	0
15:00:00	0	0	0	0	0	10	15:00:00	2	0	8	10	0
16:00:00	0	0	0	0	0	157	16:00:00	17	0	140	157	0
17:00:00	0	0	0	0	0	163	17:00:00	21	0	142	163	0
18:00:00	0	0	0	0	0	148	18:00:00	22	0	126	148	0
Totals:	0	0	0	0	0	996		158	0	838	996	0
East Approach Totals						East/West Total Approaches	West Approach Totals					
Hour Ending	Includes Cars, Trucks, & Heavys				Total Peds		Hour Ending	Includes Cars, Trucks, & Heavys				Total Peds
	Left	Thru	Right	Grand Total				Left	Thru	Right	Grand Total	
7:00:00	0	0	0	0	0	1	7:00:00	0	1	0	1	0
8:00:00	44	288	0	332	0	453	8:00:00	0	111	10	121	0
9:00:00	73	409	0	482	0	677	9:00:00	0	170	25	195	0
10:00:00	46	215	0	261	0	394	10:00:00	0	121	12	133	0
11:00:00	0	2	0	2	0	6	11:00:00	0	4	0	4	0
12:00:00	32	203	0	235	0	396	12:00:00	0	142	19	161	0
13:00:00	36	231	0	267	0	449	13:00:00	0	162	20	182	0
14:00:00	34	194	0	228	0	434	14:00:00	0	187	19	206	0
15:00:00	1	17	0	18	0	39	15:00:00	0	20	1	21	0
16:00:00	56	250	0	306	0	619	16:00:00	0	292	21	313	0
17:00:00	55	273	0	328	0	632	17:00:00	0	291	13	304	0
18:00:00	56	250	0	306	0	626	18:00:00	0	297	23	320	0
Totals:	433	2332	0	2765	0	4726		0	1798	163	1961	0
Calculated Values for Traffic Crossing Major Street												
Hours Ending:	8:00	9:00	12:00	13:00		14:00	16:00	17:00	18:00			
Crossing Values:	11	12	22	19		17	17	21	22			

Ontario Traffic Inc.

Count Date: 4-Apr-19 Site #: 1906900096

Interval Time	Passenger Cars - East Approach						Trucks - East Approach						Heavys - East Approach						Pedestrians	
	Left		Thru		Right		Left		Thru		Right		Left		Thru		Right		East Cross	
	Cum	Incr	Cum	Incr	Cum	Incr	Cum	Incr	Cum	Incr	Cum	Incr	Cum	Incr	Cum	Incr	Cum	Incr	Cum	Incr
7:00:00	0	0	0	0	0	0	0	0	0	0	0	0	0	0	0	0	0	0	0	0
7:15:00	10	10	42	42	0	0	0	0	0	0	0	0	0	0	0	0	0	0	0	0
7:30:00	19	9	107	65	0	0	1	1	1	1	0	0	0	0	0	0	0	0	0	0
7:45:00	29	10	204	97	0	0	3	2	3	2	0	0	0	0	1	1	0	0	0	0
8:00:00	41	12	282	78	0	0	3	0	4	1	0	0	0	0	2	1	0	0	0	0
8:15:00	61	20	386	104	0	0	5	2	4	0	0	0	0	0	2	0	0	0	0	0
8:30:00	69	8	482	96	0	0	6	1	4	0	0	0	0	0	2	0	0	0	0	0
8:45:00	93	24	581	99	0	0	9	3	4	0	0	0	0	0	3	1	0	0	0	0
9:00:00	108	15	689	108	0	0	9	0	5	1	0	0	0	0	3	0	0	0	0	0
9:15:00	125	17	752	63	0	0	10	1	11	6	0	0	0	0	4	1	0	0	0	0
9:30:00	136	11	805	53	0	0	11	1	11	0	0	0	0	0	5	1	0	0	0	0
9:45:00	145	9	844	39	0	0	11	0	12	1	0	0	0	0	5	0	0	0	0	0
10:00:00	152	7	893	49	0	0	11	0	14	2	0	0	0	0	5	0	0	0	0	0
10:00:17	152	0	895	2	0	0	11	0	14	0	0	0	0	0	5	0	0	0	0	0
11:00:00	152	0	895	0	0	0	11	0	14	0	0	0	0	0	5	0	0	0	0	0
11:15:00	161	9	954	59	0	0	11	0	15	1	0	0	0	0	5	0	0	0	0	0
11:30:00	168	7	988	34	0	0	12	1	17	2	0	0	0	0	5	0	0	0	0	0
11:45:00	177	9	1048	60	0	0	12	0	17	0	0	0	0	0	5	0	0	0	0	0
12:00:00	182	5	1095	47	0	0	13	1	17	0	0	0	0	0	5	0	0	0	0	0
12:15:00	192	10	1146	51	0	0	13	0	17	0	0	0	0	0	5	0	0	0	0	0
12:30:00	197	5	1204	58	0	0	13	0	17	0	0	0	0	0	5	0	0	0	0	0
12:45:00	206	9	1262	58	0	0	14	1	17	0	0	0	0	0	5	0	0	0	0	0
13:00:00	217	11	1326	64	0	0	14	0	17	0	0	0	0	0	5	0	0	0	0	0
13:15:00	222	5	1361	35	0	0	15	1	17	0	0	0	0	0	5	0	0	0	0	0
13:30:00	231	9	1417	56	0	0	15	0	18	1	0	0	0	0	5	0	0	0	0	0
13:45:00	237	6	1466	49	0	0	16	1	19	1	0	0	0	0	5	0	0	0	0	0
14:00:00	249	12	1518	52	0	0	16	0	19	0	0	0	0	0	5	0	0	0	0	0
14:05:38	250	1	1534	16	0	0	16	0	20	1	0	0	0	0	5	0	0	0	0	0
15:00:00	250	0	1534	0	0	0	16	0	20	0	0	0	0	0	5	0	0	0	0	0
15:15:00	260	10	1585	51	0	0	16	0	20	0	0	0	0	0	5	0	0	0	0	0
15:30:00	272	12	1645	60	0	0	16	0	20	0	0	0	0	0	5	0	0	0	0	0
15:45:00	291	19	1713	68	0	0	17	1	20	0	0	0	0	0	5	0	0	0	0	0
16:00:00	304	13	1784	71	0	0	18	1	20	0	0	0	0	0	5	0	0	0	0	0
16:15:00	318	14	1859	75	0	0	19	1	22	2	0	0	0	0	5	0	0	0	0	0
16:30:00	335	17	1928	69	0	0	20	1	22	0	0	0	0	0	5	0	0	0	0	0
16:45:00	346	11	1976	48	0	0	21	1	23	1	0	0	0	0	5	0	0	0	0	0
17:00:00	356	10	2054	78	0	0	21	0	23	0	0	0	0	0	5	0	0	0	0	0
17:15:00	371	15	2130	76	0	0	21	0	23	0	0	0	0	0	5	0	0	0	0	0
17:30:00	390	19	2208	78	0	0	22	1	24	1	0	0	0	0	5	0	0	0	0	0
17:45:00	400	10	2262	54	0	0	22	0	24	0	0	0	0	0	5	0	0	0	0	0

Ontario Traffic Inc.

Count Date: 4-Apr-19 Site #: 1906900096

Interval Time	Passenger Cars - South Approach						Trucks - South Approach						Heavys - South Approach						Pedestrians	
	Left		Thru		Right		Left		Thru		Right		Left		Thru		Right		South Cross	
	Cum	Incr	Cum	Incr	Cum	Incr	Cum	Incr	Cum	Incr	Cum	Incr	Cum	Incr	Cum	Incr	Cum	Incr	Cum	Incr
7:00:00	0	0	0	0	0	0	0	0	0	0	0	0	0	0	0	0	0	0	0	0
7:15:00	2	2	0	0	12	12	1	1	0	0	0	0	1	1	0	0	0	0	0	0
7:30:00	3	1	0	0	24	12	1	0	0	0	0	0	1	0	0	0	0	0	0	0
7:45:00	4	1	0	0	39	15	4	3	0	0	0	0	1	0	0	0	0	0	0	0
8:00:00	6	2	0	0	63	24	4	0	0	0	0	0	1	0	0	0	0	0	0	0
8:15:00	11	5	0	0	85	22	4	0	0	0	0	0	1	0	0	0	0	0	0	0
8:30:00	15	4	0	0	108	23	4	0	0	0	2	2	1	0	0	0	0	0	0	0
8:45:00	15	0	0	0	130	22	4	0	0	0	4	2	1	0	0	0	0	0	0	0
9:00:00	18	3	0	0	152	22	4	0	0	0	4	0	1	0	0	0	0	0	0	0
9:15:00	20	2	0	0	169	17	4	0	0	0	4	0	1	0	0	0	0	0	0	0
9:30:00	24	4	0	0	179	10	4	0	0	0	4	0	1	0	0	0	0	0	0	0
9:45:00	29	5	0	0	188	9	4	0	0	0	4	0	1	0	0	0	0	0	0	0
10:00:00	32	3	0	0	198	10	4	0	0	0	4	0	1	0	0	0	0	0	0	0
10:00:17	33	1	0	0	198	0	4	0	0	0	4	0	1	0	0	0	0	0	0	0
11:00:00	33	0	0	0	198	0	4	0	0	0	4	0	1	0	0	0	0	0	0	0
11:15:00	37	4	0	0	218	20	4	0	0	0	4	0	1	0	0	0	0	0	0	0
11:30:00	41	4	0	0	225	7	4	0	0	0	4	0	1	0	0	0	0	0	0	0
11:45:00	49	8	0	0	238	13	4	0	0	0	4	0	1	0	0	0	0	0	0	0
12:00:00	54	5	0	0	263	25	5	1	0	0	5	1	1	0	0	0	0	0	0	0
12:15:00	59	5	0	0	284	21	5	0	0	0	6	1	1	0	0	0	0	0	0	0
12:30:00	66	7	0	0	294	10	5	0	0	0	6	0	1	0	0	0	0	0	0	0
12:45:00	71	5	0	0	309	15	5	0	0	0	8	2	1	0	0	0	0	0	0	0
13:00:00	73	2	0	0	334	25	5	0	0	0	8	0	1	0	0	0	0	0	0	0
13:15:00	75	2	0	0	357	23	5	0	0	0	8	0	1	0	0	0	0	0	0	0
13:30:00	76	1	0	0	378	21	5	0	0	0	8	0	1	0	0	0	0	0	0	0
13:45:00	81	5	0	0	399	21	5	0	0	0	8	0	1	0	0	0	0	0	0	0
14:00:00	90	9	0	0	414	15	5	0	0	0	8	0	1	0	0	0	0	0	0	0
14:05:38	92	2	0	0	422	8	5	0	0	0	8	0	1	0	0	0	0	0	0	0
15:00:00	92	0	0	0	422	0	5	0	0	0	8	0	1	0	0	0	0	0	0	0
15:15:00	95	3	0	0	449	27	6	1	0	0	9	1	1	0	0	0	0	0	0	0
15:30:00	96	1	0	0	482	33	7	1	0	0	9	0	1	0	0	0	0	0	0	0
15:45:00	98	2	0	0	521	39	7	0	0	0	9	0	1	0	0	0	0	0	0	0
16:00:00	107	9	0	0	560	39	7	0	0	0	10	1	1	0	0	0	0	0	0	0
16:15:00	111	4	0	0	589	29	7	0	0	0	11	1	1	0	0	0	0	0	0	0
16:30:00	116	5	0	0	632	43	7	0	0	0	11	0	1	0	0	0	0	0	0	0
16:45:00	120	4	0	0	661	29	7	0	0	0	11	0	1	0	0	0	0	0	0	0
17:00:00	128	8	0	0	701	40	7	0	0	0	11	0	1	0	0	0	0	0	0	0
17:15:00	133	5	0	0	733	32	7	0	0	0	11	0	1	0	0	0	0	0	0	0
17:30:00	138	5	0	0	774	41	7	0	0	0	11	0	1	0	0	0	0	0	0	0
17:45:00	146	8	0	0	809	35	7	0	0	0	12	1	1	0	0	0	0	0	0	0

Ontario Traffic Inc.

Count Date: 4-Apr-19 Site #: 1906900096

Interval Time	Passenger Cars - West Approach						Trucks - West Approach						Heavys - West Approach						Pedestrians	
	Left		Thru		Right		Left		Thru		Right		Left		Thru		Right		West Cross	
	Cum	Incr	Cum	Incr	Cum	Incr	Cum	Incr	Cum	Incr	Cum	Incr	Cum	Incr	Cum	Incr	Cum	Incr	Cum	Incr
7:00:00	0	0	1	1	0	0	0	0	0	0	0	0	0	0	0	0	0	0	0	0
7:15:00	0	0	17	16	1	1	0	0	0	0	0	0	0	0	0	0	0	0	0	0
7:30:00	0	0	41	24	5	4	0	0	0	0	0	0	0	0	0	0	0	0	0	0
7:45:00	0	0	76	35	7	2	0	0	2	2	1	1	0	0	0	0	0	0	0	0
8:00:00	0	0	108	32	9	2	0	0	3	1	1	0	0	0	1	1	0	0	0	0
8:15:00	0	0	152	44	18	9	0	0	3	0	1	0	0	0	3	2	0	0	0	0
8:30:00	0	0	198	46	23	5	0	0	4	1	1	0	0	0	4	1	0	0	0	0
8:45:00	0	0	231	33	31	8	0	0	5	1	1	0	0	0	4	0	0	0	0	0
9:00:00	0	0	273	42	34	3	0	0	5	0	1	0	0	0	4	0	0	0	0	0
9:15:00	0	0	313	40	39	5	0	0	6	1	1	0	0	0	4	0	0	0	0	0
9:30:00	0	0	336	23	43	4	0	0	6	0	1	0	0	0	4	0	0	0	0	0
9:45:00	0	0	362	26	45	2	0	0	7	1	1	0	0	0	4	0	0	0	0	0
10:00:00	0	0	390	28	46	1	0	0	8	1	1	0	0	0	5	1	0	0	0	0
10:00:17	0	0	393	3	46	0	0	0	8	0	1	0	0	0	5	0	0	0	0	0
11:00:00	0	0	394	1	46	0	0	0	8	0	1	0	0	0	5	0	0	0	0	0
11:15:00	0	0	425	31	48	2	0	0	9	1	2	1	0	0	6	1	0	0	0	0
11:30:00	0	0	461	36	51	3	0	0	9	0	2	0	0	0	7	1	0	0	0	0
11:45:00	0	0	503	42	59	8	0	0	11	2	3	1	0	0	7	0	0	0	0	0
12:00:00	0	0	531	28	63	4	0	0	11	0	3	0	0	0	7	0	0	0	0	0
12:15:00	0	0	572	41	67	4	0	0	12	1	3	0	0	0	8	1	0	0	0	0
12:30:00	0	0	606	34	75	8	0	0	12	0	4	1	0	0	8	0	0	0	0	0
12:45:00	0	0	646	40	77	2	0	0	12	0	4	0	0	0	8	0	0	0	0	0
13:00:00	0	0	688	42	82	5	0	0	15	3	4	0	0	0	8	0	0	0	0	0
13:15:00	0	0	729	41	83	1	0	0	15	0	4	0	0	0	8	0	0	0	0	0
13:30:00	0	0	772	43	84	1	0	0	15	0	4	0	0	0	8	0	0	0	0	0
13:45:00	0	0	827	55	89	5	0	0	16	1	4	0	0	0	8	0	0	0	0	0
14:00:00	0	0	871	44	99	10	0	0	19	3	6	2	0	0	8	0	0	0	0	0
14:05:38	0	0	889	18	100	1	0	0	20	1	6	0	0	0	8	0	0	0	0	0
15:00:00	0	0	890	1	100	0	0	0	20	0	6	0	0	0	8	0	0	0	0	0
15:15:00	0	0	950	60	106	6	0	0	23	3	7	1	0	0	8	0	0	0	0	0
15:30:00	0	0	1025	75	109	3	0	0	23	0	7	0	0	0	8	0	0	0	0	0
15:45:00	0	0	1103	78	114	5	0	0	25	2	8	1	0	0	8	0	0	0	0	0
16:00:00	0	0	1177	74	119	5	0	0	25	0	8	0	0	0	8	0	0	0	0	0
16:15:00	0	0	1251	74	122	3	0	0	25	0	8	0	0	0	8	0	0	0	0	0
16:30:00	0	0	1314	63	126	4	0	0	26	1	8	0	0	0	8	0	0	0	0	0
16:45:00	0	0	1383	69	129	3	0	0	27	1	8	0	0	0	8	0	0	0	0	0
17:00:00	0	0	1464	81	132	3	0	0	29	2	8	0	0	0	8	0	0	0	0	0
17:15:00	0	0	1556	92	140	8	0	0	29	0	8	0	0	0	8	0	0	0	0	0
17:30:00	0	0	1638	82	146	6	0	0	29	0	8	0	0	0	9	1	0	0	0	0
17:45:00	0	0	1710	72	151	5	0	0	29	0	8	0	0	0	10	1	0	0	0	0

Ontario Traffic Inc.

Morning Peak Diagram

Specified Period

From: 7:00:00
To: 10:00:00

One Hour Peak

From: 7:45:00
To: 8:45:00

Municipality: Windsor
Site #: 1906900092
Intersection: Wyandotte St E & Banwell Rd
TFR File #: 1
Count date: 1-Apr-19

Weather conditions:
Person(s) who counted:

**** Non-Signalized Intersection ****

Major Road: Wyandotte St E runs W/E

North Leg Total: 26
North Entering: 15
North Peds: 14
Peds Cross: \bowtie

Heavys	0	1	0	1
Trucks	0	0	0	0
Cars	5	9	0	14
Totals	5	10	0	



Heavys	2
Trucks	1
Cars	8
Totals	11

East Leg Total: 0
East Entering: 0
East Peds: 15
Peds Cross: \bowtie

Heavys	2
Trucks	5
Cars	248
Totals	255



Banwell Rd

Cars	0	0	0	0
Trucks	0	0	0	0
Heavys	0	0	0	0
Totals	0	0	0	0



Wyandotte St E

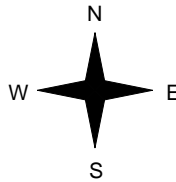

Heavys	1
Trucks	0
Cars	3
Totals	4
Heavys	0
Trucks	0
Cars	0
Totals	0
Heavys	2
Trucks	2
Cars	133
Totals	137
Heavys	3
Trucks	2
Cars	136
Totals	

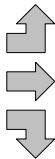

Wyandotte St E



Cars	0	0	0	0
Trucks	0	0	0	0
Heavys	0	0	0	0
Totals	0	0	0	0

Peds Cross: \bowtie
West Peds: 0
West Entering: 141
West Leg Total: 396

Cars	142	Cars	243	5	0	248
Trucks	2	Trucks	5	1	0	6
Heavys	3	Heavys	2	1	0	3
Totals	147	Totals	250	7	0	



Peds Cross: \bowtie
South Peds: 0
South Entering: 257
South Leg Total: 404

Comments

Ontario Traffic Inc.

Mid-day Peak Diagram

Specified Period

From: 11:00:00
To: 14:00:00

One Hour Peak

From: 13:00:00
To: 14:00:00

Municipality: Windsor
Site #: 1906900092
Intersection: Wyandotte St E & Banwell Rd
TFR File #: 1
Count date: 1-Apr-19

Weather conditions:
Person(s) who counted:

**** Non-Signalized Intersection ****

Major Road: Wyandotte St E runs W/E

North Leg Total: 28
North Entering: 9
North Peds: 0
Peds Cross: \bowtie

Heavys	0	0	0	0
Trucks	0	1	0	1
Cars	1	7	0	8
Totals	1	8	0	



Heavys	0
Trucks	1
Cars	18
Totals	19

East Leg Total: 0
East Entering: 0
East Peds: 2
Peds Cross: \bowtie

Heavys	Trucks	Cars	Totals
1	5	133	139



Banwell Rd

Cars	Trucks	Heavys	Totals
0	0	0	0
0	0	0	0
0	0	0	0
0	0	0	0



Wyandotte St E

Heavys	Trucks	Cars	Totals
0	1	9	10
0	0	0	0
0	1	182	183
0	2	191	

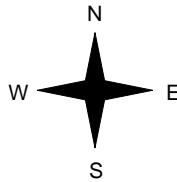
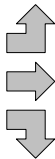

Wyandotte St E



Cars	Trucks	Heavys	Totals
0	0	0	0

Peds Cross: \bowtie
West Peds: 0
West Entering: 193
West Leg Total: 332

Cars	189	Cars	132	9	0	141
Trucks	2	Trucks	5	0	0	5
Heavys	0	Heavys	1	0	0	1
Totals	191	Totals	138	9	0	



Peds Cross: \bowtie
South Peds: 0
South Entering: 147
South Leg Total: 338

Comments

Ontario Traffic Inc.

Afternoon Peak Diagram

Specified Period

From: 15:00:00

To: 18:00:00

One Hour Peak

From: 16:45:00

To: 17:45:00

Municipality: Windsor
Site #: 1906900092
Intersection: Wyandotte St E & Banwell Rd
TFR File #: 1
Count date: 1-Apr-19

Weather conditions:
Person(s) who counted:

**** Non-Signalized Intersection ****

Major Road: Wyandotte St E runs W/E

North Leg Total: 38
 North Entering: 13
 North Peds: 1
 Peds Cross: \times

Heavys	0	0	0	0
Trucks	0	0	0	0
Cars	2	11	0	13
Totals	2	11	0	



Heavys	0
Trucks	0
Cars	25
Totals	25

East Leg Total: 0
 East Entering: 0
 East Peds: 0
 Peds Cross: \times

Heavys	Trucks	Cars	Totals
0	2	190	192



Banwell Rd

Cars	Trucks	Heavys	Totals
0	0	0	0
0	0	0	0
0	0	0	0
0	0	0	0



Wyandotte St E

Heavys	Trucks	Cars	Totals
0	0	9	9
0	0	0	0
0	1	343	344
0	1	352	

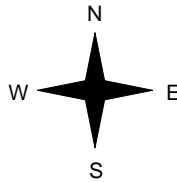
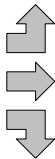

Wyandotte St E



Cars	Trucks	Heavys	Totals
0	0	0	0

Peds Cross: \times
 West Peds: 0
 West Entering: 353
 West Leg Total: 545

Cars	354	Cars	188	16	0	204
Trucks	1	Trucks	2	0	0	2
Heavys	0	Heavys	0	0	0	0
Totals	355	Totals	190	16	0	



Banwell Rd



Peds Cross: \times
 South Peds: 0
 South Entering: 206
 South Leg Total: 561

Comments

Ontario Traffic Inc.

Total Count Diagram

Municipality: Windsor
Site #: 1906900092
Intersection: Wyandotte St E & Banwell Rd
TFR File #: 1
Count date: 1-Apr-19

Weather conditions:
Person(s) who counted:

**** Non-Signalized Intersection ****

Major Road: Wyandotte St E runs W/E

North Leg Total: 244
 North Entering: 89
 North Peds: 18
 Peds Cross: \times

Heavys	0	1	0	1
Trucks	0	1	0	1
Cars	19	68	0	87
Totals	19	70	0	



Heavys	2
Trucks	6
Cars	147
Totals	155

East Leg Total: 8
 East Entering: 1
 East Peds: 23
 Peds Cross: \times

Heavys	Trucks	Cars	Totals
14	41	1462	1517



Banwell Rd

Cars	Trucks	Heavys	Totals
0	0	0	0
1	0	0	1
0	0	0	0
1	0	0	



Wyandotte St E

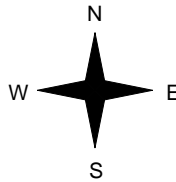

Heavys	Trucks	Cars	Totals
1	3	60	64
0	0	7	7
10	16	1812	1838
11	19	1879	

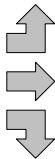

Banwell Rd

Wyandotte St E



Cars	Trucks	Heavys	Totals
7	0	0	7

Peds Cross: \times
 West Peds: 1
 West Entering: 1909
 West Leg Total: 3426

Cars	1880
Trucks	17
Heavys	11
Totals	1908



Cars	1442	87	0	1529
Trucks	41	3	0	44
Heavys	14	1	0	15
Totals	1497	91	0	

Peds Cross: \times
 South Peds: 11
 South Entering: 1588
 South Leg Total: 3496

Comments

Ontario Traffic Inc. Traffic Count Summary

Intersection: Wyandotte St E & Banwell Rd

Count Date: 1-Apr-19

Municipality: Windsor

North Approach Totals						North/South Total Approaches	South Approach Totals					
Hour Ending	Includes Cars, Trucks, & Heavys				Total Peds		Hour Ending	Includes Cars, Trucks, & Heavys				Total Peds
	Left	Thru	Right	Grand Total				Left	Thru	Right	Grand Total	
7:00:00	0	0	0	0	0	0	7:00:00	0	0	0	0	0
8:00:00	0	6	5	11	0	225	8:00:00	210	4	0	214	0
9:00:00	0	8	3	11	14	250	9:00:00	230	9	0	239	0
10:00:00	0	7	2	9	1	157	10:00:00	141	7	0	148	0
11:00:00	0	0	0	0	0	0	11:00:00	0	0	0	0	0
12:00:00	0	6	4	10	0	156	12:00:00	140	6	0	146	1
13:00:00	0	7	1	8	0	125	13:00:00	110	7	0	117	0
14:00:00	0	8	1	9	0	156	14:00:00	138	9	0	147	0
15:00:00	0	0	0	0	0	0	15:00:00	0	0	0	0	0
16:00:00	0	3	0	3	0	172	16:00:00	155	14	0	169	1
17:00:00	0	16	0	16	2	214	17:00:00	177	21	0	198	9
18:00:00	0	9	3	12	1	222	18:00:00	196	14	0	210	0
Totals:	0	70	19	89	18	1677		1497	91	0	1588	11
East Approach Totals						East/West Total Approaches	West Approach Totals					
Hour Ending	Includes Cars, Trucks, & Heavys				Total Peds		Hour Ending	Includes Cars, Trucks, & Heavys				Total Peds
	Left	Thru	Right	Grand Total				Left	Thru	Right	Grand Total	
7:00:00	0	0	0	0	0	1	7:00:00	0	1	0	1	0
8:00:00	0	0	0	0	1	113	8:00:00	1	0	112	113	0
9:00:00	0	0	0	0	14	146	9:00:00	6	0	140	146	0
10:00:00	0	0	0	0	2	125	10:00:00	5	0	120	125	0
11:00:00	0	0	0	0	0	3	11:00:00	0	2	1	3	0
12:00:00	0	0	0	0	0	177	12:00:00	5	1	171	177	0
13:00:00	0	1	0	1	0	143	13:00:00	3	0	139	142	0
14:00:00	0	0	0	0	2	193	14:00:00	10	0	183	193	0
15:00:00	0	0	0	0	0	2	15:00:00	0	2	0	2	0
16:00:00	0	0	0	0	0	316	16:00:00	13	0	303	316	0
17:00:00	0	0	0	0	4	357	17:00:00	11	0	346	357	1
18:00:00	0	0	0	0	0	333	18:00:00	10	0	323	333	0
Totals:	0	1	0	1	23	1909		64	6	1838	1908	1
Calculated Values for Traffic Crossing Major Street												
Hours Ending:	8:00	9:00	10:00	12:00				14:00	16:00	17:00	18:00	
Crossing Values:	217	253	150	146				149	169	203	210	

Ontario Traffic Inc.

Count Date: 1-Apr-19 Site #: 1906900092

Interval Time	Passenger Cars - North Approach						Trucks - North Approach						Heavys - North Approach						Pedestrians	
	Left		Thru		Right		Left		Thru		Right		Left		Thru		Right		North Cross	
	Cum	Incr	Cum	Incr	Cum	Incr	Cum	Incr	Cum	Incr	Cum	Incr	Cum	Incr	Cum	Incr	Cum	Incr	Cum	Incr
7:00:00	0	0	0	0	0	0	0	0	0	0	0	0	0	0	0	0	0	0	0	0
7:15:00	0	0	0	0	1	1	0	0	0	0	0	0	0	0	0	0	0	0	0	0
7:30:00	0	0	0	0	2	1	0	0	0	0	0	0	0	0	0	0	0	0	0	0
7:45:00	0	0	4	4	2	0	0	0	0	0	0	0	0	0	0	0	0	0	0	0
8:00:00	0	0	6	2	5	3	0	0	0	0	0	0	0	0	0	0	0	0	0	0
8:15:00	0	0	7	1	6	1	0	0	0	0	0	0	0	0	0	0	0	0	1	1
8:30:00	0	0	10	3	7	1	0	0	0	0	0	0	0	0	1	1	0	0	4	3
8:45:00	0	0	13	3	7	0	0	0	0	0	0	0	0	0	1	0	0	0	14	10
9:00:00	0	0	13	0	8	1	0	0	0	0	0	0	0	0	1	0	0	0	14	0
9:15:00	0	0	16	3	8	0	0	0	0	0	0	0	0	0	1	0	0	0	14	0
9:30:00	0	0	18	2	8	0	0	0	0	0	0	0	0	0	1	0	0	0	15	1
9:45:00	0	0	19	1	8	0	0	0	0	0	0	0	0	0	1	0	0	0	15	0
10:00:00	0	0	20	1	10	2	0	0	0	0	0	0	0	0	1	0	0	0	15	0
10:00:16	0	0	20	0	10	0	0	0	0	0	0	0	0	0	1	0	0	0	15	0
11:00:00	0	0	20	0	10	0	0	0	0	0	0	0	0	0	1	0	0	0	15	0
11:15:00	0	0	21	1	11	1	0	0	0	0	0	0	0	0	1	0	0	0	15	0
11:30:00	0	0	22	1	11	0	0	0	0	0	0	0	0	0	1	0	0	0	15	0
11:45:00	0	0	24	2	13	2	0	0	0	0	0	0	0	0	1	0	0	0	15	0
12:00:00	0	0	26	2	14	1	0	0	0	0	0	0	0	0	1	0	0	0	15	0
12:15:00	0	0	27	1	15	1	0	0	0	0	0	0	0	0	1	0	0	0	15	0
12:30:00	0	0	28	1	15	0	0	0	0	0	0	0	0	0	1	0	0	0	15	0
12:45:00	0	0	31	3	15	0	0	0	0	0	0	0	0	0	1	0	0	0	15	0
13:00:00	0	0	33	2	15	0	0	0	0	0	0	0	0	0	1	0	0	0	15	0
13:15:00	0	0	36	3	16	1	0	0	0	0	0	0	0	0	1	0	0	0	15	0
13:30:00	0	0	38	2	16	0	0	0	1	1	0	0	0	0	1	0	0	0	15	0
13:45:00	0	0	39	1	16	0	0	0	1	0	0	0	0	0	1	0	0	0	15	0
14:00:00	0	0	40	1	16	0	0	0	1	0	0	0	0	0	1	0	0	0	15	0
14:00:06	0	0	40	0	16	0	0	0	1	0	0	0	0	0	1	0	0	0	15	0
15:00:00	0	0	40	0	16	0	0	0	1	0	0	0	0	0	1	0	0	0	15	0
15:15:00	0	0	41	1	16	0	0	0	1	0	0	0	0	0	1	0	0	0	15	0
15:30:00	0	0	42	1	16	0	0	0	1	0	0	0	0	0	1	0	0	0	15	0
15:45:00	0	0	42	0	16	0	0	0	1	0	0	0	0	0	1	0	0	0	15	0
16:00:00	0	0	43	1	16	0	0	0	1	0	0	0	0	0	1	0	0	0	15	0
16:15:00	0	0	50	7	16	0	0	0	1	0	0	0	0	0	1	0	0	0	15	0
16:30:00	0	0	50	0	16	0	0	0	1	0	0	0	0	0	1	0	0	0	15	0
16:45:00	0	0	55	5	16	0	0	0	1	0	0	0	0	0	1	0	0	0	16	1
17:00:00	0	0	59	4	16	0	0	0	1	0	0	0	0	0	1	0	0	0	17	1
17:15:00	0	0	60	1	17	1	0	0	1	0	0	0	0	0	1	0	0	0	17	0
17:30:00	0	0	62	2	17	0	0	0	1	0	0	0	0	0	1	0	0	0	17	0
17:45:00	0	0	66	4	18	1	0	0	1	0	0	0	0	0	1	0	0	0	17	0

Ontario Traffic Inc.

Count Date: 1-Apr-19 Site #: 1906900092

Interval Time	Passenger Cars - South Approach						Trucks - South Approach						Heavys - South Approach						Pedestrians	
	Left		Thru		Right		Left		Thru		Right		Left		Thru		Right		South Cross	
	Cum	Incr	Cum	Incr	Cum	Incr	Cum	Incr	Cum	Incr	Cum	Incr	Cum	Incr	Cum	Incr	Cum	Incr	Cum	Incr
7:00:00	0	0	0	0	0	0	0	0	0	0	0	0	0	0	0	0	0	0	0	0
7:15:00	21	21	0	0	0	0	3	3	0	0	0	0	1	1	0	0	0	0	0	0
7:30:00	68	47	0	0	0	0	6	3	0	0	0	0	3	2	0	0	0	0	0	0
7:45:00	121	53	2	2	0	0	9	3	0	0	0	0	3	0	0	0	0	0	0	0
8:00:00	197	76	4	2	0	0	9	0	0	0	0	0	4	1	0	0	0	0	0	0
8:15:00	257	60	5	1	0	0	11	2	0	0	0	0	4	0	1	1	0	0	0	0
8:30:00	316	59	5	0	0	0	12	1	0	0	0	0	4	0	1	0	0	0	0	0
8:45:00	364	48	7	2	0	0	14	2	1	1	0	0	5	1	1	0	0	0	0	0
9:00:00	416	52	11	4	0	0	16	2	1	0	0	0	8	3	1	0	0	0	0	0
9:15:00	445	29	11	0	0	0	16	0	1	0	0	0	9	1	1	0	0	0	0	0
9:30:00	488	43	13	2	0	0	19	3	2	1	0	0	9	0	1	0	0	0	0	0
9:45:00	516	28	17	4	0	0	19	0	2	0	0	0	9	0	1	0	0	0	0	0
10:00:00	552	36	17	0	0	0	19	0	2	0	0	0	10	1	1	0	0	0	0	0
10:00:16	552	0	17	0	0	0	19	0	2	0	0	0	10	0	1	0	0	0	0	0
11:00:00	552	0	17	0	0	0	19	0	2	0	0	0	10	0	1	0	0	0	0	0
11:15:00	591	39	20	3	0	0	19	0	2	0	0	0	11	1	1	0	0	0	1	1
11:30:00	634	43	21	1	0	0	20	1	2	0	0	0	11	0	1	0	0	0	1	0
11:45:00	663	29	23	2	0	0	21	1	2	0	0	0	11	0	1	0	0	0	1	0
12:00:00	689	26	23	0	0	0	21	0	2	0	0	0	11	0	1	0	0	0	1	0
12:15:00	721	32	26	3	0	0	21	0	2	0	0	0	11	0	1	0	0	0	1	0
12:30:00	747	26	26	0	0	0	21	0	2	0	0	0	11	0	1	0	0	0	1	0
12:45:00	769	22	28	2	0	0	24	3	2	0	0	0	11	0	1	0	0	0	1	0
13:00:00	795	26	30	2	0	0	24	0	2	0	0	0	12	1	1	0	0	0	1	0
13:15:00	825	30	31	1	0	0	25	1	2	0	0	0	12	0	1	0	0	0	1	0
13:30:00	853	28	35	4	0	0	27	2	2	0	0	0	12	0	1	0	0	0	1	0
13:45:00	889	36	39	4	0	0	28	1	2	0	0	0	13	1	1	0	0	0	1	0
14:00:00	927	38	39	0	0	0	29	1	2	0	0	0	13	0	1	0	0	0	1	0
14:00:06	927	0	39	0	0	0	29	0	2	0	0	0	13	0	1	0	0	0	1	0
15:00:00	927	0	39	0	0	0	29	0	2	0	0	0	13	0	1	0	0	0	1	0
15:15:00	969	42	43	4	0	0	32	3	3	1	0	0	14	1	1	0	0	0	1	0
15:30:00	1017	48	47	4	0	0	32	0	3	0	0	0	14	0	1	0	0	0	1	0
15:45:00	1040	23	50	3	0	0	33	1	3	0	0	0	14	0	1	0	0	0	1	0
16:00:00	1076	36	52	2	0	0	34	1	3	0	0	0	14	0	1	0	0	0	2	1
16:15:00	1124	48	55	3	0	0	36	2	3	0	0	0	14	0	1	0	0	0	11	9
16:30:00	1164	40	62	7	0	0	38	2	3	0	0	0	14	0	1	0	0	0	11	0
16:45:00	1204	40	68	6	0	0	39	1	3	0	0	0	14	0	1	0	0	0	11	0
17:00:00	1248	44	73	5	0	0	39	0	3	0	0	0	14	0	1	0	0	0	11	0
17:15:00	1282	34	78	5	0	0	40	1	3	0	0	0	14	0	1	0	0	0	11	0
17:30:00	1338	56	83	5	0	0	40	0	3	0	0	0	14	0	1	0	0	0	11	0
17:45:00	1392	54	84	1	0	0	41	1	3	0	0	0	14	0	1	0	0	0	11	0

Ontario Traffic Inc.

Count Date: 1-Apr-19 Site #: 1906900092

Interval Time	Passenger Cars - West Approach						Trucks - West Approach						Heavys - West Approach						Pedestrians	
	Left		Thru		Right		Left		Thru		Right		Left		Thru		Right		West Cross	
	Cum	Incr	Cum	Incr	Cum	Incr	Cum	Incr	Cum	Incr	Cum	Incr	Cum	Incr	Cum	Incr	Cum	Incr	Cum	Incr
7:00:00	0	0	1	1	0	0	0	0	0	0	0	0	0	0	0	0	0	0	0	0
7:15:00	0	0	1	0	12	12	0	0	0	0	0	0	0	0	0	0	0	0	0	0
7:30:00	1	1	1	0	47	35	0	0	0	0	1	1	0	0	0	0	0	0	0	0
7:45:00	1	0	1	0	73	26	0	0	0	0	2	1	0	0	0	0	0	0	0	0
8:00:00	1	0	1	0	109	36	0	0	0	0	3	1	0	0	0	0	0	0	0	0
8:15:00	1	0	1	0	127	18	0	0	0	0	3	0	1	1	0	0	1	1	0	0
8:30:00	2	1	1	0	176	49	0	0	0	0	4	1	1	0	0	0	1	0	0	0
8:45:00	4	2	1	0	206	30	0	0	0	0	4	0	1	0	0	0	2	1	0	0
9:00:00	6	2	1	0	245	39	0	0	0	0	4	0	1	0	0	0	3	1	0	0
9:15:00	7	1	1	0	272	27	0	0	0	0	6	2	1	0	0	0	3	0	0	0
9:30:00	7	0	1	0	299	27	0	0	0	0	6	0	1	0	0	0	4	1	0	0
9:45:00	8	1	1	0	334	35	0	0	0	0	7	1	1	0	0	0	5	1	0	0
10:00:00	11	3	1	0	359	25	0	0	0	0	8	1	1	0	0	0	5	0	0	0
10:00:16	11	0	2	1	360	1	0	0	0	0	8	0	1	0	0	0	5	0	0	0
11:00:00	11	0	3	1	360	0	0	0	0	0	8	0	1	0	0	0	5	0	0	0
11:15:00	13	2	3	0	406	46	0	0	0	0	8	0	1	0	0	0	6	1	0	0
11:30:00	13	0	3	0	439	33	0	0	0	0	8	0	1	0	0	0	7	1	0	0
11:45:00	13	0	3	0	482	43	0	0	0	0	9	1	1	0	0	0	7	0	0	0
12:00:00	15	2	4	1	528	46	1	1	0	0	9	0	1	0	0	0	7	0	0	0
12:15:00	15	0	4	0	578	50	1	0	0	0	10	1	1	0	0	0	8	1	0	0
12:30:00	15	0	4	0	602	24	1	0	0	0	11	1	1	0	0	0	8	0	0	0
12:45:00	17	2	4	0	629	27	1	0	0	0	11	0	1	0	0	0	8	0	0	0
13:00:00	18	1	4	0	664	35	1	0	0	0	11	0	1	0	0	0	8	0	0	0
13:15:00	21	3	4	0	711	47	1	0	0	0	11	0	1	0	0	0	8	0	0	0
13:30:00	24	3	4	0	743	32	1	0	0	0	11	0	1	0	0	0	8	0	0	0
13:45:00	25	1	4	0	782	39	2	1	0	0	12	1	1	0	0	0	8	0	0	0
14:00:00	27	2	4	0	846	64	2	0	0	0	12	0	1	0	0	0	8	0	0	0
14:00:06	27	0	5	1	846	0	2	0	0	0	12	0	1	0	0	0	8	0	0	0
15:00:00	27	0	6	1	846	0	2	0	0	0	12	0	1	0	0	0	8	0	0	0
15:15:00	27	0	6	0	914	68	2	0	0	0	14	2	1	0	0	0	9	1	0	0
15:30:00	30	3	6	0	990	76	2	0	0	0	14	0	1	0	0	0	9	0	0	0
15:45:00	35	5	6	0	1063	73	2	0	0	0	15	1	1	0	0	0	9	0	0	0
16:00:00	40	5	6	0	1145	82	2	0	0	0	15	0	1	0	0	0	9	0	0	0
16:15:00	42	2	6	0	1240	95	3	1	0	0	15	0	1	0	0	0	10	1	1	1
16:30:00	45	3	6	0	1322	82	3	0	0	0	15	0	1	0	0	0	10	0	1	0
16:45:00	49	4	6	0	1404	82	3	0	0	0	15	0	1	0	0	0	10	0	1	0
17:00:00	50	1	6	0	1490	86	3	0	0	0	15	0	1	0	0	0	10	0	1	0
17:15:00	53	3	6	0	1577	87	3	0	0	0	15	0	1	0	0	0	10	0	1	0
17:30:00	56	3	6	0	1649	72	3	0	0	0	16	1	1	0	0	0	10	0	1	0
17:45:00	58	2	6	0	1747	98	3	0	0	0	16	0	1	0	0	0	10	0	1	0



Project #21-037 - City of Windsor

Intersection Count Report

Intersection: BANWELL RD & MCNORTON ST-MCHUGH ST
Municipality: Windsor
Count Date: Mar 25, 2021
Site Code: 2103700009
Count Categories: Cars, Medium Trucks + Buses, Heavy Trucks, Peds, Bicycles
Count Period: 07:00-10:00, 11:00-14:00, 15:00-18:00
Weather: Clear

Traffic Count Map

Intersection: BANWELL RD & MCNORTON ST-MCHUGH ST
 Site Code: 2103700009
 Municipality: Windsor
 Count Date: Mar 25, 2021

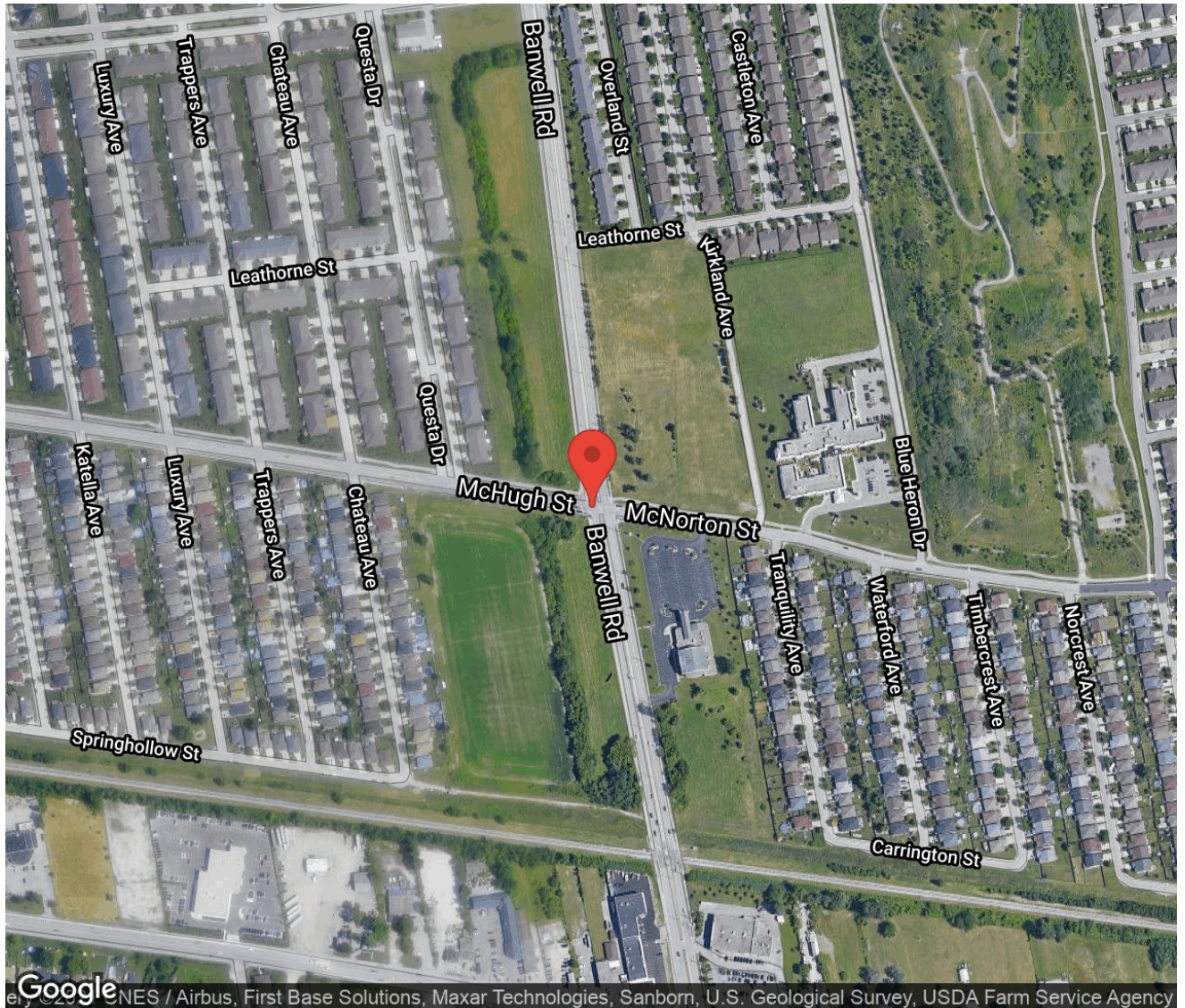



Traffic Count Summary

Intersection: BANWELL RD & MCNORTON ST-MCHUGH ST
 Site Code: 2103700009
 Municipality: Windsor
 Count Date: Mar 25, 2021

BANWELL RD - Traffic Summary

Hour	North Approach Totals						South Approach Totals						Total
	Includes Cars, Medium Trucks + Buses, Heavy Trucks, Bicycles						Includes Cars, Medium Trucks + Buses, Heavy Trucks, Bicycles						
	Left	Thru	Right	U-Turn	Total	Peds	Left	Thru	Right	U-Turn	Total	Peds	
07:00 - 08:00	32	303	13	0	348	2	39	137	46	0	222	1	570
08:00 - 09:00	37	312	24	0	373	4	82	189	75	0	346	0	719
09:00 - 10:00	36	240	26	0	302	4	68	196	93	1	358	1	660
BREAK													
11:00 - 12:00	43	257	24	0	324	21	102	277	111	0	490	2	814
12:00 - 13:00	43	296	30	0	369	7	83	274	160	1	518	4	887
13:00 - 14:00	32	263	28	0	323	4	84	310	126	2	522	0	845
BREAK													
15:00 - 16:00	46	361	29	0	436	2	117	426	200	0	743	2	1179
16:00 - 17:00	42	346	24	0	412	3	135	483	233	0	851	3	1263
17:00 - 18:00	39	276	20	0	335	3	115	442	237	0	794	0	1129
GRAND TOTAL	350	2654	218	0	3222	50	825	2734	1281	4	4844	13	8066



Traffic Count Summary

Intersection: BANWELL RD & MCNORTON ST-MCHUGH ST
 Site Code: 2103700009
 Municipality: Windsor
 Count Date: Mar 25, 2021

MCNORTON ST - Traffic Summary

Hour	East Approach Totals						West Approach Totals						Total
	Left	Thru	Right	U-Turn	Total	Peds	Left	Thru	Right	U-Turn	Total	Peds	
07:00 - 08:00	126	96	34	0	256	1	3	67	110	0	180	1	436
08:00 - 09:00	131	147	36	0	314	0	12	80	97	0	189	1	503
09:00 - 10:00	108	123	24	0	255	3	9	74	85	0	168	2	423
BREAK													
11:00 - 12:00	112	131	39	0	282	1	19	136	110	0	265	1	547
12:00 - 13:00	101	138	38	0	277	3	15	114	87	0	216	5	493
13:00 - 14:00	103	140	35	0	278	0	23	124	113	0	260	4	538
BREAK													
15:00 - 16:00	130	180	66	0	376	2	15	183	123	0	321	2	697
16:00 - 17:00	106	177	66	0	349	5	23	168	97	0	288	2	637
17:00 - 18:00	100	149	54	0	303	3	21	133	87	0	241	3	544
GRAND TOTAL	1017	1281	392	0	2690	18	140	1079	909	0	2128	21	4818



Traffic Count Data

Intersection: BANWELL RD & MCNORTON ST-MCHUGH ST
 Site Code: 2103700009
 Municipality: Windsor
 Count Date: Mar 25, 2021

North Approach - BANWELL RD

Start Time	Cars					Medium Trucks + Buses					Heavy Trucks					Bicycles					Total Peds
	←	↑	→	↻	Total	←	↑	→	↻	Total	←	↑	→	↻	Total	←	↑	→	↻	Total	
07:00	8	56	2	0	66	0	0	0	0	0	0	0	0	0	0	0	0	0	0	0	1
07:15	7	68	2	0	77	0	0	0	0	0	0	0	0	0	0	0	0	0	0	0	1
07:30	7	94	4	0	105	0	0	0	0	0	0	0	0	0	0	0	0	0	0	0	0
07:45	10	82	5	0	97	0	2	0	0	2	0	1	0	0	1	0	0	0	0	0	0
08:00	9	85	2	0	96	1	2	0	0	3	0	0	0	0	0	0	0	0	0	0	0
08:15	10	70	2	0	82	0	0	0	0	0	0	0	0	0	0	0	0	0	0	0	1
08:30	8	92	10	0	110	0	0	0	0	0	0	1	0	0	1	0	0	0	0	0	3
08:45	9	60	9	0	78	0	1	0	0	1	0	1	1	0	2	0	0	0	0	0	0
09:00	11	70	6	0	87	0	0	0	0	0	0	0	0	0	0	0	0	0	0	0	0
09:15	2	54	4	0	60	1	0	0	0	1	0	0	0	0	0	0	0	0	0	0	2
09:30	11	52	8	0	71	0	2	0	0	2	0	2	0	0	2	0	0	0	0	0	2
09:45	11	57	8	0	76	0	2	0	0	2	0	1	0	0	1	0	0	0	0	0	0
SUBTOTAL	103	840	62	0	1005	2	9	0	0	11	0	6	1	0	7	0	0	0	0	0	10



Traffic Count Data

Intersection: BANWELL RD & MCNORTON ST-MCHUGH ST
 Site Code: 2103700009
 Municipality: Windsor
 Count Date: Mar 25, 2021

North Approach - BANWELL RD

Start Time	Cars					Medium Trucks + Buses					Heavy Trucks					Bicycles					Total Peds
	←	↑	→	↻	Total	←	↑	→	↻	Total	←	↑	→	↻	Total	←	↑	→	↻	Total	
11:00	6	67	7	0	80	1	1	0	0	2	0	0	0	0	0	0	0	0	0	0	4
11:15	8	58	8	0	74	0	1	1	0	2	0	2	0	0	2	0	0	0	0	0	7
11:30	8	68	5	0	81	2	0	0	0	2	0	0	0	0	0	1	0	0	0	1	10
11:45	17	59	3	0	79	0	0	0	0	0	0	0	0	0	0	0	1	0	0	1	0
12:00	15	78	6	0	99	0	1	0	0	1	0	0	0	0	0	0	0	0	0	0	0
12:15	8	82	9	0	99	0	1	0	0	1	0	1	0	0	1	0	0	0	0	0	4
12:30	11	65	10	0	86	0	0	0	0	0	0	0	0	0	0	0	0	0	0	0	1
12:45	9	66	5	0	80	0	1	0	0	1	0	1	0	0	1	0	0	0	0	0	2
13:00	8	50	3	0	61	0	1	0	0	1	0	2	0	0	2	0	0	0	0	0	1
13:15	10	82	4	0	96	0	0	0	0	0	0	0	0	0	0	0	0	0	0	0	0
13:30	5	53	8	0	66	0	1	0	0	1	0	0	0	0	0	0	0	0	0	0	2
13:45	9	71	13	0	93	0	0	0	0	0	0	3	0	0	3	0	0	0	0	0	1
SUBTOTAL	114	799	81	0	994	3	7	1	0	11	0	9	0	0	9	1	1	0	0	2	32



Traffic Count Data

Intersection: BANWELL RD & MCNORTON ST-MCHUGH ST
 Site Code: 2103700009
 Municipality: Windsor
 Count Date: Mar 25, 2021

North Approach - BANWELL RD

Start Time	Cars					Medium Trucks + Buses					Heavy Trucks					Bicycles					Total Peds	
	←	↑	→	↻	Total	←	↑	→	↻	Total	←	↑	→	↻	Total	←	↑	→	↻	Total		
15:00	12	90	7	0	109	1	1	0	0	2	0	3	0	0	3	0	1	0	0	1	0	
15:15	7	75	8	0	90	0	2	0	0	2	0	0	0	0	0	0	0	0	0	0	0	2
15:30	15	88	8	0	111	0	1	0	0	1	0	2	0	0	2	0	0	0	0	0	0	0
15:45	10	95	6	0	111	1	1	0	0	2	0	2	0	0	2	0	0	0	0	0	0	0
16:00	10	85	4	0	99	0	1	0	0	1	0	2	0	0	2	0	2	0	0	2	2	3
16:15	10	75	5	0	90	1	1	0	0	2	0	1	0	0	1	0	0	0	0	0	0	0
16:30	10	94	12	0	116	0	2	0	0	2	0	2	0	0	2	0	1	0	0	1	1	0
16:45	11	78	3	0	92	0	0	0	0	0	0	0	0	0	0	0	2	0	0	2	2	0
17:00	12	70	7	0	89	0	0	0	0	0	0	0	0	0	0	0	0	0	0	0	0	0
17:15	12	78	2	0	92	0	0	0	0	0	0	0	0	0	0	0	0	0	0	0	0	1
17:30	12	57	5	0	74	0	0	0	0	0	0	0	0	0	0	0	0	0	0	0	0	2
17:45	3	71	6	0	80	0	0	0	0	0	0	0	0	0	0	0	0	0	0	0	0	0
SUBTOTAL	124	956	73	0	1153	3	9	0	0	12	0	12	0	0	12	0	6	0	0	6	6	8
GRAND TOTAL	341	2595	216	0	3152	8	25	1	0	34	0	27	1	0	28	1	7	0	0	8	8	50



Traffic Count Data

Intersection: BANWELL RD & MCNORTON ST-MCHUGH ST
 Site Code: 2103700009
 Municipality: Windsor
 Count Date: Mar 25, 2021

South Approach - BANWELL RD

Start Time	Cars					Medium Trucks + Buses					Heavy Trucks					Bicycles					Total Peds
	←	↑	→	↻	Total	←	↑	→	↻	Total	←	↑	→	↻	Total	←	↑	→	↻	Total	
07:00	8	23	10	0	41	1	1	0	0	2	1	0	0	0	1	0	0	0	0	0	0
07:15	11	29	11	0	51	1	5	0	0	6	0	1	0	0	1	0	0	0	0	0	0
07:30	10	28	12	0	50	1	4	0	0	5	0	1	0	0	1	0	0	0	0	0	0
07:45	6	43	12	0	61	0	2	1	0	3	0	0	0	0	0	0	0	0	0	0	1
08:00	16	51	11	0	78	0	0	2	0	2	0	1	0	0	1	0	0	0	0	0	0
08:15	23	31	15	0	69	1	3	0	0	4	0	2	0	0	2	0	0	0	0	0	0
08:30	23	49	21	0	93	1	0	0	0	1	0	2	0	0	2	0	0	0	0	0	0
08:45	16	45	25	0	86	1	4	1	0	6	1	1	0	0	2	0	0	0	0	0	0
09:00	11	52	19	0	82	0	1	0	0	1	0	1	0	0	1	0	0	0	0	0	0
09:15	19	53	28	0	100	0	1	0	0	1	0	1	0	0	1	0	0	0	0	0	0
09:30	21	43	12	0	76	1	1	0	0	2	0	1	0	0	1	0	0	0	0	0	0
09:45	16	42	33	1	92	0	0	0	0	0	0	0	0	0	0	0	0	1	0	1	1
SUBTOTAL	180	489	209	1	879	7	22	4	0	33	2	11	0	0	13	0	0	1	0	1	2



Traffic Count Data

Intersection: BANWELL RD & MCNORTON ST-MCHUGH ST
 Site Code: 2103700009
 Municipality: Windsor
 Count Date: Mar 25, 2021

South Approach - BANWELL RD

Start Time	Cars					Medium Trucks + Buses					Heavy Trucks					Bicycles					Total Peds
	←	↑	→	↻	Total	←	↑	→	↻	Total	←	↑	→	↻	Total	←	↑	→	↻	Total	
11:00	17	64	29	0	110	0	2	0	0	2	0	3	0	0	3	0	0	0	0	0	0
11:15	21	54	28	0	103	0	1	1	0	2	3	0	0	0	3	0	0	0	0	0	0
11:30	30	80	29	0	139	0	0	0	0	0	0	0	0	0	0	0	0	0	0	0	1
11:45	30	70	24	0	124	0	0	0	0	0	1	2	0	0	3	0	1	0	0	1	1
12:00	19	58	38	0	115	0	1	0	0	1	0	0	0	0	0	1	1	0	0	2	0
12:15	23	81	47	1	152	0	2	0	0	2	0	0	1	0	1	0	0	0	0	0	1
12:30	20	73	27	0	120	0	1	0	0	1	0	1	0	0	1	0	0	0	0	0	0
12:45	20	55	47	0	122	0	0	0	0	0	0	1	0	0	1	0	0	0	0	0	3
13:00	21	73	28	0	122	0	2	0	0	2	1	1	0	0	2	0	0	0	0	0	0
13:15	17	69	31	1	118	0	1	0	0	1	0	1	0	0	1	0	0	0	0	0	0
13:30	26	80	32	1	139	0	1	0	0	1	0	0	0	0	0	0	0	0	0	0	0
13:45	19	80	34	0	133	0	1	1	0	2	0	1	0	0	1	0	0	0	0	0	0
SUBTOTAL	263	837	394	3	1497	0	12	2	0	14	5	10	1	0	16	1	2	0	0	3	6



Traffic Count Data

Intersection: BANWELL RD & MCNORTON ST-MCHUGH ST
 Site Code: 2103700009
 Municipality: Windsor
 Count Date: Mar 25, 2021

South Approach - BANWELL RD

Start Time	Cars					Medium Trucks + Buses					Heavy Trucks					Bicycles					Total Peds
	←	↑	→	↻	Total	←	↑	→	↻	Total	←	↑	→	↻	Total	←	↑	→	↻	Total	
15:00	29	106	39	0	174	0	1	2	0	3	0	1	0	0	1	0	0	0	0	0	0
15:15	21	78	51	0	150	0	1	0	0	1	0	1	0	0	1	0	2	0	0	2	1
15:30	32	129	47	0	208	1	0	0	0	1	0	0	0	0	0	0	0	1	0	1	0
15:45	34	102	58	0	194	0	1	2	0	3	0	3	0	0	3	0	1	0	0	1	1
16:00	31	123	53	0	207	1	1	0	0	2	0	0	0	0	0	0	1	0	0	1	0
16:15	39	108	47	0	194	0	0	0	0	0	0	0	0	0	0	0	1	0	0	1	1
16:30	34	124	73	0	231	0	1	0	0	1	0	0	0	0	0	0	0	0	0	0	2
16:45	30	124	60	0	214	0	0	0	0	0	0	0	0	0	0	0	0	0	0	0	0
17:00	37	113	69	0	219	0	0	0	0	0	0	0	0	0	0	0	0	0	0	0	0
17:15	28	127	61	0	216	0	1	0	0	1	0	0	0	0	0	0	1	0	0	1	0
17:30	28	101	51	0	180	0	0	0	0	0	0	0	0	0	0	0	0	0	0	0	0
17:45	21	99	56	0	176	1	0	0	0	1	0	0	0	0	0	0	0	0	0	0	0
SUBTOTAL	364	1334	665	0	2363	3	6	4	0	13	0	5	0	0	5	0	6	1	0	7	5
GRAND TOTAL	807	2660	1268	4	4739	10	40	10	0	60	7	26	1	0	34	1	8	2	0	11	13



Traffic Count Data

Intersection: BANWELL RD & MCNORTON ST-MCHUGH ST
 Site Code: 2103700009
 Municipality: Windsor
 Count Date: Mar 25, 2021

East Approach - MCNORTON ST

Start Time	Cars					Medium Trucks + Buses					Heavy Trucks					Bicycles					Total Peds
	←	↑	→	↻	Total	←	↑	→	↻	Total	←	↑	→	↻	Total	←	↑	→	↻	Total	
07:00	21	19	10	0	50	0	0	1	0	1	0	0	0	0	0	0	0	0	0	0	0
07:15	29	13	5	0	47	0	1	0	0	1	0	0	0	0	0	0	0	0	0	0	0
07:30	32	26	6	0	64	0	2	1	0	3	0	0	0	0	0	0	0	0	0	0	0
07:45	43	35	10	0	88	1	0	1	0	2	0	0	0	0	0	0	0	0	0	0	1
08:00	26	22	9	0	57	2	0	1	0	3	0	0	0	0	0	0	0	0	0	0	0
08:15	37	34	8	0	79	1	0	0	0	1	0	0	0	0	0	0	0	0	0	0	0
08:30	28	47	7	0	82	2	0	3	0	5	0	0	0	0	0	0	1	0	0	1	0
08:45	35	41	8	0	84	0	1	0	0	1	0	1	0	0	1	0	0	0	0	0	0
09:00	37	29	4	0	70	0	0	0	0	0	0	0	0	0	0	0	0	0	0	0	1
09:15	27	28	8	0	63	0	0	0	0	0	0	0	0	0	0	0	0	0	0	0	1
09:30	24	39	8	0	71	0	1	0	0	1	0	0	0	0	0	0	0	0	0	0	1
09:45	20	26	4	0	50	0	0	0	0	0	0	0	0	0	0	0	0	0	0	0	0
SUBTOTAL	359	359	87	0	805	6	5	7	0	18	0	1	0	0	1	0	1	0	0	1	4



Traffic Count Data

Intersection: BANWELL RD & MCNORTON ST-MCHUGH ST
 Site Code: 2103700009
 Municipality: Windsor
 Count Date: Mar 25, 2021

East Approach - MCNORTON ST

Start Time	Cars					Medium Trucks + Buses					Heavy Trucks					Bicycles					Total Peds
	←	↑	→	↻	Total	←	↑	→	↻	Total	←	↑	→	↻	Total	←	↑	→	↻	Total	
11:00	22	30	7	0	59	0	0	0	0	0	1	0	0	0	1	0	0	0	0	0	0
11:15	31	36	12	0	79	0	1	0	0	1	0	0	0	0	0	0	0	0	0	0	1
11:30	37	40	5	0	82	0	0	0	0	0	0	0	0	0	0	0	0	0	0	0	0
11:45	21	24	15	0	60	0	0	0	0	0	0	0	0	0	0	0	0	0	0	0	0
12:00	28	44	11	0	83	0	0	0	0	0	0	0	0	0	0	0	2	0	0	2	1
12:15	23	32	6	0	61	0	1	0	0	1	0	1	0	0	1	0	0	0	0	0	0
12:30	30	28	16	0	74	0	0	0	0	0	0	0	0	0	0	0	1	0	0	1	0
12:45	19	29	5	0	53	1	0	0	0	1	0	0	0	0	0	0	0	0	0	0	2
13:00	22	38	14	0	74	1	0	0	0	1	0	0	0	0	0	0	1	0	0	1	0
13:15	26	35	9	0	70	0	0	1	0	1	0	0	0	0	0	0	1	0	0	1	0
13:30	31	33	6	0	70	0	1	0	0	1	0	0	0	0	0	0	2	0	0	2	0
13:45	23	27	5	0	55	0	2	0	0	2	0	0	0	0	0	0	0	0	0	0	0
SUBTOTAL	313	396	111	0	820	2	5	1	0	8	1	1	0	0	2	0	7	0	0	7	4



Traffic Count Data

Intersection: BANWELL RD & MCNORTON ST-MCHUGH ST
 Site Code: 2103700009
 Municipality: Windsor
 Count Date: Mar 25, 2021

East Approach - MCNORTON ST

Start Time	Cars					Medium Trucks + Buses					Heavy Trucks					Bicycles					Total Peds
	←	↑	→	↻	Total	←	↑	→	↻	Total	←	↑	→	↻	Total	←	↑	→	↻	Total	
15:00	42	44	10	0	96	2	1	0	0	3	0	0	0	0	0	0	6	0	0	6	0
15:15	37	49	19	0	105	1	0	0	0	1	0	0	0	0	0	0	0	0	0	0	0
15:30	21	37	18	0	76	0	0	0	0	0	0	0	0	0	0	0	0	0	0	0	1
15:45	25	42	17	0	84	2	1	1	0	4	0	0	0	0	0	0	0	1	0	1	1
16:00	33	54	23	0	110	0	0	0	0	0	0	0	0	0	0	0	0	0	0	0	3
16:15	23	32	9	0	64	1	1	0	0	2	0	0	0	0	0	0	0	0	0	0	0
16:30	25	39	14	0	78	0	0	0	0	0	0	0	0	0	0	0	1	1	0	2	2
16:45	24	48	19	0	91	0	0	0	0	0	0	0	0	0	0	0	2	0	0	2	0
17:00	16	33	13	0	62	0	0	0	0	0	0	0	0	0	0	0	1	0	0	1	3
17:15	32	44	23	0	99	1	0	0	0	1	0	0	0	0	0	0	1	0	0	1	0
17:30	31	40	6	0	77	0	0	0	0	0	0	0	0	0	0	0	0	0	0	0	0
17:45	20	29	12	0	61	0	0	0	0	0	0	0	0	0	0	0	1	0	0	1	0
SUBTOTAL	329	491	183	0	1003	7	3	1	0	11	0	0	0	0	0	0	12	2	0	14	10
GRAND TOTAL	1001	1246	381	0	2628	15	13	9	0	37	1	2	0	0	3	0	20	2	0	22	18



Traffic Count Data

Intersection: BANWELL RD & MCNORTON ST-MCHUGH ST
 Site Code: 2103700009
 Municipality: Windsor
 Count Date: Mar 25, 2021

West Approach - MCHUGH ST

Start Time	Cars					Medium Trucks + Buses					Heavy Trucks					Bicycles					Total Peds	
	←	↑	→	↻	Total	←	↑	→	↻	Total	←	↑	→	↻	Total	←	↑	→	↻	Total		
07:00	1	15	12	0	28	1	0	0	0	1	0	0	0	0	0	0	0	0	0	0	0	0
07:15	0	12	34	0	46	0	1	0	0	1	0	0	0	0	0	0	0	0	0	0	0	0
07:30	0	16	24	0	40	0	0	0	0	0	0	0	0	0	0	0	0	0	0	0	0	0
07:45	1	21	40	0	62	0	2	0	0	2	0	0	0	0	0	0	0	0	0	0	0	1
08:00	0	9	21	0	30	0	1	1	0	2	0	0	0	0	0	0	0	0	0	0	0	0
08:15	1	19	23	0	43	0	2	0	0	2	0	0	0	0	0	0	0	0	0	0	0	1
08:30	5	25	24	0	54	0	0	0	0	0	0	0	0	0	0	0	0	0	0	0	0	0
08:45	4	23	26	0	53	2	1	2	0	5	0	0	0	0	0	0	0	0	0	0	0	0
09:00	1	14	25	0	40	0	0	0	0	0	0	0	0	0	0	0	0	0	0	0	0	0
09:15	3	19	18	0	40	0	1	0	0	1	0	0	0	0	0	0	0	0	0	0	0	0
09:30	3	12	21	0	36	0	0	1	0	1	0	0	0	0	0	0	0	0	0	0	0	0
09:45	2	26	20	0	48	0	1	0	0	1	0	0	0	0	0	0	1	0	0	1	1	2
SUBTOTAL	21	211	288	0	520	3	9	4	0	16	0	0	0	0	0	0	1	0	0	1	1	4



Traffic Count Data

Intersection: BANWELL RD & MCNORTON ST-MCHUGH ST
 Site Code: 2103700009
 Municipality: Windsor
 Count Date: Mar 25, 2021

West Approach - MCHUGH ST

Start Time	Cars					Medium Trucks + Buses					Heavy Trucks					Bicycles					Total Peds
	←	↑	→	↻	Total	←	↑	→	↻	Total	←	↑	→	↻	Total	←	↑	→	↻	Total	
11:00	3	23	24	0	50	0	0	0	0	0	0	0	0	0	0	0	1	0	0	1	0
11:15	7	42	30	0	79	1	2	1	0	4	0	0	0	0	0	0	0	0	0	0	0
11:30	4	39	28	0	71	0	0	0	0	0	0	0	1	0	1	0	1	0	0	1	0
11:45	4	27	26	0	57	0	0	0	0	0	0	0	0	0	0	0	1	0	0	1	1
12:00	3	24	26	0	53	0	0	0	0	0	0	0	0	0	0	0	0	0	0	0	0
12:15	6	30	18	0	54	0	0	0	0	0	0	0	0	0	0	0	0	0	0	0	3
12:30	3	28	22	0	53	0	0	1	0	1	0	0	0	0	0	0	0	0	0	0	0
12:45	2	32	20	0	54	1	0	0	0	1	0	0	0	0	0	0	0	0	0	0	2
13:00	6	28	26	0	60	0	0	1	0	1	0	0	0	0	0	0	2	0	0	2	2
13:15	6	26	30	0	62	0	0	0	0	0	0	0	0	0	0	0	1	0	0	1	2
13:30	6	30	27	0	63	0	0	0	0	0	0	0	0	0	0	1	1	2	0	4	0
13:45	4	36	27	0	67	0	0	0	0	0	0	0	0	0	0	0	0	0	0	0	0
SUBTOTAL	54	365	304	0	723	2	2	3	0	7	0	0	1	0	1	1	7	2	0	10	10



Traffic Count Data

Intersection: BANWELL RD & MCNORTON ST-MCHUGH ST
 Site Code: 2103700009
 Municipality: Windsor
 Count Date: Mar 25, 2021

West Approach - MCHUGH ST

Start Time	Cars					Medium Trucks + Buses					Heavy Trucks					Bicycles					Total Peds
	←	↑	→	↻	Total	←	↑	→	↻	Total	←	↑	→	↻	Total	←	↑	→	↻	Total	
15:00	5	47	41	0	93	0	1	1	0	2	0	0	0	0	0	0	0	0	0	0	1
15:15	4	52	35	0	91	0	0	0	0	0	0	0	0	0	0	0	0	0	0	0	0
15:30	3	39	27	0	69	1	2	0	0	3	0	0	0	0	0	0	0	0	0	0	0
15:45	2	40	17	0	59	0	1	1	0	2	0	0	0	0	0	0	1	1	0	2	1
16:00	9	38	24	0	71	0	0	0	0	0	0	0	0	0	0	0	0	0	0	0	1
16:15	8	32	24	0	64	0	1	0	0	1	0	0	0	0	0	0	0	0	0	0	0
16:30	4	44	21	0	69	0	0	0	0	0	0	0	0	0	0	0	0	0	0	0	0
16:45	2	49	28	0	79	0	1	0	0	1	0	0	0	0	0	0	3	0	0	3	1
17:00	7	44	28	0	79	0	0	0	0	0	0	0	0	0	0	0	0	0	0	0	2
17:15	6	42	15	0	63	1	0	0	0	1	0	0	0	0	0	0	0	0	0	0	1
17:30	3	21	22	0	46	0	0	0	0	0	0	0	0	0	0	0	0	0	0	0	0
17:45	3	24	22	0	49	0	0	0	0	0	0	0	0	0	0	1	2	0	0	3	0
SUBTOTAL	56	472	304	0	832	2	6	2	0	10	0	0	0	0	0	1	6	1	0	8	7
GRAND TOTAL	131	1048	896	0	2075	7	17	9	0	33	0	0	1	0	1	2	14	3	0	19	21

Peak Hour Diagram

Specified Period

From: 07:00:00
To: 10:00:00

One Hour Peak

From: 08:15:00
To: 09:15:00

Intersection: BANWELL RD & MCNORTON ST-MCHUGH ST
Site Code: 2103700009
Count Date: Mar 25, 2021

Weather conditions: Clear

**** Signalized Intersection ****

Major Road: BANWELL RD runs N/S

North Approach

	Out	In	Total
	357	215	572
MTB	1	13	14
HT	3	6	9
	0	0	0
Totals	361	234	595

BANWELL RD

	0	0	0	0
HT	1	2	0	0
MTB	0	1	0	0
	27	292	38	0
Totals	28	295	38	0

East Approach

	Out	In	Total
	315	199	514
MTB	7	4	11
HT	1	0	1
	1	0	1
Totals	324	203	527

MCHUGH ST

	HT	MTB		Totals
0	0	0	0	0
0	0	2	11	13
0	0	3	81	84
0	0	2	98	100

Peds: 4

Peds: 1



Peds: 1

Peds: 0

MCNORTON ST

Totals		MTB	HT	
0	0	0	0	0
30	27	3	0	0
154	151	1	1	1
140	137	3	0	0

West Approach

	Out	In	Total
	190	251	441
MTB	7	4	11
HT	0	3	3
	0	1	1
Totals	197	259	456

Totals				
77	191	81	0	
	73	177	80	0
MTB	3	8	1	0
HT	1	6	0	0
	0	0	0	0

BANWELL RD

South Approach

Out	In	Total	
	330	527	857
MTB	12	6	18
HT	7	2	9
	0	0	0
Totals	349	535	884

- Cars

MTB - Medium Trucks + Buses HT - Heavy Trucks

- Bicycles

Comments



Peak Hour Summary

Intersection: BANWELL RD & MCNORTON ST-MCHUGH ST
 Site Code: 2103700009
 Count Date: Mar 25, 2021
 Period: 07:00 - 10:00

Peak Hour Data (08:15 - 09:15)

Start Time	North Approach BANWELL RD						South Approach BANWELL RD						East Approach MCNORTON ST						West Approach MCHUGH ST						Total Vehicles
	←	↑	→	↻	Peds	Total	←	↑	→	↻	Peds	Total	←	↑	→	↻	Peds	Total	←	↑	→	↻	Peds	Total	
08:15	10	70	2	0	1	82	24	36	15	0	0	75	38	34	8	0	0	80	1	21	23	0	1	45	282
08:30	8	93	10	0	3	111	24	51	21	0	0	96	30	48	10	0	0	88	5	25	24	0	0	54	349
08:45	9	62	10	0	0	81	18	50	26	0	0	94	35	43	8	0	0	86	6	24	28	0	0	58	319
09:00	11	70	6	0	0	87	11	54	19	0	0	84	37	29	4	0	1	70	1	14	25	0	0	40	281
Grand Total	38	295	28	0	4	361	77	191	81	0	0	349	140	154	30	0	1	324	13	84	100	0	1	197	1231
Approach %	10.5	81.7	7.8	0	-	-	22.1	54.7	23.2	0	-	-	43.2	47.5	9.3	0	-	-	6.6	42.6	50.8	0	-	-	
Totals %	3.1	24	2.3	0	29.3	6.3	15.5	6.6	0	28.4	11.4	12.5	2.4	0	26.3	1.1	6.8	8.1	0	16					
PHF	0.86	0.79	0.7	0	0.81	0.8	0.88	0.78	0	0.91	0.92	0.8	0.75	0	0.92	0.54	0.84	0.89	0	0.85	0.88				
Cars	38	292	27	0	357	73	177	80	0	330	137	151	27	0	315	11	81	98	0	190	1192				
% Cars	100	99	96.4	0	98.9	94.8	92.7	98.8	0	94.6	97.9	98.1	90	0	97.2	84.6	96.4	98	0	96.4	96.8				
Medium Trucks + Buses	0	1	0	0	1	3	8	1	0	12	3	1	3	0	7	2	3	2	0	7	27				
% Medium Trucks + Buses	0	0.3	0	0	0.3	3.9	4.2	1.2	0	3.4	2.1	0.6	10	0	2.2	15.4	3.6	2	0	3.6	2.2				
Heavy Trucks	0	2	1	0	3	1	6	0	0	7	0	1	0	0	1	0	0	0	0	0	11				
% Heavy Trucks	0	0.7	3.6	0	0.8	1.3	3.1	0	0	2	0	0.6	0	0	0.3	0	0	0	0	0	0.9				
Bicycles	0	0	0	0	0	0	0	0	0	0	0	1	0	0	1	0	0	0	0	0	1				
% Bicycles	0	0	0	0	0	0	0	0	0	0	0	0.6	0	0	0.3	0	0	0	0	0	0.1				
Peds					4	-				0	-					1	-					1	-	6	
% Peds					66.7	-				0	-					16.7	-					16.7	-		

Peak Hour Diagram

Specified Period

From: 11:00:00
To: 14:00:00

One Hour Peak

From: 11:30:00
To: 12:30:00

Intersection: BANWELL RD & MCNORTON ST-MCHUGH ST
Site Code: 2103700009
Count Date: Mar 25, 2021

Weather conditions: Clear

**** Signalized Intersection ****

Major Road: BANWELL RD runs N/S

North Approach

	Out	In	Total
	358	343	701
MTB	4	3	7
HT	1	2	3
	2	2	4
Totals	365	350	715

BANWELL RD

	0	1	1	0
HT	0	1	0	0
MTB	0	2	2	0
	23	287	48	0
Totals	23	291	51	0

East Approach

	Out	In	Total
	286	306	592
MTB	1	2	3
HT	1	1	2
	2	3	5
Totals	290	312	602

MCHUGH ST

	HT	MTB		Totals
0	0	0	0	0
0	0	0	17	17
2	0	0	120	122
0	1	0	98	99

Peds: 14



MCNORTON ST

Totals		MTB	HT	
0	0	0	0	0
37	37	0	0	0
144	140	1	1	2
109	109	0	0	0

West Approach

	Out	In	Total
	235	265	500
MTB	0	1	1
HT	1	2	3
	2	3	5
Totals	238	271	509

Totals	104	296	139	1
	102	289	138	1
MTB	0	3	0	0
HT	1	2	1	0
	1	2	0	0

BANWELL RD

South Approach

	Out	In	Total
	530	495	1025
MTB	3	2	5
HT	4	2	6
	3	1	4
Totals	540	500	1040

- Cars

MTB - Medium Trucks + Buses HT - Heavy Trucks

- Bicycles

Comments

Peak Hour Summary

Intersection: BANWELL RD & MCNORTON ST-MCHUGH ST
 Site Code: 2103700009
 Count Date: Mar 25, 2021
 Period: 11:00 - 14:00

Peak Hour Data (11:30 - 12:30)

Start Time	North Approach BANWELL RD						South Approach BANWELL RD						East Approach MCNORTON ST						West Approach MCHUGH ST						Total Vehic es
	←	↑	→	↻	Peds	Total	←	↑	→	↻	Peds	Total	←	↑	→	↻	Peds	Total	←	↑	→	↻	Peds	Total	
11:30	11	68	5	0	10	84	30	80	29	0	1	139	37	40	5	0	0	82	4	40	29	0	0	73	378
11:45	17	60	3	0	0	80	31	73	24	0	1	128	21	24	15	0	0	60	4	28	26	0	1	58	326
12:00	15	79	6	0	0	100	20	60	38	0	0	118	28	46	11	0	1	85	3	24	26	0	0	53	356
12:15	8	84	9	0	4	101	23	83	48	1	1	155	23	34	6	0	0	63	6	30	18	0	3	54	373
Grand Total	51	291	23	0	14	365	104	296	139	1	3	540	109	144	37	0	1	290	17	122	99	0	4	238	1433
Approach %	14	79.7	6.3	0	-	-	19.3	54.8	25.7	0.2	-	-	37.6	49.7	12.8	0	-	-	7.1	51.3	41.6	0	-	-	-
Totals %	3.6	20.3	1.6	0	25.5	37.7	7.3	20.7	9.7	0.1	37.7	7.6	10	2.6	0	20.2	1.2	8.5	6.9	0	16.6				
PHF	0.75	0.87	0.64	0	0.9	0.87	0.84	0.89	0.72	0.25	0.87	0.74	0.78	0.62	0	0.85	0.71	0.76	0.85	0	0.82	0.95			
Cars	48	287	23	0	358	530	102	289	138	1	530	109	140	37	0	286	17	120	98	0	235	1409			
% Cars	94.1	98.6	100	0	98.1	98.1	98.1	97.6	99.3	100	98.1	100	97.2	100	0	98.6	100	98.4	99	0	98.7	98.3			
Medium Trucks + Buses	2	2	0	0	4	3	0	3	0	0	3	0	1	0	0	1	0	0	0	0	0	0	0	0	8
% Medium Trucks + Buses	3.9	0.7	0	0	1.1	0.6	0	1	0	0	0.6	0	0.7	0	0	0.3	0	0	0	0	0	0	0	0	0.6
Heavy Trucks	0	1	0	0	1	4	1	2	1	0	4	0	1	0	0	1	0	0	1	0	1	0	1	1	7
% Heavy Trucks	0	0.3	0	0	0.3	0.7	1	0.7	0.7	0	0.7	0	0.7	0	0	0.3	0	0	1	0	0.4	0	0.4	0.5	0.5
Bicycles	1	1	0	0	2	3	1	2	0	0	3	0	2	0	0	2	0	2	0	0	0	0	2	2	9
% Bicycles	2	0.3	0	0	0.5	0.6	1	0.7	0	0	0.6	0	1.4	0	0	0.7	0	1.6	0	0	0	0.8	0.8	0.6	0.6
Peds					14	-					3	-				1	-				4	-		4	22
% Peds					63.6	-					13.6	-				4.5	-				18.2	-		18.2	-

Peak Hour Diagram

Specified Period

From: 15:00:00
To: 18:00:00

One Hour Peak

From: 16:30:00
To: 17:30:00

Intersection: BANWELL RD & MCNORTON ST-MCHUGH ST
Site Code: 2103700009
Count Date: Mar 25, 2021

Weather conditions: Clear

**** Signalized Intersection ****

Major Road: BANWELL RD runs N/S

North Approach

	Out	In	Total
	389	576	965
MTB	2	3	5
HT	2	0	2
	3	2	5
Totals	396	581	977

BANWELL RD

	0	3	0	0
HT	0	2	0	0
MTB	0	2	0	0
	24	320	45	0
Totals	24	327	45	0

East Approach

	Out	In	Total
	330	487	817
MTB	1	1	2
HT	0	0	0
	6	3	9
Totals	337	491	828

MCHUGH ST

	HT	MTB		Totals
0	0	0	0	0
0	0	1	19	20
3	0	1	179	183
0	0	0	92	92

Peds: 1



MCNORTON ST

Totals		MTB	HT	
0	0	0	0	0
70	69	0	0	1
169	164	0	0	5
98	97	1	0	0

Peds: 2

West Approach

	Out	In	Total
	290	317	607
MTB	2	0	2
HT	0	0	0
	3	5	8
Totals	295	322	617

Totals	129	491	263	0
	129	488	263	0
MTB	0	2	0	0
HT	0	0	0	0
	0	1	0	0

BANWELL RD

South Approach

	Out	In	Total
	880	509	1389
MTB	2	3	5
HT	0	2	2
	1	3	4
Totals	883	517	1400

- Cars

MTB - Medium Trucks + Buses HT - Heavy Trucks

- Bicycles

Comments



Peak Hour Summary

Intersection: BANWELL RD & MCNORTON ST-MCHUGH ST
 Site Code: 2103700009
 Count Date: Mar 25, 2021
 Period: 15:00 - 18:00

Peak Hour Data (16:30 - 17:30)

Start Time	North Approach BANWELL RD						South Approach BANWELL RD						East Approach MCNORTON ST						West Approach MCHUGH ST						Total Vehic es
	←	↑	→	↻	Peds	Total	←	↑	→	↻	Peds	Total	←	↑	→	↻	Peds	Total	←	↑	→	↻	Peds	Total	
16:30	10	99	12	0	0	121	34	125	73	0	2	232	25	40	15	0	2	80	4	44	21	0	0	69	502
16:45	11	80	3	0	0	94	30	124	60	0	0	214	24	50	19	0	0	93	2	53	28	0	1	83	484
17:00	12	70	7	0	0	89	37	113	69	0	0	219	16	34	13	0	3	63	7	44	28	0	2	79	450
17:15	12	78	2	0	1	92	28	129	61	0	0	218	33	45	23	0	0	101	7	42	15	0	1	64	475
Grand Total	45	327	24	0	1	396	129	491	263	0	2	883	98	169	70	0	5	337	20	183	92	0	4	295	1911
Approach %	11.4	82.6	6.1	0	-	-	14.6	55.6	29.8	0	-	-	29.1	50.1	20.8	0	-	-	6.8	62	31.2	0	-	-	-
Totals %	2.4	17.1	1.3	0	20.7	-	6.8	25.7	13.8	0	46.2	-	5.1	8.8	3.7	0	17.6	-	1	9.6	4.8	0	15.4	-	-
PHF	0.94	0.83	0.5	0	0.82	0.87	0.95	0.9	0	0.95	0.74	0.85	0.76	0	0.83	0.71	0.86	0.82	0	0.89	0.95	0.89	0.95	0.95	
Cars	45	320	24	0	389	129	488	263	0	880	97	164	69	0	330	19	179	92	0	290	1889				
% Cars	100	97.9	100	0	98.2	100	99.4	100	0	99.7	99	97	98.6	0	97.9	95	97.8	100	0	98.3	98.8				
Medium Trucks + Buses	0	2	0	0	2	0	2	0	0	2	1	0	0	0	1	1	1	0	0	2	7				
% Medium Trucks + Buses	0	0.6	0	0	0.5	0	0.4	0	0	0.2	1	0	0	0	0.3	5	0.5	0	0	0.7	0.4				
Heavy Trucks	0	2	0	0	2	0	0	0	0	0	0	0	0	0	0	0	0	0	0	0	2				
% Heavy Trucks	0	0.6	0	0	0.5	0	0	0	0	0	0	0	0	0	0	0	0	0	0	0	0.1				
Bicycles	0	3	0	0	3	0	1	0	0	1	0	5	1	0	6	0	3	0	0	3	13				
% Bicycles	0	0.9	0	0	0.8	0	0.2	0	0	0.1	0	3	1.4	0	1.8	0	1.6	0	0	1	0.7				
Peds					1	-				2	-				5	-				4	-	12			
% Peds					8.3	-				16.7	-				41.7	-				33.3	-				

Appendix C

Level of Service (LOS) Definitions

LEVEL OF SERVICE¹

Level of Service (LOS) is defined as a qualitative measure describing operational conditions within a traffic stream, and their perception by motorists and/or passengers. This concept was introduced in the 1965 *Highway Capacity Manual* as a criteria for interrupted flow conditions. The 2000 *Highway Capacity Manual* changed the basis for measuring Level of Service at intersections to control delay².

Six Levels of Service are defined with LOS A representing the best operating conditions, and LOS F the worst (briefly described below). It should be noted that there is often significant variability in the amount of delay experienced by individual drivers.

- LOS A:** This Level of Service describes the highest quality of traffic flow and is referred to as free flow. The approach appears open, turning movements are easily made and drivers have freedom of operation. Control delay is less than 10 seconds/vehicle.
- LOS B:** This Level of Service is referred to as a stable flow. Drivers feel somewhat restricted and occasionally may have to wait to complete the minor movement. Control delay is 10-15 seconds/vehicle for unsignalized intersections and 10-20 seconds/vehicle for signalized intersections.
- LOS C:** At this level, the operation is stable. Drivers feel more restricted and may have to wait, with queues developing for short periods. Control delay is 15-25 seconds/vehicle at unsignalized intersections and 20-35 seconds/vehicle at signalized intersections.
- LOS D:** At this level, traffic is approaching unstable flow. The motorist experiences increasing restriction and instability of flow. There are substantial delays to approaching vehicles during short peaks within the peak period, but there are enough gaps to lower demand to permit occasional clearance of developing queues and prevent excessive back-ups. Control delay is 25-35 seconds/vehicle at unsignalized intersections and 35-55 seconds/vehicle at signalized intersections.
- LOS E:** At this level capacity occurs. Long queues of vehicles exist and delays to vehicles may extend. Control delay is 35-50 seconds/vehicle at unsignalized intersections and 55-80 seconds/vehicle at signalized intersections.
- LOS F:** At this Level of Service, the intersection has failed. Capacity of the intersection has been exceeded. Control delay exceeds 50 seconds/vehicle at unsignalized intersections and exceeds 80 seconds/vehicle at signalized intersections.

¹

Transportation Research Board: Highway Capacity Manual 1965, 2000

²

Control delay is defined as the component of delay that results when a control signal causes a lane group to reduce speed or to stop; it is measured by comparison with the uncontrolled condition.

Appendix D

Synchro Analysis Worksheets

HCM Unsignalized Intersection Capacity Analysis
101: Wyandotte St. & Florence Ave.

















AM Peak Hour
2022 Existing Conditions



Movement	EBL	EBT	WBT	WBR	SBL	SBR
Lane Configurations						
Traffic Volume (veh/h)	10	290	315	0	10	25
Future Volume (Veh/h)	10	290	315	0	10	25
Sign Control		Free	Free		Stop	
Grade		0%	0%		0%	
Peak Hour Factor	0.92	0.92	0.92	0.92	0.92	0.92
Hourly flow rate (vph)	11	315	342	0	11	27
Pedestrians						
Lane Width (m)						
Walking Speed (m/s)						
Percent Blockage						
Right turn flare (veh)						
Median type		None	None			
Median storage (veh)						
Upstream signal (m)						
pX, platoon unblocked						
vC, conflicting volume	342				679	342
vC1, stage 1 conf vol						
vC2, stage 2 conf vol						
vCu, unblocked vol	342				679	342
tC, single (s)	4.1				6.4	6.2
tC, 2 stage (s)						
tF (s)	2.2				3.5	3.3
p0 queue free %	99				97	96
cM capacity (veh/h)	1217				413	701
Direction, Lane #	EB 1	EB 2	WB 1	SB 1		
Volume Total	11	315	342	38		
Volume Left	11	0	0	11		
Volume Right	0	0	0	27		
cSH	1217	1700	1700	583		
Volume to Capacity	0.01	0.19	0.20	0.07		
Queue Length 95th (m)	0.2	0.0	0.0	1.7		
Control Delay (s)	8.0	0.0	0.0	11.6		
Lane LOS	A			B		
Approach Delay (s)	0.3		0.0	11.6		
Approach LOS				B		
Intersection Summary						
Average Delay			0.7			
Intersection Capacity Utilization			26.6%		ICU Level of Service	A
Analysis Period (min)			15			

















HCM Unsignalized Intersection Capacity Analysis
102: Clover Ave. & Wyandotte St.

AM Peak Hour
2022 Existing Conditions

												
Movement	EBL	EBT	EBR	WBL	WBT	WBR	NBL	NBT	NBR	SBL	SBT	SBR
Lane Configurations												
Traffic Volume (veh/h)	5	290	0	0	300	10	0	0	0	10	0	5
Future Volume (Veh/h)	5	290	0	0	300	10	0	0	0	10	0	5
Sign Control		Free			Free			Stop			Stop	
Grade		0%			0%			0%			0%	
Peak Hour Factor	0.92	0.92	0.92	0.92	0.92	0.92	0.92	0.92	0.92	0.92	0.92	0.92
Hourly flow rate (vph)	5	315	0	0	326	11	0	0	0	11	0	5
Pedestrians												
Lane Width (m)												
Walking Speed (m/s)												
Percent Blockage												
Right turn flare (veh)												
Median type		None			None							
Median storage veh												
Upstream signal (m)												
pX, platoon unblocked												
vC, conflicting volume	337			315			662	662	315	656	656	332
vC1, stage 1 conf vol												
vC2, stage 2 conf vol												
vCu, unblocked vol	337			315			662	662	315	656	656	332
tC, single (s)	4.1			4.1			7.1	6.5	6.2	7.1	6.5	6.2
tC, 2 stage (s)												
tF (s)	2.2			2.2			3.5	4.0	3.3	3.5	4.0	3.3
p0 queue free %	100			100			100	100	100	97	100	99
cM capacity (veh/h)	1222			1245			372	381	725	377	383	710
Direction, Lane #	EB 1	WB 1	NB 1	SB 1								
Volume Total	320	337	0	16								
Volume Left	5	0	0	11								
Volume Right	0	11	0	5								
cSH	1222	1245	1700	442								
Volume to Capacity	0.00	0.00	0.00	0.04								
Queue Length 95th (m)	0.1	0.0	0.0	0.9								
Control Delay (s)	0.2	0.0	0.0	13.5								
Lane LOS	A		A	B								
Approach Delay (s)	0.2	0.0	0.0	13.5								
Approach LOS			A	B								
Intersection Summary												
Average Delay			0.4									
Intersection Capacity Utilization			29.3%		ICU Level of Service				A			
Analysis Period (min)			15									

















HCM Unsignalized Intersection Capacity Analysis
 103: McHugh Park Driveway/Florence Ave. & McHugh St.

AM Peak Hour
 2022 Existing Conditions

												
Movement	EBL	EBT	EBR	WBL	WBT	WBR	NBL	NBT	NBR	SBL	SBT	SBR
Lane Configurations												
Traffic Volume (veh/h)	35	345	10	5	445	5	0	0	5	0	0	110
Future Volume (Veh/h)	35	345	10	5	445	5	0	0	5	0	0	110
Sign Control		Free			Free			Stop			Stop	
Grade		0%			0%			0%			0%	
Peak Hour Factor	0.92	0.92	0.92	0.92	0.92	0.92	0.92	0.92	0.92	0.92	0.92	0.92
Hourly flow rate (vph)	38	375	11	5	484	5	0	0	5	0	0	120
Pedestrians												
Lane Width (m)												
Walking Speed (m/s)												
Percent Blockage												
Right turn flare (veh)												
Median type	None					None						
Median storage veh												
Upstream signal (m)												
pX, platoon unblocked												
vC, conflicting volume	489			386			828	956	193	765	958	244
vC1, stage 1 conf vol												
vC2, stage 2 conf vol												
vCu, unblocked vol	489			386			828	956	193	765	958	244
tC, single (s)	4.1			4.1			7.5	6.5	6.9	7.5	6.5	6.9
tC, 2 stage (s)												
tF (s)	2.2			2.2			3.5	4.0	3.3	3.5	4.0	3.3
p0 queue free %	96			100			100	100	99	100	100	84
cM capacity (veh/h)	1070			1169			215	247	816	282	246	756
Direction, Lane #	EB 1	EB 2	WB 1	WB 2	NB 1	SB 1						
Volume Total	226	198	247	247	5	120						
Volume Left	38	0	5	0	0	0						
Volume Right	0	11	0	5	5	120						
cSH	1070	1700	1169	1700	816	756						
Volume to Capacity	0.04	0.12	0.00	0.15	0.01	0.16						
Queue Length 95th (m)	0.9	0.0	0.1	0.0	0.1	4.5						
Control Delay (s)	1.7	0.0	0.2	0.0	9.4	10.7						
Lane LOS	A		A		A	B						
Approach Delay (s)	0.9		0.1		9.4	10.7						
Approach LOS					A	B						
Intersection Summary												
Average Delay			1.7									
Intersection Capacity Utilization			40.3%	ICU Level of Service	A							
Analysis Period (min)			15									

HCM Unsignalized Intersection Capacity Analysis
104: Clover Ave. & Little River Blvd.

AM Peak Hour
2022 Existing Conditions

												
Movement	EBL	EBT	EBR	WBL	WBT	WBR	NBL	NBT	NBR	SBL	SBT	SBR
Lane Configurations												
Traffic Volume (veh/h)	0	55	25	115	75	5	10	5	55	10	10	5
Future Volume (Veh/h)	0	55	25	115	75	5	10	5	55	10	10	5
Sign Control		Free			Free			Stop			Stop	
Grade		0%			0%			0%			0%	
Peak Hour Factor	0.92	0.92	0.92	0.92	0.92	0.92	0.92	0.92	0.92	0.92	0.92	0.92
Hourly flow rate (vph)	0	60	27	125	82	5	11	5	60	11	11	5
Pedestrians												
Lane Width (m)												
Walking Speed (m/s)												
Percent Blockage												
Right turn flare (veh)												
Median type		None			None							
Median storage (veh)												
Upstream signal (m)												
pX, platoon unblocked												
vC, conflicting volume	87			87			418	410	74	470	422	84
vC1, stage 1 conf vol												
vC2, stage 2 conf vol												
vCu, unblocked vol	87			87			418	410	74	470	422	84
tC, single (s)	4.1			4.1			7.1	6.5	6.2	7.1	6.5	6.2
tC, 2 stage (s)												
tF (s)	2.2			2.2			3.5	4.0	3.3	3.5	4.0	3.3
p0 queue free %	100			92			98	99	94	97	98	99
cM capacity (veh/h)	1509			1509			499	487	988	439	480	975
Direction, Lane #	EB 1	WB 1	NB 1	SB 1								
Volume Total	87	212	76	27								
Volume Left	0	125	11	11								
Volume Right	27	5	60	5								
cSH	1509	1509	817	509								
Volume to Capacity	0.00	0.08	0.09	0.05								
Queue Length 95th (m)	0.0	2.2	2.5	1.3								
Control Delay (s)	0.0	4.8	9.9	12.5								
Lane LOS		A	A	B								
Approach Delay (s)	0.0	4.8	9.9	12.5								
Approach LOS			A	B								
Intersection Summary												
Average Delay			5.2									
Intersection Capacity Utilization			28.4%		ICU Level of Service				A			
Analysis Period (min)			15									

HCM Unsignalized Intersection Capacity Analysis
101: Wyandotte St. & Florence Ave.

















PM Peak Hour
2022 Existing Conditions



Movement	EBL	EBT	WBT	WBR	SBL	SBR
Lane Configurations						
Traffic Volume (veh/h)	25	380	235	15	15	20
Future Volume (Veh/h)	25	380	235	15	15	20
Sign Control		Free	Free		Stop	
Grade		0%	0%		0%	
Peak Hour Factor	0.92	0.92	0.92	0.92	0.92	0.92
Hourly flow rate (vph)	27	413	255	16	16	22
Pedestrians						
Lane Width (m)						
Walking Speed (m/s)						
Percent Blockage						
Right turn flare (veh)						
Median type		None	None			
Median storage (veh)						
Upstream signal (m)						
pX, platoon unblocked						
vC, conflicting volume	271			730	263	
vC1, stage 1 conf vol						
vC2, stage 2 conf vol						
vCu, unblocked vol	271			730	263	
tC, single (s)	4.1			6.4	6.2	
tC, 2 stage (s)						
tF (s)	2.2			3.5	3.3	
p0 queue free %	98			96	97	
cM capacity (veh/h)	1292			381	776	
Direction, Lane #	EB 1	EB 2	WB 1	SB 1		
Volume Total	27	413	271	38		
Volume Left	27	0	0	16		
Volume Right	0	0	16	22		
cSH	1292	1700	1700	540		
Volume to Capacity	0.02	0.24	0.16	0.07		
Queue Length 95th (m)	0.5	0.0	0.0	1.8		
Control Delay (s)	7.8	0.0	0.0	12.2		
Lane LOS	A			B		
Approach Delay (s)	0.5	0.0		12.2		
Approach LOS				B		
Intersection Summary						
Average Delay			0.9			
Intersection Capacity Utilization			30.0%	ICU Level of Service	A	
Analysis Period (min)			15			

















HCM Unsignalized Intersection Capacity Analysis
102: Clover Ave. & Wyandotte St.

PM Peak Hour
2022 Existing Conditions

												
Movement	EBL	EBT	EBR	WBL	WBT	WBR	NBL	NBT	NBR	SBL	SBT	SBR
Lane Configurations												
Traffic Volume (veh/h)	10	375	0	0	245	10	0	0	0	5	0	5
Future Volume (Veh/h)	10	375	0	0	245	10	0	0	0	5	0	5
Sign Control		Free			Free			Stop			Stop	
Grade		0%			0%			0%			0%	
Peak Hour Factor	0.92	0.92	0.92	0.92	0.92	0.92	0.92	0.92	0.92	0.92	0.92	0.92
Hourly flow rate (vph)	11	408	0	0	266	11	0	0	0	5	0	5
Pedestrians												
Lane Width (m)												
Walking Speed (m/s)												
Percent Blockage												
Right turn flare (veh)												
Median type	None					None						
Median storage veh												
Upstream signal (m)												
pX, platoon unblocked												
vC, conflicting volume	277			408			706	707	408	702	702	272
vC1, stage 1 conf vol												
vC2, stage 2 conf vol												
vCu, unblocked vol	277			408			706	707	408	702	702	272
tC, single (s)	4.1			4.1			7.1	6.5	6.2	7.1	6.5	6.2
tC, 2 stage (s)												
tF (s)	2.2			2.2			3.5	4.0	3.3	3.5	4.0	3.3
p0 queue free %	99			100			100	100	100	99	100	99
cM capacity (veh/h)	1286			1151			346	357	643	351	360	767
Direction, Lane #	EB 1	WB 1	NB 1	SB 1								
Volume Total	419	277	0	10								
Volume Left	11	0	0	5								
Volume Right	0	11	0	5								
cSH	1286	1151	1700	481								
Volume to Capacity	0.01	0.00	0.00	0.02								
Queue Length 95th (m)	0.2	0.0	0.0	0.5								
Control Delay (s)	0.3	0.0	0.0	12.6								
Lane LOS	A		A	B								
Approach Delay (s)	0.3	0.0	0.0	12.6								
Approach LOS			A	B								
Intersection Summary												
Average Delay			0.4									
Intersection Capacity Utilization			37.8%	ICU Level of Service	A							
Analysis Period (min)			15									

















HCM Unsignalized Intersection Capacity Analysis
 103: McHugh Park Driveway/Florence Ave. & McHugh St.

PM Peak Hour
 2022 Existing Conditions

												
Movement	EBL	EBT	EBR	WBL	WBT	WBR	NBL	NBT	NBR	SBL	SBT	SBR
Lane Configurations												
Traffic Volume (veh/h)	120	390	10	5	420	5	5	0	0	0	0	95
Future Volume (Veh/h)	120	390	10	5	420	5	5	0	0	0	0	95
Sign Control		Free			Free			Stop				Stop
Grade		0%			0%			0%				0%
Peak Hour Factor	0.92	0.92	0.92	0.92	0.92	0.92	0.92	0.92	0.92	0.92	0.92	0.92
Hourly flow rate (vph)	130	424	11	5	457	5	5	0	0	0	0	103
Pedestrians												
Lane Width (m)												
Walking Speed (m/s)												
Percent Blockage												
Right turn flare (veh)												
Median type		None			None							
Median storage veh												
Upstream signal (m)												
pX, platoon unblocked												
vC, conflicting volume	462			435			1031	1162	218	942	1164	231
vC1, stage 1 conf vol												
vC2, stage 2 conf vol												
vCu, unblocked vol	462			435			1031	1162	218	942	1164	231
tC, single (s)	4.1			4.1			7.5	6.5	6.9	7.5	6.5	6.9
tC, 2 stage (s)												
tF (s)	2.2			2.2			3.5	4.0	3.3	3.5	4.0	3.3
p0 queue free %	88			100			97	100	100	100	100	87
cM capacity (veh/h)	1095			1121			147	170	787	197	169	771
Direction, Lane #	EB 1	EB 2	WB 1	WB 2	NB 1	SB 1						
Volume Total	342	223	234	234	5	103						
Volume Left	130	0	5	0	5	0						
Volume Right	0	11	0	5	0	103						
cSH	1095	1700	1121	1700	147	771						
Volume to Capacity	0.12	0.13	0.00	0.14	0.03	0.13						
Queue Length 95th (m)	3.2	0.0	0.1	0.0	0.8	3.7						
Control Delay (s)	4.1	0.0	0.2	0.0	30.3	10.4						
Lane LOS	A		A		D	B						
Approach Delay (s)	2.5		0.1		30.3	10.4						
Approach LOS					D	B						
Intersection Summary												
Average Delay			2.3									
Intersection Capacity Utilization			42.4%		ICU Level of Service				A			
Analysis Period (min)			15									

HCM Unsignalized Intersection Capacity Analysis
104: Clover Ave. & Little River Blvd.

PM Peak Hour
2022 Existing Conditions

												
Movement	EBL	EBT	EBR	WBL	WBT	WBR	NBL	NBT	NBR	SBL	SBT	SBR
Lane Configurations												
Traffic Volume (veh/h)	0	85	10	70	80	5	25	10	100	15	5	5
Future Volume (Veh/h)	0	85	10	70	80	5	25	10	100	15	5	5
Sign Control		Free			Free			Stop			Stop	
Grade		0%			0%			0%			0%	
Peak Hour Factor	0.92	0.92	0.92	0.92	0.92	0.92	0.92	0.92	0.92	0.92	0.92	0.92
Hourly flow rate (vph)	0	92	11	76	87	5	27	11	109	16	5	5
Pedestrians												
Lane Width (m)												
Walking Speed (m/s)												
Percent Blockage												
Right turn flare (veh)												
Median type		None			None							
Median storage (veh)												
Upstream signal (m)												
pX, platoon unblocked												
vC, conflicting volume	92			103			346	342	98	454	344	90
vC1, stage 1 conf vol												
vC2, stage 2 conf vol												
vCu, unblocked vol	92			103			346	342	98	454	344	90
tC, single (s)	4.1			4.1			7.1	6.5	6.2	7.1	6.5	6.2
tC, 2 stage (s)												
tF (s)	2.2			2.2			3.5	4.0	3.3	3.5	4.0	3.3
p0 queue free %	100			95			95	98	89	96	99	99
cM capacity (veh/h)	1503			1489			577	551	959	433	549	968
Direction, Lane #	EB 1	WB 1	NB 1	SB 1								
Volume Total	103	168	147	26								
Volume Left	0	76	27	16								
Volume Right	11	5	109	5								
cSH	1503	1489	815	508								
Volume to Capacity	0.00	0.05	0.18	0.05								
Queue Length 95th (m)	0.0	1.3	5.2	1.3								
Control Delay (s)	0.0	3.6	10.4	12.5								
Lane LOS		A	B	B								
Approach Delay (s)	0.0	3.6	10.4	12.5								
Approach LOS			B	B								
Intersection Summary												
Average Delay			5.5									
Intersection Capacity Utilization			29.8%		ICU Level of Service				A			
Analysis Period (min)			15									

HCM Unsignalized Intersection Capacity Analysis
101: Wyandotte St. & Florence Ave.



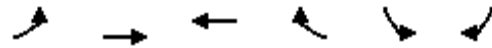













Saturday Peak Hour
2022 Existing Conditions



Movement	EBL	EBT	WBT	WBR	SBL	SBR
Lane Configurations						
Traffic Volume (veh/h)	20	245	200	10	10	30
Future Volume (Veh/h)	20	245	200	10	10	30
Sign Control		Free	Free		Stop	
Grade		0%	0%		0%	
Peak Hour Factor	0.92	0.92	0.92	0.92	0.92	0.92
Hourly flow rate (vph)	22	266	217	11	11	33
Pedestrians						
Lane Width (m)						
Walking Speed (m/s)						
Percent Blockage						
Right turn flare (veh)						
Median type		None	None			
Median storage (veh)						
Upstream signal (m)						
pX, platoon unblocked						
vC, conflicting volume	228				532	222
vC1, stage 1 conf vol						
vC2, stage 2 conf vol						
vCu, unblocked vol	228				532	222
tC, single (s)	4.1				6.4	6.2
tC, 2 stage (s)						
tF (s)	2.2				3.5	3.3
p0 queue free %	98				98	96
cM capacity (veh/h)	1340				499	817
Direction, Lane #	EB 1	EB 2	WB 1	SB 1		
Volume Total	22	266	228	44		
Volume Left	22	0	0	11		
Volume Right	0	0	11	33		
cSH	1340	1700	1700	705		
Volume to Capacity	0.02	0.16	0.13	0.06		
Queue Length 95th (m)	0.4	0.0	0.0	1.6		
Control Delay (s)	7.7	0.0	0.0	10.4		
Lane LOS	A			B		
Approach Delay (s)	0.6		0.0	10.4		
Approach LOS				B		
Intersection Summary						
Average Delay			1.1			
Intersection Capacity Utilization			26.6%	ICU Level of Service	A	
Analysis Period (min)			15			

















HCM Unsignalized Intersection Capacity Analysis
102: Clover Ave. & Wyandotte St.

Saturday Peak Hour
2022 Existing Conditions

												
Movement	EBL	EBT	EBR	WBL	WBT	WBR	NBL	NBT	NBR	SBL	SBT	SBR
Lane Configurations												
Traffic Volume (veh/h)	10	240	0	0	200	5	0	0	0	5	0	10
Future Volume (Veh/h)	10	240	0	0	200	5	0	0	0	5	0	10
Sign Control		Free			Free			Stop			Stop	
Grade		0%			0%			0%			0%	
Peak Hour Factor	0.92	0.92	0.92	0.92	0.92	0.92	0.92	0.92	0.92	0.92	0.92	0.92
Hourly flow rate (vph)	11	261	0	0	217	5	0	0	0	5	0	11
Pedestrians												
Lane Width (m)												
Walking Speed (m/s)												
Percent Blockage												
Right turn flare (veh)												
Median type		None			None							
Median storage veh												
Upstream signal (m)												
pX, platoon unblocked												
vC, conflicting volume	222			261			514	505	261	502	502	220
vC1, stage 1 conf vol												
vC2, stage 2 conf vol												
vCu, unblocked vol	222			261			514	505	261	502	502	220
tC, single (s)	4.1			4.1			7.1	6.5	6.2	7.1	6.5	6.2
tC, 2 stage (s)												
tF (s)	2.2			2.2			3.5	4.0	3.3	3.5	4.0	3.3
p0 queue free %	99			100			100	100	100	99	100	99
cM capacity (veh/h)	1347			1303			462	466	778	476	467	820
Direction, Lane #	EB 1	WB 1	NB 1	SB 1								
Volume Total	272	222	0	16								
Volume Left	11	0	0	5								
Volume Right	0	5	0	11								
cSH	1347	1303	1700	669								
Volume to Capacity	0.01	0.00	0.00	0.02								
Queue Length 95th (m)	0.2	0.0	0.0	0.6								
Control Delay (s)	0.4	0.0	0.0	10.5								
Lane LOS	A		A	B								
Approach Delay (s)	0.4	0.0	0.0	10.5								
Approach LOS			A	B								
Intersection Summary												
Average Delay			0.5									
Intersection Capacity Utilization			30.7%		ICU Level of Service				A			
Analysis Period (min)			15									

















HCM Unsignalized Intersection Capacity Analysis
 103: McHugh Park Driveway/Florence Ave. & McHugh St.

Saturday Peak Hour
 2022 Existing Conditions

												
Movement	EBL	EBT	EBR	WBL	WBT	WBR	NBL	NBT	NBR	SBL	SBT	SBR
Lane Configurations												
Traffic Volume (veh/h)	90	285	0	5	300	5	10	0	5	5	0	105
Future Volume (Veh/h)	90	285	0	5	300	5	10	0	5	5	0	105
Sign Control		Free			Free			Stop			Stop	
Grade		0%			0%			0%			0%	
Peak Hour Factor	0.92	0.92	0.92	0.92	0.92	0.92	0.92	0.92	0.92	0.92	0.92	0.92
Hourly flow rate (vph)	98	310	0	5	326	5	11	0	5	5	0	114
Pedestrians												
Lane Width (m)												
Walking Speed (m/s)												
Percent Blockage												
Right turn flare (veh)												
Median type		None			None							
Median storage (veh)												
Upstream signal (m)												
pX, platoon unblocked												
vC, conflicting volume	331			310			793	847	155	694	844	166
vC1, stage 1 conf vol												
vC2, stage 2 conf vol												
vCu, unblocked vol	331			310			793	847	155	694	844	166
tC, single (s)	4.1			4.1			7.5	6.5	6.9	7.5	6.5	6.9
tC, 2 stage (s)												
tF (s)	2.2			2.2			3.5	4.0	3.3	3.5	4.0	3.3
p0 queue free %	92			100			95	100	99	98	100	87
cM capacity (veh/h)	1225			1247			226	272	863	306	273	850
Direction, Lane #	EB 1	EB 2	WB 1	WB 2	NB 1	SB 1						
Volume Total	253	155	168	168	16	119						
Volume Left	98	0	5	0	11	5						
Volume Right	0	0	0	5	5	114						
cSH	1225	1700	1247	1700	294	791						
Volume to Capacity	0.08	0.09	0.00	0.10	0.05	0.15						
Queue Length 95th (m)	2.1	0.0	0.1	0.0	1.4	4.2						
Control Delay (s)	3.6	0.0	0.3	0.0	17.9	10.4						
Lane LOS	A		A		C	B						
Approach Delay (s)	2.2		0.1		17.9	10.4						
Approach LOS					C	B						
Intersection Summary												
Average Delay			2.8									
Intersection Capacity Utilization			35.8%		ICU Level of Service				A			
Analysis Period (min)			15									



















HCM Unsignalized Intersection Capacity Analysis
104: Clover Ave. & Little River Blvd.

Saturday Peak Hour
2022 Existing Conditions

												
Movement	EBL	EBT	EBR	WBL	WBT	WBR	NBL	NBT	NBR	SBL	SBT	SBR
Lane Configurations												
Traffic Volume (veh/h)	5	80	15	45	105	15	5	15	55	15	15	0
Future Volume (Veh/h)	5	80	15	45	105	15	5	15	55	15	15	0
Sign Control		Free			Free			Stop			Stop	
Grade		0%			0%			0%			0%	
Peak Hour Factor	0.92	0.92	0.92	0.92	0.92	0.92	0.92	0.92	0.92	0.92	0.92	0.92
Hourly flow rate (vph)	5	87	16	49	114	16	5	16	60	16	16	0
Pedestrians												
Lane Width (m)												
Walking Speed (m/s)												
Percent Blockage												
Right turn flare (veh)												
Median type		None			None							
Median storage veh												
Upstream signal (m)												
pX, platoon unblocked												
vC, conflicting volume	130			103			333	333	95	393	333	122
vC1, stage 1 conf vol												
vC2, stage 2 conf vol												
vCu, unblocked vol	130			103			333	333	95	393	333	122
tC, single (s)	4.1			4.1			7.1	6.5	6.2	7.1	6.5	6.2
tC, 2 stage (s)												
tF (s)	2.2			2.2			3.5	4.0	3.3	3.5	4.0	3.3
p0 queue free %	100			97			99	97	94	97	97	100
cM capacity (veh/h)	1455			1489			590	566	962	505	566	929
Direction, Lane #	EB 1	WB 1	NB 1	SB 1								
Volume Total	108	179	81	32								
Volume Left	5	49	5	16								
Volume Right	16	16	60	0								
cSH	1455	1489	817	534								
Volume to Capacity	0.00	0.03	0.10	0.06								
Queue Length 95th (m)	0.1	0.8	2.6	1.5								
Control Delay (s)	0.4	2.2	9.9	12.2								
Lane LOS	A	A	A	B								
Approach Delay (s)	0.4	2.2	9.9	12.2								
Approach LOS			A	B								
Intersection Summary												
Average Delay			4.1									
Intersection Capacity Utilization			28.8%		ICU Level of Service				A			
Analysis Period (min)			15									

















HCM Unsignalized Intersection Capacity Analysis
101: Florence Ave. & Wyandotte St.

AM Peak Hour
2027 Future Background Conditions

												
Movement	EBL	EBT	EBR	WBL	WBT	WBR	NBL	NBT	NBR	SBL	SBT	SBR
Lane Configurations												
Traffic Volume (veh/h)	15	325	20	5	390	0	40	5	15	10	5	25
Future Volume (Veh/h)	15	325	20	5	390	0	40	5	15	10	5	25
Sign Control		Free			Free			Stop			Stop	
Grade		0%			0%			0%			0%	
Peak Hour Factor	0.92	0.92	0.92	0.92	0.92	0.92	0.92	0.92	0.92	0.92	0.92	0.92
Hourly flow rate (vph)	16	353	22	5	424	0	43	5	16	11	5	27
Pedestrians												
Lane Width (m)												
Walking Speed (m/s)												
Percent Blockage												
Right turn flare (veh)												
Median type	None					None						
Median storage veh												
Upstream signal (m)												
pX, platoon unblocked												
vC, conflicting volume	424			375			860	830	364	838	841	424
vC1, stage 1 conf vol												
vC2, stage 2 conf vol												
vCu, unblocked vol	424			375			860	830	364	838	841	424
tC, single (s)	4.1			4.1			7.1	6.5	6.2	7.1	6.5	6.2
tC, 2 stage (s)												
tF (s)	2.2			2.2			3.5	4.0	3.3	3.5	4.0	3.3
p0 queue free %	99			100			83	98	98	96	98	96
cM capacity (veh/h)	1135			1183			257	300	681	272	296	630
Direction, Lane #	EB 1	EB 2	WB 1	WB 2	NB 1	SB 1						
Volume Total	16	375	5	424	64	43						
Volume Left	16	0	5	0	43	11						
Volume Right	0	22	0	0	16	27						
cSH	1135	1700	1183	1700	309	429						
Volume to Capacity	0.01	0.22	0.00	0.25	0.21	0.10						
Queue Length 95th (m)	0.3	0.0	0.1	0.0	6.1	2.7						
Control Delay (s)	8.2	0.0	8.1	0.0	19.7	14.3						
Lane LOS	A		A		C	B						
Approach Delay (s)	0.3		0.1		19.7	14.3						
Approach LOS					C	B						
Intersection Summary												
Average Delay			2.2									
Intersection Capacity Utilization			35.0%		ICU Level of Service				A			
Analysis Period (min)			15									

















HCM Unsignalized Intersection Capacity Analysis
102: Clover Ave. & Wyandotte St.

AM Peak Hour
2027 Future Background Conditions

												
Movement	EBL	EBT	EBR	WBL	WBT	WBR	NBL	NBT	NBR	SBL	SBT	SBR
Lane Configurations												
Traffic Volume (veh/h)	5	340	0	0	380	20	0	0	0	15	0	5
Future Volume (Veh/h)	5	340	0	0	380	20	0	0	0	15	0	5
Sign Control		Free			Free			Stop			Stop	
Grade		0%			0%			0%			0%	
Peak Hour Factor	0.92	0.92	0.92	0.92	0.92	0.92	0.92	0.92	0.92	0.92	0.92	0.92
Hourly flow rate (vph)	5	370	0	0	413	22	0	0	0	16	0	5
Pedestrians												
Lane Width (m)												
Walking Speed (m/s)												
Percent Blockage												
Right turn flare (veh)												
Median type		None			None							
Median storage veh												
Upstream signal (m)												
pX, platoon unblocked												
vC, conflicting volume	435			370			809	815	370	804	804	424
vC1, stage 1 conf vol												
vC2, stage 2 conf vol												
vCu, unblocked vol	435			370			809	815	370	804	804	424
tC, single (s)	4.1			4.1			7.1	6.5	6.2	7.1	6.5	6.2
tC, 2 stage (s)												
tF (s)	2.2			2.2			3.5	4.0	3.3	3.5	4.0	3.3
p0 queue free %	100			100			100	100	100	95	100	99
cM capacity (veh/h)	1125			1189			296	310	676	300	315	630
Direction, Lane #	EB 1	WB 1	NB 1	SB 1								
Volume Total	375	435	0	21								
Volume Left	5	0	0	16								
Volume Right	0	22	0	5								
cSH	1125	1189	1700	343								
Volume to Capacity	0.00	0.00	0.00	0.06								
Queue Length 95th (m)	0.1	0.0	0.0	1.6								
Control Delay (s)	0.2	0.0	0.0	16.2								
Lane LOS	A		A	C								
Approach Delay (s)	0.2	0.0	0.0	16.2								
Approach LOS			A	C								
Intersection Summary												
Average Delay			0.5									
Intersection Capacity Utilization			31.9%		ICU Level of Service				A			
Analysis Period (min)			15									

















HCM Unsignalized Intersection Capacity Analysis
 103: McHugh Park Driveway/Florence Ave. & McHugh St.

AM Peak Hour
 2027 Future Background Conditions

												
Movement	EBL	EBT	EBR	WBL	WBT	WBR	NBL	NBT	NBR	SBL	SBT	SBR
Lane Configurations												
Traffic Volume (veh/h)	40	375	10	5	470	5	0	0	5	0	0	140
Future Volume (Veh/h)	40	375	10	5	470	5	0	0	5	0	0	140
Sign Control		Free			Free			Stop			Stop	
Grade		0%			0%			0%			0%	
Peak Hour Factor	0.92	0.92	0.92	0.92	0.92	0.92	0.92	0.92	0.92	0.92	0.92	0.92
Hourly flow rate (vph)	43	408	11	5	511	5	0	0	5	0	0	152
Pedestrians												
Lane Width (m)												
Walking Speed (m/s)												
Percent Blockage												
Right turn flare (veh)												
Median type		None			None							
Median storage veh												
Upstream signal (m)												
pX, platoon unblocked												
vC, conflicting volume	516			419			917	1026	210	818	1028	258
vC1, stage 1 conf vol												
vC2, stage 2 conf vol												
vCu, unblocked vol	516			419			917	1026	210	818	1028	258
tC, single (s)	4.1			4.1			7.5	6.5	6.9	7.5	6.5	6.9
tC, 2 stage (s)												
tF (s)	2.2			2.2			3.5	4.0	3.3	3.5	4.0	3.3
p0 queue free %	96			100			100	100	99	100	100	79
cM capacity (veh/h)	1046			1137			174	223	796	257	222	741
Direction, Lane #	EB 1	EB 2	WB 1	WB 2	NB 1	SB 1						
Volume Total	247	215	260	260	5	152						
Volume Left	43	0	5	0	0	0						
Volume Right	0	11	0	5	5	152						
cSH	1046	1700	1137	1700	796	741						
Volume to Capacity	0.04	0.13	0.00	0.15	0.01	0.21						
Queue Length 95th (m)	1.0	0.0	0.1	0.0	0.2	6.1						
Control Delay (s)	1.8	0.0	0.2	0.0	9.5	11.1						
Lane LOS	A		A		A	B						
Approach Delay (s)	1.0		0.1		9.5	11.1						
Approach LOS					A	B						
Intersection Summary												
Average Delay			2.0									
Intersection Capacity Utilization			43.8%		ICU Level of Service				A			
Analysis Period (min)			15									











HCM Unsignalized Intersection Capacity Analysis
104: Clover Ave. & Little River Blvd.

AM Peak Hour
2027 Future Background Conditions

												
Movement	EBL	EBT	EBR	WBL	WBT	WBR	NBL	NBT	NBR	SBL	SBT	SBR
Lane Configurations												
Traffic Volume (veh/h)	0	60	30	125	105	5	10	20	60	15	15	5
Future Volume (Veh/h)	0	60	30	125	105	5	10	20	60	15	15	5
Sign Control		Free			Free			Stop			Stop	
Grade		0%			0%			0%			0%	
Peak Hour Factor	0.92	0.92	0.92	0.92	0.92	0.92	0.92	0.92	0.92	0.92	0.92	0.92
Hourly flow rate (vph)	0	65	33	136	114	5	11	22	65	16	16	5
Pedestrians												
Lane Width (m)												
Walking Speed (m/s)												
Percent Blockage												
Right turn flare (veh)												
Median type		None			None							
Median storage veh												
Upstream signal (m)												
pX, platoon unblocked												
vC, conflicting volume	119			98			483	472	82	546	486	116
vC1, stage 1 conf vol												
vC2, stage 2 conf vol												
vCu, unblocked vol	119			98			483	472	82	546	486	116
tC, single (s)	4.1			4.1			7.1	6.5	6.2	7.1	6.5	6.2
tC, 2 stage (s)												
tF (s)	2.2			2.2			3.5	4.0	3.3	3.5	4.0	3.3
p0 queue free %	100			91			98	95	93	96	96	99
cM capacity (veh/h)	1469			1495			444	445	978	375	437	936
Direction, Lane #	EB 1	WB 1	NB 1	SB 1								
Volume Total	98	255	98	37								
Volume Left	0	136	11	16								
Volume Right	33	5	65	5								
cSH	1469	1495	697	437								
Volume to Capacity	0.00	0.09	0.14	0.08								
Queue Length 95th (m)	0.0	2.4	3.9	2.2								
Control Delay (s)	0.0	4.4	11.0	14.0								
Lane LOS		A	B	B								
Approach Delay (s)	0.0	4.4	11.0	14.0								
Approach LOS			B	B								
Intersection Summary												
Average Delay			5.6									
Intersection Capacity Utilization			31.5%	ICU Level of Service	A							
Analysis Period (min)			15									









HCM Unsignalized Intersection Capacity Analysis
201: Lublin Ave. & Wyandotte St.

AM Peak Hour
2027 Future Background Conditions

						
Movement	EBT	EBR	WBL	WBT	NBL	NBR
Lane Configurations						
Traffic Volume (veh/h)	350	10	0	345	25	0
Future Volume (Veh/h)	350	10	0	345	25	0
Sign Control	Free			Free	Stop	
Grade	0%			0%	0%	
Peak Hour Factor	0.92	0.92	0.92	0.92	0.92	0.92
Hourly flow rate (vph)	380	11	0	375	27	0
Pedestrians						
Lane Width (m)						
Walking Speed (m/s)						
Percent Blockage						
Right turn flare (veh)						
Median type	None		None			
Median storage (veh)						
Upstream signal (m)						
pX, platoon unblocked						
vC, conflicting volume			391		760	386
vC1, stage 1 conf vol						
vC2, stage 2 conf vol						
vCu, unblocked vol			391		760	386
tC, single (s)			4.1		6.4	6.2
tC, 2 stage (s)						
tF (s)			2.2		3.5	3.3
p0 queue free %			100		93	100
cM capacity (veh/h)			1168		374	662
Direction, Lane #	EB 1	WB 1	NB 1			
Volume Total	391	375	27			
Volume Left	0	0	27			
Volume Right	11	0	0			
cSH	1700	1168	374			
Volume to Capacity	0.23	0.00	0.07			
Queue Length 95th (m)	0.0	0.0	1.9			
Control Delay (s)	0.0	0.0	15.4			
Lane LOS			C			
Approach Delay (s)	0.0	0.0	15.4			
Approach LOS			C			
Intersection Summary						
Average Delay			0.5			
Intersection Capacity Utilization			29.0%	ICU Level of Service	A	
Analysis Period (min)			15			



















HCM Unsignalized Intersection Capacity Analysis
202: Icewater Ave. & Wyandotte St.

AM Peak Hour
2027 Future Background Conditions

						
Movement	EBT	EBR	WBL	WBT	NBL	NBR
Lane Configurations						
Traffic Volume (veh/h)	345	5	0	335	15	5
Future Volume (Veh/h)	345	5	0	335	15	5
Sign Control	Free			Free	Stop	
Grade	0%			0%	0%	
Peak Hour Factor	0.92	0.92	0.92	0.92	0.92	0.92
Hourly flow rate (vph)	375	5	0	364	16	5
Pedestrians						
Lane Width (m)						
Walking Speed (m/s)						
Percent Blockage						
Right turn flare (veh)						
Median type	None		None			
Median storage (veh)						
Upstream signal (m)						
pX, platoon unblocked						
vC, conflicting volume			380		742	378
vC1, stage 1 conf vol						
vC2, stage 2 conf vol						
vCu, unblocked vol			380		742	378
tC, single (s)			4.1		6.4	6.2
tC, 2 stage (s)						
tF (s)			2.2		3.5	3.3
p0 queue free %			100		96	99
cM capacity (veh/h)			1178		383	669
Direction, Lane #	EB 1	WB 1	NB 1			
Volume Total	380	364	21			
Volume Left	0	0	16			
Volume Right	5	0	5			
cSH	1700	1178	427			
Volume to Capacity	0.22	0.00	0.05			
Queue Length 95th (m)	0.0	0.0	1.2			
Control Delay (s)	0.0	0.0	13.9			
Lane LOS			B			
Approach Delay (s)	0.0	0.0	13.9			
Approach LOS			B			
Intersection Summary						
Average Delay			0.4			
Intersection Capacity Utilization			28.5%	ICU Level of Service		A
Analysis Period (min)			15			

















HCM Unsignalized Intersection Capacity Analysis
101: Florence Ave. & Wyandotte St.

PM Peak Hour
2027 Future Background Conditions

												
Movement	EBL	EBT	EBR	WBL	WBT	WBR	NBL	NBT	NBR	SBL	SBT	SBR
Lane Configurations												
Traffic Volume (veh/h)	25	460	40	15	285	15	30	5	10	15	5	20
Future Volume (Veh/h)	25	460	40	15	285	15	30	5	10	15	5	20
Sign Control		Free			Free			Stop			Stop	
Grade		0%			0%			0%			0%	
Peak Hour Factor	0.92	0.92	0.92	0.92	0.92	0.92	0.92	0.92	0.92	0.92	0.92	0.92
Hourly flow rate (vph)	27	500	43	16	310	16	33	5	11	16	5	22
Pedestrians												
Lane Width (m)												
Walking Speed (m/s)												
Percent Blockage												
Right turn flare (veh)												
Median type		None			None							
Median storage (veh)												
Upstream signal (m)												
pX, platoon unblocked												
vC, conflicting volume	326			543			942	934	522	918	947	318
vC1, stage 1 conf vol												
vC2, stage 2 conf vol												
vCu, unblocked vol	326			543			942	934	522	918	947	318
tC, single (s)	4.1			4.1			7.1	6.5	6.2	7.1	6.5	6.2
tC, 2 stage (s)												
tF (s)	2.2			2.2			3.5	4.0	3.3	3.5	4.0	3.3
p0 queue free %	98			98			85	98	98	93	98	97
cM capacity (veh/h)	1234			1026			225	256	555	237	251	723
Direction, Lane #	EB 1	EB 2	WB 1	WB 2	NB 1	SB 1						
Volume Total	27	543	16	326	49	43						
Volume Left	27	0	16	0	33	16						
Volume Right	0	43	0	16	11	22						
cSH	1234	1700	1026	1700	264	365						
Volume to Capacity	0.02	0.32	0.02	0.19	0.19	0.12						
Queue Length 95th (m)	0.5	0.0	0.4	0.0	5.3	3.2						
Control Delay (s)	8.0	0.0	8.6	0.0	21.7	16.2						
Lane LOS	A		A		C	C						
Approach Delay (s)	0.4		0.4		21.7	16.2						
Approach LOS					C	C						
Intersection Summary												
Average Delay			2.1									
Intersection Capacity Utilization			37.7%		ICU Level of Service				A			
Analysis Period (min)			15									

















HCM Unsignalized Intersection Capacity Analysis
102: Clover Ave. & Wyandotte St.

PM Peak Hour
2027 Future Background Conditions

												
Movement	EBL	EBT	EBR	WBL	WBT	WBR	NBL	NBT	NBR	SBL	SBT	SBR
Lane Configurations												
Traffic Volume (veh/h)	10	470	0	0	310	20	0	0	0	20	0	5
Future Volume (Veh/h)	10	470	0	0	310	20	0	0	0	20	0	5
Sign Control		Free			Free			Stop			Stop	
Grade		0%			0%			0%			0%	
Peak Hour Factor	0.92	0.92	0.92	0.92	0.92	0.92	0.92	0.92	0.92	0.92	0.92	0.92
Hourly flow rate (vph)	11	511	0	0	337	22	0	0	0	22	0	5
Pedestrians												
Lane Width (m)												
Walking Speed (m/s)												
Percent Blockage												
Right turn flare (veh)												
Median type		None			None							
Median storage veh												
Upstream signal (m)												
pX, platoon unblocked												
vC, conflicting volume	359			511			886	892	511	881	881	348
vC1, stage 1 conf vol												
vC2, stage 2 conf vol												
vCu, unblocked vol	359			511			886	892	511	881	881	348
tC, single (s)	4.1			4.1			7.1	6.5	6.2	7.1	6.5	6.2
tC, 2 stage (s)												
tF (s)	2.2			2.2			3.5	4.0	3.3	3.5	4.0	3.3
p0 queue free %	99			100			100	100	100	92	100	99
cM capacity (veh/h)	1200			1054			261	279	563	265	283	695
Direction, Lane #	EB 1	WB 1	NB 1	SB 1								
Volume Total	522	359	0	27								
Volume Left	11	0	0	22								
Volume Right	0	22	0	5								
cSH	1200	1054	1700	300								
Volume to Capacity	0.01	0.00	0.00	0.09								
Queue Length 95th (m)	0.2	0.0	0.0	2.4								
Control Delay (s)	0.3	0.0	0.0	18.2								
Lane LOS	A		A	C								
Approach Delay (s)	0.3	0.0	0.0	18.2								
Approach LOS			A	C								
Intersection Summary												
Average Delay			0.7									
Intersection Capacity Utilization			42.8%		ICU Level of Service				A			
Analysis Period (min)			15									

















HCM Unsignalized Intersection Capacity Analysis
 103: McHugh Park Driveway/Florence Ave. & McHugh St.

PM Peak Hour
 2027 Future Background Conditions

												
Movement	EBL	EBT	EBR	WBL	WBT	WBR	NBL	NBT	NBR	SBL	SBT	SBR
Lane Configurations												
Traffic Volume (veh/h)	125	440	10	5	445	5	5	0	0	0	0	115
Future Volume (Veh/h)	125	440	10	5	445	5	5	0	0	0	0	115
Sign Control		Free			Free			Stop			Stop	
Grade		0%			0%			0%			0%	
Peak Hour Factor	0.92	0.92	0.92	0.92	0.92	0.92	0.92	0.92	0.92	0.92	0.92	0.92
Hourly flow rate (vph)	136	478	11	5	484	5	5	0	0	0	0	125
Pedestrians												
Lane Width (m)												
Walking Speed (m/s)												
Percent Blockage												
Right turn flare (veh)												
Median type		None			None							
Median storage veh												
Upstream signal (m)												
pX, platoon unblocked												
vC, conflicting volume	489			489			1132	1254	244	1008	1258	244
vC1, stage 1 conf vol												
vC2, stage 2 conf vol												
vCu, unblocked vol	489			489			1132	1254	244	1008	1258	244
tC, single (s)	4.1			4.1			7.5	6.5	6.9	7.5	6.5	6.9
tC, 2 stage (s)												
tF (s)	2.2			2.2			3.5	4.0	3.3	3.5	4.0	3.3
p0 queue free %	87			100			96	100	100	100	100	83
cM capacity (veh/h)	1070			1070			118	148	756	175	147	756
Direction, Lane #	EB 1	EB 2	WB 1	WB 2	NB 1	SB 1						
Volume Total	375	250	247	247	5	125						
Volume Left	136	0	5	0	5	0						
Volume Right	0	11	0	5	0	125						
cSH	1070	1700	1070	1700	118	756						
Volume to Capacity	0.13	0.15	0.00	0.15	0.04	0.17						
Queue Length 95th (m)	3.5	0.0	0.1	0.0	1.0	4.7						
Control Delay (s)	4.0	0.0	0.2	0.0	36.7	10.7						
Lane LOS	A		A		E	B						
Approach Delay (s)	2.4		0.1		36.7	10.7						
Approach LOS					E	B						
Intersection Summary												
Average Delay			2.5									
Intersection Capacity Utilization			45.8%		ICU Level of Service				A			
Analysis Period (min)			15									

HCM Unsignalized Intersection Capacity Analysis
104: Clover Ave. & Little River Blvd.

PM Peak Hour
2027 Future Background Conditions

												
Movement	EBL	EBT	EBR	WBL	WBT	WBR	NBL	NBT	NBR	SBL	SBT	SBR
Lane Configurations												
Traffic Volume (veh/h)	0	90	10	80	100	5	25	50	105	15	10	5
Future Volume (Veh/h)	0	90	10	80	100	5	25	50	105	15	10	5
Sign Control		Free			Free			Stop			Stop	
Grade		0%			0%			0%			0%	
Peak Hour Factor	0.92	0.92	0.92	0.92	0.92	0.92	0.92	0.92	0.92	0.92	0.92	0.92
Hourly flow rate (vph)	0	98	11	87	109	5	27	54	114	16	11	5
Pedestrians												
Lane Width (m)												
Walking Speed (m/s)												
Percent Blockage												
Right turn flare (veh)												
Median type		None			None							
Median storage veh												
Upstream signal (m)												
pX, platoon unblocked												
vC, conflicting volume	114			109			400	392	104	530	394	112
vC1, stage 1 conf vol												
vC2, stage 2 conf vol												
vCu, unblocked vol	114			109			400	392	104	530	394	112
tC, single (s)	4.1			4.1			7.1	6.5	6.2	7.1	6.5	6.2
tC, 2 stage (s)												
tF (s)	2.2			2.2			3.5	4.0	3.3	3.5	4.0	3.3
p0 queue free %	100			94			95	89	88	95	98	99
cM capacity (veh/h)	1475			1481			524	512	951	355	510	942
Direction, Lane #	EB 1	WB 1	NB 1	SB 1								
Volume Total	109	201	195	32								
Volume Left	0	87	27	16								
Volume Right	11	5	114	5								
cSH	1475	1481	705	445								
Volume to Capacity	0.00	0.06	0.28	0.07								
Queue Length 95th (m)	0.0	1.5	9.0	1.9								
Control Delay (s)	0.0	3.6	12.1	13.7								
Lane LOS		A	B	B								
Approach Delay (s)	0.0	3.6	12.1	13.7								
Approach LOS			B	B								
Intersection Summary												
Average Delay			6.5									
Intersection Capacity Utilization			34.0%	ICU Level of Service		A						
Analysis Period (min)			15									

HCM Unsignalized Intersection Capacity Analysis
201: Lublin Ave. & Wyandotte St.

PM Peak Hour
2027 Future Background Conditions



Movement	EBT	EBR	WBL	WBT	NBL	NBR
Lane Configurations						
Traffic Volume (veh/h)	435	25	0	300	15	0
Future Volume (Veh/h)	435	25	0	300	15	0
Sign Control	Free			Free	Stop	
Grade	0%			0%	0%	
Peak Hour Factor	0.92	0.92	0.92	0.92	0.92	0.92
Hourly flow rate (vph)	473	27	0	326	16	0
Pedestrians						
Lane Width (m)						
Walking Speed (m/s)						
Percent Blockage						
Right turn flare (veh)						
Median type	None		None			
Median storage (veh)						
Upstream signal (m)						
pX, platoon unblocked						
vC, conflicting volume			500		812	486
vC1, stage 1 conf vol						
vC2, stage 2 conf vol						
vCu, unblocked vol			500		812	486
tC, single (s)			4.1		6.4	6.2
tC, 2 stage (s)						
tF (s)			2.2		3.5	3.3
p0 queue free %			100		95	100
cM capacity (veh/h)			1064		348	581
Direction, Lane #	EB 1	WB 1	NB 1			
Volume Total	500	326	16			
Volume Left	0	0	16			
Volume Right	27	0	0			
cSH	1700	1064	348			
Volume to Capacity	0.29	0.00	0.05			
Queue Length 95th (m)	0.0	0.0	1.2			
Control Delay (s)	0.0	0.0	15.8			
Lane LOS			C			
Approach Delay (s)	0.0	0.0	15.8			
Approach LOS			C			
Intersection Summary						
Average Delay			0.3			
Intersection Capacity Utilization			34.4%	ICU Level of Service		A
Analysis Period (min)			15			

HCM Unsignalized Intersection Capacity Analysis
 202: Icewater Ave. & Wyandotte St.



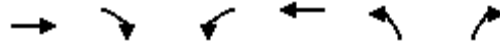















PM Peak Hour
 2027 Future Background Conditions



Movement	EBT	EBR	WBL	WBT	NBL	NBR
Lane Configurations	→			←	↘	↙
Traffic Volume (veh/h)	420	15	5	295	10	0
Future Volume (Veh/h)	420	15	5	295	10	0
Sign Control	Free			Free	Stop	
Grade	0%			0%	0%	
Peak Hour Factor	0.92	0.92	0.92	0.92	0.92	0.92
Hourly flow rate (vph)	457	16	5	321	11	0
Pedestrians						
Lane Width (m)						
Walking Speed (m/s)						
Percent Blockage						
Right turn flare (veh)						
Median type	None		None			
Median storage (veh)						
Upstream signal (m)						
pX, platoon unblocked						
vC, conflicting volume			473		796	465
vC1, stage 1 conf vol						
vC2, stage 2 conf vol						
vCu, unblocked vol			473		796	465
tC, single (s)			4.1		6.4	6.2
tC, 2 stage (s)						
tF (s)			2.2		3.5	3.3
p0 queue free %			100		97	100
cM capacity (veh/h)			1089		354	597
Direction, Lane #	EB 1	WB 1	NB 1			
Volume Total	473	326	11			
Volume Left	0	5	11			
Volume Right	16	0	0			
cSH	1700	1089	354			
Volume to Capacity	0.28	0.00	0.03			
Queue Length 95th (m)	0.0	0.1	0.8			
Control Delay (s)	0.0	0.2	15.5			
Lane LOS			A	C		
Approach Delay (s)	0.0	0.2	15.5			
Approach LOS			C			
Intersection Summary						
Average Delay			0.3			
Intersection Capacity Utilization			33.0%	ICU Level of Service		A
Analysis Period (min)			15			

















HCM Unsignalized Intersection Capacity Analysis
101: Florence Ave. & Wyandotte St.

Saturday Peak Hour
2027 Future Background Conditions

												
Movement	EBL	EBT	EBR	WBL	WBT	WBR	NBL	NBT	NBR	SBL	SBT	SBR
Lane Configurations												
Traffic Volume (veh/h)	20	305	40	15	255	10	35	5	15	10	5	30
Future Volume (Veh/h)	20	305	40	15	255	10	35	5	15	10	5	30
Sign Control		Free			Free			Stop			Stop	
Grade		0%			0%			0%			0%	
Peak Hour Factor	0.92	0.92	0.92	0.92	0.92	0.92	0.92	0.92	0.92	0.92	0.92	0.92
Hourly flow rate (vph)	22	332	43	16	277	11	38	5	16	11	5	33
Pedestrians												
Lane Width (m)												
Walking Speed (m/s)												
Percent Blockage												
Right turn flare (veh)												
Median type		None			None							
Median storage veh												
Upstream signal (m)												
pX, platoon unblocked												
vC, conflicting volume	288			375			742	718	354	709	734	282
vC1, stage 1 conf vol												
vC2, stage 2 conf vol												
vCu, unblocked vol	288			375			742	718	354	709	734	282
tC, single (s)	4.1			4.1			7.1	6.5	6.2	7.1	6.5	6.2
tC, 2 stage (s)												
tF (s)	2.2			2.2			3.5	4.0	3.3	3.5	4.0	3.3
p0 queue free %	98			99			88	99	98	97	99	96
cM capacity (veh/h)	1274			1183			306	344	690	329	337	756
Direction, Lane #	EB 1	EB 2	WB 1	WB 2	NB 1	SB 1						
Volume Total	22	375	16	288	59	49						
Volume Left	22	0	16	0	38	11						
Volume Right	0	43	0	11	16	33						
cSH	1274	1700	1183	1700	365	533						
Volume to Capacity	0.02	0.22	0.01	0.17	0.16	0.09						
Queue Length 95th (m)	0.4	0.0	0.3	0.0	4.6	2.4						
Control Delay (s)	7.9	0.0	8.1	0.0	16.8	12.4						
Lane LOS	A		A		C	B						
Approach Delay (s)	0.4		0.4		16.8	12.4						
Approach LOS					C	B						
Intersection Summary												
Average Delay			2.3									
Intersection Capacity Utilization			32.6%		ICU Level of Service				A			
Analysis Period (min)			15									

















HCM Unsignalized Intersection Capacity Analysis
102: Clover Ave. & Wyandotte St.

Saturday Peak Hour
2027 Future Background Conditions

												
Movement	EBL	EBT	EBR	WBL	WBT	WBR	NBL	NBT	NBR	SBL	SBT	SBR
Lane Configurations												
Traffic Volume (veh/h)	10	315	0	0	270	20	0	0	0	15	0	15
Future Volume (Veh/h)	10	315	0	0	270	20	0	0	0	15	0	15
Sign Control		Free			Free			Stop			Stop	
Grade		0%			0%			0%			0%	
Peak Hour Factor	0.92	0.92	0.92	0.92	0.92	0.92	0.92	0.92	0.92	0.92	0.92	0.92
Hourly flow rate (vph)	11	342	0	0	293	22	0	0	0	16	0	16
Pedestrians												
Lane Width (m)												
Walking Speed (m/s)												
Percent Blockage												
Right turn flare (veh)												
Median type		None			None							
Median storage veh												
Upstream signal (m)												
pX, platoon unblocked												
vC, conflicting volume	315			342			684	679	342	668	668	304
vC1, stage 1 conf vol												
vC2, stage 2 conf vol												
vCu, unblocked vol	315			342			684	679	342	668	668	304
tC, single (s)	4.1			4.1			7.1	6.5	6.2	7.1	6.5	6.2
tC, 2 stage (s)												
tF (s)	2.2			2.2			3.5	4.0	3.3	3.5	4.0	3.3
p0 queue free %	99			100			100	100	100	96	100	98
cM capacity (veh/h)	1245			1217			352	370	701	369	376	736
Direction, Lane #	EB 1	WB 1	NB 1	SB 1								
Volume Total	353	315	0	32								
Volume Left	11	0	0	16								
Volume Right	0	22	0	16								
cSH	1245	1217	1700	492								
Volume to Capacity	0.01	0.00	0.00	0.07								
Queue Length 95th (m)	0.2	0.0	0.0	1.7								
Control Delay (s)	0.3	0.0	0.0	12.8								
Lane LOS	A		A	B								
Approach Delay (s)	0.3	0.0	0.0	12.8								
Approach LOS			A	B								
Intersection Summary												
Average Delay			0.8									
Intersection Capacity Utilization			34.6%		ICU Level of Service				A			
Analysis Period (min)			15									

















HCM Unsignalized Intersection Capacity Analysis
 103: McHugh Park Driveway/Florence Ave. & McHugh St.

Saturday Peak Hour
 2027 Future Background Conditions

												
Movement	EBL	EBT	EBR	WBL	WBT	WBR	NBL	NBT	NBR	SBL	SBT	SBR
Lane Configurations												
Traffic Volume (veh/h)	90	325	0	5	315	5	10	0	5	5	0	130
Future Volume (Veh/h)	90	325	0	5	315	5	10	0	5	5	0	130
Sign Control		Free			Free			Stop			Stop	
Grade		0%			0%			0%			0%	
Peak Hour Factor	0.92	0.92	0.92	0.92	0.92	0.92	0.92	0.92	0.92	0.92	0.92	0.92
Hourly flow rate (vph)	98	353	0	5	342	5	11	0	5	5	0	141
Pedestrians												
Lane Width (m)												
Walking Speed (m/s)												
Percent Blockage												
Right turn flare (veh)												
Median type		None			None							
Median storage veh												
Upstream signal (m)												
pX, platoon unblocked												
vC, conflicting volume	347			353			871	906	176	732	904	174
vC1, stage 1 conf vol												
vC2, stage 2 conf vol												
vCu, unblocked vol	347			353			871	906	176	732	904	174
tC, single (s)	4.1			4.1			7.5	6.5	6.9	7.5	6.5	6.9
tC, 2 stage (s)												
tF (s)	2.2			2.2			3.5	4.0	3.3	3.5	4.0	3.3
p0 queue free %	92			100			94	100	99	98	100	83
cM capacity (veh/h)	1209			1202			191	251	836	287	252	840
Direction, Lane #	EB 1	EB 2	WB 1	WB 2	NB 1	SB 1						
Volume Total	274	176	176	176	16	146						
Volume Left	98	0	5	0	11	5						
Volume Right	0	0	0	5	5	141						
cSH	1209	1700	1202	1700	251	788						
Volume to Capacity	0.08	0.10	0.00	0.10	0.06	0.19						
Queue Length 95th (m)	2.1	0.0	0.1	0.0	1.6	5.4						
Control Delay (s)	3.4	0.0	0.3	0.0	20.3	10.6						
Lane LOS	A		A		C	B						
Approach Delay (s)	2.1		0.1		20.3	10.6						
Approach LOS					C	B						
Intersection Summary												
Average Delay			3.0									
Intersection Capacity Utilization			38.9%		ICU Level of Service				A			
Analysis Period (min)			15									

HCM Unsignalized Intersection Capacity Analysis
104: Clover Ave. & Little River Blvd.

Saturday Peak Hour
2027 Future Background Conditions

												
Movement	EBL	EBT	EBR	WBL	WBT	WBR	NBL	NBT	NBR	SBL	SBT	SBR
Lane Configurations												
Traffic Volume (veh/h)	5	85	15	55	130	15	5	50	55	15	20	0
Future Volume (Veh/h)	5	85	15	55	130	15	5	50	55	15	20	0
Sign Control		Free			Free			Stop			Stop	
Grade		0%			0%			0%			0%	
Peak Hour Factor	0.92	0.92	0.92	0.92	0.92	0.92	0.92	0.92	0.92	0.92	0.92	0.92
Hourly flow rate (vph)	5	92	16	60	141	16	5	54	60	16	22	0
Pedestrians												
Lane Width (m)												
Walking Speed (m/s)												
Percent Blockage												
Right turn flare (veh)												
Median type		None			None							
Median storage veh												
Upstream signal (m)												
pX, platoon unblocked												
vC, conflicting volume	157			108			390	387	100	466	387	149
vC1, stage 1 conf vol												
vC2, stage 2 conf vol												
vCu, unblocked vol	157			108			390	387	100	466	387	149
tC, single (s)	4.1			4.1			7.1	6.5	6.2	7.1	6.5	6.2
tC, 2 stage (s)												
tF (s)	2.2			2.2			3.5	4.0	3.3	3.5	4.0	3.3
p0 queue free %	100			96			99	90	94	96	96	100
cM capacity (veh/h)	1423			1483			532	523	956	423	523	898
Direction, Lane #	EB 1	WB 1	NB 1	SB 1								
Volume Total	113	217	119	38								
Volume Left	5	60	5	16								
Volume Right	16	16	60	0								
cSH	1423	1483	679	476								
Volume to Capacity	0.00	0.04	0.18	0.08								
Queue Length 95th (m)	0.1	1.0	5.1	2.1								
Control Delay (s)	0.4	2.3	11.4	13.2								
Lane LOS	A	A	B	B								
Approach Delay (s)	0.4	2.3	11.4	13.2								
Approach LOS			B	B								
Intersection Summary												
Average Delay			4.9									
Intersection Capacity Utilization			32.0%		ICU Level of Service				A			
Analysis Period (min)			15									









HCM Unsignalized Intersection Capacity Analysis
201: Lublin Ave. & Wyandotte St.

Saturday Peak Hour
2027 Future Background Conditions

	→	↘	↙	←	↖	↗
Movement	EBT	EBR	WBL	WBT	NBL	NBR
Lane Configurations	↗			↖	↘	
Traffic Volume (veh/h)	290	20	0	255	20	0
Future Volume (Veh/h)	290	20	0	255	20	0
Sign Control	Free			Free	Stop	
Grade	0%			0%	0%	
Peak Hour Factor	0.92	0.92	0.92	0.92	0.92	0.92
Hourly flow rate (vph)	315	22	0	277	22	0
Pedestrians						
Lane Width (m)						
Walking Speed (m/s)						
Percent Blockage						
Right turn flare (veh)						
Median type	None		None			
Median storage (veh)						
Upstream signal (m)						
pX, platoon unblocked						
vC, conflicting volume			337		603	326
vC1, stage 1 conf vol						
vC2, stage 2 conf vol						
vCu, unblocked vol			337		603	326
tC, single (s)			4.1		6.4	6.2
tC, 2 stage (s)						
tF (s)			2.2		3.5	3.3
p0 queue free %			100		95	100
cM capacity (veh/h)			1222		462	715
Direction, Lane #	EB 1	WB 1	NB 1			
Volume Total	337	277	22			
Volume Left	0	0	22			
Volume Right	22	0	0			
cSH	1700	1222	462			
Volume to Capacity	0.20	0.00	0.05			
Queue Length 95th (m)	0.0	0.0	1.2			
Control Delay (s)	0.0	0.0	13.2			
Lane LOS			B			
Approach Delay (s)	0.0	0.0	13.2			
Approach LOS			B			
Intersection Summary						
Average Delay			0.5			
Intersection Capacity Utilization			26.5%	ICU Level of Service		A
Analysis Period (min)			15			



















HCM Unsignalized Intersection Capacity Analysis
202: Icewater Ave. & Wyandotte St.

Saturday Peak Hour
2027 Future Background Conditions

						
Movement	EBT	EBR	WBL	WBT	NBL	NBR
Lane Configurations						
Traffic Volume (veh/h)	280	15	5	245	10	5
Future Volume (Veh/h)	280	15	5	245	10	5
Sign Control	Free			Free	Stop	
Grade	0%			0%	0%	
Peak Hour Factor	0.92	0.92	0.92	0.92	0.92	0.92
Hourly flow rate (vph)	304	16	5	266	11	5
Pedestrians						
Lane Width (m)						
Walking Speed (m/s)						
Percent Blockage						
Right turn flare (veh)						
Median type	None			None		
Median storage (veh)						
Upstream signal (m)						
pX, platoon unblocked						
vC, conflicting volume			320		588	312
vC1, stage 1 conf vol						
vC2, stage 2 conf vol						
vCu, unblocked vol			320		588	312
tC, single (s)			4.1		6.4	6.2
tC, 2 stage (s)						
tF (s)			2.2		3.5	3.3
p0 queue free %			100		98	99
cM capacity (veh/h)			1240		470	728
Direction, Lane #	EB 1	WB 1	NB 1			
Volume Total	320	271	16			
Volume Left	0	5	11			
Volume Right	16	0	5			
cSH	1700	1240	528			
Volume to Capacity	0.19	0.00	0.03			
Queue Length 95th (m)	0.0	0.1	0.7			
Control Delay (s)	0.0	0.2	12.0			
Lane LOS		A	B			
Approach Delay (s)	0.0	0.2	12.0			
Approach LOS			B			
Intersection Summary						
Average Delay			0.4			
Intersection Capacity Utilization			26.9%	ICU Level of Service	A	
Analysis Period (min)			15			

















HCM Unsignalized Intersection Capacity Analysis
101: Florence Ave. & Wyandotte St.

AM Peak Hour
2032 Future Background Conditions

												
Movement	EBL	EBT	EBR	WBL	WBT	WBR	NBL	NBT	NBR	SBL	SBT	SBR
Lane Configurations												
Traffic Volume (veh/h)	15	340	20	5	410	0	40	5	15	10	5	25
Future Volume (Veh/h)	15	340	20	5	410	0	40	5	15	10	5	25
Sign Control		Free			Free			Stop			Stop	
Grade		0%			0%			0%			0%	
Peak Hour Factor	0.92	0.92	0.92	0.92	0.92	0.92	0.92	0.92	0.92	0.92	0.92	0.92
Hourly flow rate (vph)	16	370	22	5	446	0	43	5	16	11	5	27
Pedestrians												
Lane Width (m)												
Walking Speed (m/s)												
Percent Blockage												
Right turn flare (veh)												
Median type		None			None							
Median storage veh												
Upstream signal (m)												
pX, platoon unblocked												
vC, conflicting volume	446			392			898	869	381	876	880	446
vC1, stage 1 conf vol												
vC2, stage 2 conf vol												
vCu, unblocked vol	446			392			898	869	381	876	880	446
tC, single (s)	4.1			4.1			7.1	6.5	6.2	7.1	6.5	6.2
tC, 2 stage (s)												
tF (s)	2.2			2.2			3.5	4.0	3.3	3.5	4.0	3.3
p0 queue free %	99			100			82	98	98	96	98	96
cM capacity (veh/h)	1114			1167			242	285	666	255	281	612
Direction, Lane #	EB 1	EB 2	WB 1	WB 2	NB 1	SB 1						
Volume Total	16	392	5	446	64	43						
Volume Left	16	0	5	0	43	11						
Volume Right	0	22	0	0	16	27						
cSH	1114	1700	1167	1700	292	410						
Volume to Capacity	0.01	0.23	0.00	0.26	0.22	0.10						
Queue Length 95th (m)	0.3	0.0	0.1	0.0	6.6	2.8						
Control Delay (s)	8.3	0.0	8.1	0.0	20.8	14.8						
Lane LOS	A		A		C	B						
Approach Delay (s)	0.3		0.1		20.8	14.8						
Approach LOS					C	B						
Intersection Summary												
Average Delay			2.2									
Intersection Capacity Utilization			36.0%		ICU Level of Service				A			
Analysis Period (min)			15									

















HCM Unsignalized Intersection Capacity Analysis
102: Clover Ave. & Wyandotte St.

AM Peak Hour
2032 Future Background Conditions

												
Movement	EBL	EBT	EBR	WBL	WBT	WBR	NBL	NBT	NBR	SBL	SBT	SBR
Lane Configurations												
Traffic Volume (veh/h)	10	360	0	0	395	25	0	0	0	15	0	5
Future Volume (Veh/h)	10	360	0	0	395	25	0	0	0	15	0	5
Sign Control		Free			Free			Stop			Stop	
Grade		0%			0%			0%			0%	
Peak Hour Factor	0.92	0.92	0.92	0.92	0.92	0.92	0.92	0.92	0.92	0.92	0.92	0.92
Hourly flow rate (vph)	11	391	0	0	429	27	0	0	0	16	0	5
Pedestrians												
Lane Width (m)												
Walking Speed (m/s)												
Percent Blockage												
Right turn flare (veh)												
Median type	None				None							
Median storage veh												
Upstream signal (m)												
pX, platoon unblocked												
vC, conflicting volume	456			391			860	869	391	856	856	442
vC1, stage 1 conf vol												
vC2, stage 2 conf vol												
vCu, unblocked vol	456			391			860	869	391	856	856	442
tC, single (s)	4.1			4.1			7.1	6.5	6.2	7.1	6.5	6.2
tC, 2 stage (s)												
tF (s)	2.2			2.2			3.5	4.0	3.3	3.5	4.0	3.3
p0 queue free %	99			100			100	100	100	94	100	99
cM capacity (veh/h)	1105			1168			272	287	658	276	292	615
Direction, Lane #	EB 1	WB 1	NB 1	SB 1								
Volume Total	402	456	0	21								
Volume Left	11	0	0	16								
Volume Right	0	27	0	5								
cSH	1105	1168	1700	318								
Volume to Capacity	0.01	0.00	0.00	0.07								
Queue Length 95th (m)	0.2	0.0	0.0	1.7								
Control Delay (s)	0.3	0.0	0.0	17.1								
Lane LOS	A		A	C								
Approach Delay (s)	0.3	0.0	0.0	17.1								
Approach LOS			A	C								
Intersection Summary												
Average Delay			0.6									
Intersection Capacity Utilization			37.0%	ICU Level of Service	A							
Analysis Period (min)			15									

















HCM Unsignalized Intersection Capacity Analysis
 103: McHugh Park Driveway/Florence Ave. & McHugh St.

AM Peak Hour
 2032 Future Background Conditions

													
Movement	EBL	EBT	EBR	WBL	WBT	WBR	NBL	NBT	NBR	SBL	SBT	SBR	
Lane Configurations													
Traffic Volume (veh/h)	40	390	10	5	495	5	0	0	5	0	0	145	
Future Volume (Veh/h)	40	390	10	5	495	5	0	0	5	0	0	145	
Sign Control		Free			Free			Stop			Stop		
Grade		0%			0%			0%			0%		
Peak Hour Factor	0.92	0.92	0.92	0.92	0.92	0.92	0.92	0.92	0.92	0.92	0.92	0.92	
Hourly flow rate (vph)	43	424	11	5	538	5	0	0	5	0	0	158	
Pedestrians													
Lane Width (m)													
Walking Speed (m/s)													
Percent Blockage													
Right turn flare (veh)													
Median type	None					None							
Median storage (veh)													
Upstream signal (m)													
pX, platoon unblocked													
vC, conflicting volume	543			435			952	1068	218	854	1072	272	
vC1, stage 1 conf vol													
vC2, stage 2 conf vol													
vCu, unblocked vol	543			435			952	1068	218	854	1072	272	
tC, single (s)	4.1			4.1			7.5	6.5	6.9	7.5	6.5	6.9	
tC, 2 stage (s)													
tF (s)	2.2			2.2			3.5	4.0	3.3	3.5	4.0	3.3	
p0 queue free %	96			100			100	100	99	100	100	78	
cM capacity (veh/h)	1022			1121			161	210	787	242	209	726	
Direction, Lane #	EB 1	EB 2	WB 1	WB 2	NB 1	SB 1							
Volume Total	255	223	274	274	5	158							
Volume Left	43	0	5	0	0	0							
Volume Right	0	11	0	5	5	158							
cSH	1022	1700	1121	1700	787	726							
Volume to Capacity	0.04	0.13	0.00	0.16	0.01	0.22							
Queue Length 95th (m)	1.1	0.0	0.1	0.0	0.2	6.6							
Control Delay (s)	1.8	0.0	0.2	0.0	9.6	11.3							
Lane LOS	A		A		A	B							
Approach Delay (s)	1.0		0.1		9.6	11.3							
Approach LOS					A	B							
Intersection Summary													
Average Delay			2.0										
Intersection Capacity Utilization			45.2%		ICU Level of Service			A					
Analysis Period (min)			15										









HCM Unsignalized Intersection Capacity Analysis
104: Clover Ave. & Little River Blvd.

AM Peak Hour
2032 Future Background Conditions

												
Movement	EBL	EBT	EBR	WBL	WBT	WBR	NBL	NBT	NBR	SBL	SBT	SBR
Lane Configurations												
Traffic Volume (veh/h)	0	60	30	135	110	5	10	20	65	15	15	5
Future Volume (Veh/h)	0	60	30	135	110	5	10	20	65	15	15	5
Sign Control		Free			Free			Stop			Stop	
Grade		0%			0%			0%			0%	
Peak Hour Factor	0.92	0.92	0.92	0.92	0.92	0.92	0.92	0.92	0.92	0.92	0.92	0.92
Hourly flow rate (vph)	0	65	33	147	120	5	11	22	71	16	16	5
Pedestrians												
Lane Width (m)												
Walking Speed (m/s)												
Percent Blockage												
Right turn flare (veh)												
Median type		None			None							
Median storage veh												
Upstream signal (m)												
pX, platoon unblocked												
vC, conflicting volume	125			98			511	500	82	580	514	122
vC1, stage 1 conf vol												
vC2, stage 2 conf vol												
vCu, unblocked vol	125			98			511	500	82	580	514	122
tC, single (s)	4.1			4.1			7.1	6.5	6.2	7.1	6.5	6.2
tC, 2 stage (s)												
tF (s)	2.2			2.2			3.5	4.0	3.3	3.5	4.0	3.3
p0 queue free %	100			90			97	95	93	95	96	99
cM capacity (veh/h)	1462			1495			423	426	978	351	418	929
Direction, Lane #	EB 1	WB 1	NB 1	SB 1								
Volume Total	98	272	104	37								
Volume Left	0	147	11	16								
Volume Right	33	5	71	5								
cSH	1462	1495	692	415								
Volume to Capacity	0.00	0.10	0.15	0.09								
Queue Length 95th (m)	0.0	2.6	4.2	2.3								
Control Delay (s)	0.0	4.5	11.1	14.5								
Lane LOS		A	B	B								
Approach Delay (s)	0.0	4.5	11.1	14.5								
Approach LOS			B	B								
Intersection Summary												
Average Delay			5.7									
Intersection Capacity Utilization			32.6%	ICU Level of Service		A						
Analysis Period (min)			15									











HCM Unsignalized Intersection Capacity Analysis
201: Lublin Ave. & Wyandotte St.

AM Peak Hour
2032 Future Background Conditions

						
Movement	EBT	EBR	WBL	WBT	NBL	NBR
Lane Configurations						
Traffic Volume (veh/h)	365	10	0	360	25	0
Future Volume (Veh/h)	365	10	0	360	25	0
Sign Control	Free			Free	Stop	
Grade	0%			0%	0%	
Peak Hour Factor	0.92	0.92	0.92	0.92	0.92	0.92
Hourly flow rate (vph)	397	11	0	391	27	0
Pedestrians						
Lane Width (m)						
Walking Speed (m/s)						
Percent Blockage						
Right turn flare (veh)						
Median type	None		None			
Median storage (veh)						
Upstream signal (m)						
pX, platoon unblocked						
vC, conflicting volume			408		794	402
vC1, stage 1 conf vol						
vC2, stage 2 conf vol						
vCu, unblocked vol			408		794	402
tC, single (s)			4.1		6.4	6.2
tC, 2 stage (s)						
tF (s)			2.2		3.5	3.3
p0 queue free %			100		92	100
cM capacity (veh/h)			1151		357	648
Direction, Lane #	EB 1	WB 1	NB 1			
Volume Total	408	391	27			
Volume Left	0	0	27			
Volume Right	11	0	0			
cSH	1700	1151	357			
Volume to Capacity	0.24	0.00	0.08			
Queue Length 95th (m)	0.0	0.0	2.0			
Control Delay (s)	0.0	0.0	15.9			
Lane LOS			C			
Approach Delay (s)	0.0	0.0	15.9			
Approach LOS			C			
Intersection Summary						
Average Delay			0.5			
Intersection Capacity Utilization			29.8%	ICU Level of Service		A
Analysis Period (min)			15			



















HCM Unsignalized Intersection Capacity Analysis
202: Icewater Ave. & Wyandotte St.

AM Peak Hour
2032 Future Background Conditions

						
Movement	EBT	EBR	WBL	WBT	NBL	NBR
Lane Configurations						
Traffic Volume (veh/h)	360	5	0	350	15	5
Future Volume (Veh/h)	360	5	0	350	15	5
Sign Control	Free			Free	Stop	
Grade	0%			0%	0%	
Peak Hour Factor	0.92	0.92	0.92	0.92	0.92	0.92
Hourly flow rate (vph)	391	5	0	380	16	5
Pedestrians						
Lane Width (m)						
Walking Speed (m/s)						
Percent Blockage						
Right turn flare (veh)						
Median type	None		None			
Median storage (veh)						
Upstream signal (m)						
pX, platoon unblocked						
vC, conflicting volume			396		774	394
vC1, stage 1 conf vol						
vC2, stage 2 conf vol						
vCu, unblocked vol			396		774	394
tC, single (s)			4.1		6.4	6.2
tC, 2 stage (s)						
tF (s)			2.2		3.5	3.3
p0 queue free %			100		96	99
cM capacity (veh/h)			1163		367	655
Direction, Lane #	EB 1	WB 1	NB 1			
Volume Total	396	380	21			
Volume Left	0	0	16			
Volume Right	5	0	5			
cSH	1700	1163	410			
Volume to Capacity	0.23	0.00	0.05			
Queue Length 95th (m)	0.0	0.0	1.3			
Control Delay (s)	0.0	0.0	14.3			
Lane LOS			B			
Approach Delay (s)	0.0	0.0	14.3			
Approach LOS			B			
Intersection Summary						
Average Delay			0.4			
Intersection Capacity Utilization			29.3%	ICU Level of Service		A
Analysis Period (min)			15			

















HCM Unsignalized Intersection Capacity Analysis
101: Florence Ave. & Wyandotte St.

PM Peak Hour
2032 Future Background Conditions

												
Movement	EBL	EBT	EBR	WBL	WBT	WBR	NBL	NBT	NBR	SBL	SBT	SBR
Lane Configurations												
Traffic Volume (veh/h)	30	480	40	15	295	20	30	5	10	15	5	20
Future Volume (Veh/h)	30	480	40	15	295	20	30	5	10	15	5	20
Sign Control		Free			Free			Stop			Stop	
Grade		0%			0%			0%			0%	
Peak Hour Factor	0.92	0.92	0.92	0.92	0.92	0.92	0.92	0.92	0.92	0.92	0.92	0.92
Hourly flow rate (vph)	33	522	43	16	321	22	33	5	11	16	5	22
Pedestrians												
Lane Width (m)												
Walking Speed (m/s)												
Percent Blockage												
Right turn flare (veh)												
Median type		None			None							
Median storage veh												
Upstream signal (m)												
pX, platoon unblocked												
vC, conflicting volume	343			565			987	984	544	966	995	332
vC1, stage 1 conf vol												
vC2, stage 2 conf vol												
vCu, unblocked vol	343			565			987	984	544	966	995	332
tC, single (s)	4.1			4.1			7.1	6.5	6.2	7.1	6.5	6.2
tC, 2 stage (s)												
tF (s)	2.2			2.2			3.5	4.0	3.3	3.5	4.0	3.3
p0 queue free %	97			98			84	98	98	93	98	97
cM capacity (veh/h)	1216			1007			209	238	539	218	234	710
Direction, Lane #	EB 1	EB 2	WB 1	WB 2	NB 1	SB 1						
Volume Total	33	565	16	343	49	43						
Volume Left	33	0	16	0	33	16						
Volume Right	0	43	0	22	11	22						
cSH	1216	1700	1007	1700	246	342						
Volume to Capacity	0.03	0.33	0.02	0.20	0.20	0.13						
Queue Length 95th (m)	0.7	0.0	0.4	0.0	5.8	3.4						
Control Delay (s)	8.0	0.0	8.6	0.0	23.3	17.0						
Lane LOS	A		A		C	C						
Approach Delay (s)	0.4		0.4		23.3	17.0						
Approach LOS					C	C						
Intersection Summary												
Average Delay			2.2									
Intersection Capacity Utilization			38.7%		ICU Level of Service				A			
Analysis Period (min)			15									

















HCM Unsignalized Intersection Capacity Analysis
102: Clover Ave. & Wyandotte St.

PM Peak Hour
2032 Future Background Conditions

												
Movement	EBL	EBT	EBR	WBL	WBT	WBR	NBL	NBT	NBR	SBL	SBT	SBR
Lane Configurations												
Traffic Volume (veh/h)	10	490	0	0	320	20	0	0	0	20	0	10
Future Volume (Veh/h)	10	490	0	0	320	20	0	0	0	20	0	10
Sign Control		Free			Free			Stop			Stop	
Grade		0%			0%			0%			0%	
Peak Hour Factor	0.92	0.92	0.92	0.92	0.92	0.92	0.92	0.92	0.92	0.92	0.92	0.92
Hourly flow rate (vph)	11	533	0	0	348	22	0	0	0	22	0	11
Pedestrians												
Lane Width (m)												
Walking Speed (m/s)												
Percent Blockage												
Right turn flare (veh)												
Median type		None			None							
Median storage veh												
Upstream signal (m)												
pX, platoon unblocked												
vC, conflicting volume	370			533			925	925	533	914	914	359
vC1, stage 1 conf vol												
vC2, stage 2 conf vol												
vCu, unblocked vol	370			533			925	925	533	914	914	359
tC, single (s)	4.1			4.1			7.1	6.5	6.2	7.1	6.5	6.2
tC, 2 stage (s)												
tF (s)	2.2			2.2			3.5	4.0	3.3	3.5	4.0	3.3
p0 queue free %	99			100			100	100	100	91	100	98
cM capacity (veh/h)	1189			1035			244	267	547	252	271	685
Direction, Lane #	EB 1	WB 1	NB 1	SB 1								
Volume Total	544	370	0	33								
Volume Left	11	0	0	22								
Volume Right	0	22	0	11								
cSH	1189	1035	1700	319								
Volume to Capacity	0.01	0.00	0.00	0.10								
Queue Length 95th (m)	0.2	0.0	0.0	2.7								
Control Delay (s)	0.3	0.0	0.0	17.6								
Lane LOS	A		A	C								
Approach Delay (s)	0.3	0.0	0.0	17.6								
Approach LOS			A	C								
Intersection Summary												
Average Delay			0.8									
Intersection Capacity Utilization			43.8%		ICU Level of Service				A			
Analysis Period (min)			15									

















HCM Unsignalized Intersection Capacity Analysis
 103: McHugh Park Driveway/Florence Ave. & McHugh St.

PM Peak Hour
 2032 Future Background Conditions

												
Movement	EBL	EBT	EBR	WBL	WBT	WBR	NBL	NBT	NBR	SBL	SBT	SBR
Lane Configurations												
Traffic Volume (veh/h)	130	465	10	5	465	5	10	0	0	0	0	120
Future Volume (Veh/h)	130	465	10	5	465	5	10	0	0	0	0	120
Sign Control		Free			Free			Stop				Stop
Grade		0%			0%			0%				0%
Peak Hour Factor	0.92	0.92	0.92	0.92	0.92	0.92	0.92	0.92	0.92	0.92	0.92	0.92
Hourly flow rate (vph)	141	505	11	5	505	5	11	0	0	0	0	130
Pedestrians												
Lane Width (m)												
Walking Speed (m/s)												
Percent Blockage												
Right turn flare (veh)												
Median type		None			None							
Median storage veh												
Upstream signal (m)												
pX, platoon unblocked												
vC, conflicting volume	510			516			1185	1312	258	1052	1316	255
vC1, stage 1 conf vol												
vC2, stage 2 conf vol												
vCu, unblocked vol	510			516			1185	1312	258	1052	1316	255
tC, single (s)	4.1			4.1			7.5	6.5	6.9	7.5	6.5	6.9
tC, 2 stage (s)												
tF (s)	2.2			2.2			3.5	4.0	3.3	3.5	4.0	3.3
p0 queue free %	87			100			90	100	100	100	100	83
cM capacity (veh/h)	1051			1046			107	136	741	162	135	744
Direction, Lane #	EB 1	EB 2	WB 1	WB 2	NB 1	SB 1						
Volume Total	394	264	258	258	11	130						
Volume Left	141	0	5	0	11	0						
Volume Right	0	11	0	5	0	130						
cSH	1051	1700	1046	1700	107	744						
Volume to Capacity	0.13	0.15	0.00	0.15	0.10	0.17						
Queue Length 95th (m)	3.7	0.0	0.1	0.0	2.7	5.0						
Control Delay (s)	4.1	0.0	0.2	0.0	42.7	10.9						
Lane LOS	A		A		E	B						
Approach Delay (s)	2.5		0.1		42.7	10.9						
Approach LOS					E	B						
Intersection Summary												
Average Delay			2.7									
Intersection Capacity Utilization			47.5%		ICU Level of Service				A			
Analysis Period (min)			15									









HCM Unsignalized Intersection Capacity Analysis
104: Clover Ave. & Little River Blvd.

PM Peak Hour
2032 Future Background Conditions

												
Movement	EBL	EBT	EBR	WBL	WBT	WBR	NBL	NBT	NBR	SBL	SBT	SBR
Lane Configurations												
Traffic Volume (veh/h)	0	95	10	85	105	10	30	50	110	20	10	5
Future Volume (Veh/h)	0	95	10	85	105	10	30	50	110	20	10	5
Sign Control		Free			Free			Stop			Stop	
Grade		0%			0%			0%			0%	
Peak Hour Factor	0.92	0.92	0.92	0.92	0.92	0.92	0.92	0.92	0.92	0.92	0.92	0.92
Hourly flow rate (vph)	0	103	11	92	114	11	33	54	120	22	11	5
Pedestrians												
Lane Width (m)												
Walking Speed (m/s)												
Percent Blockage												
Right turn flare (veh)												
Median type		None			None							
Median storage veh												
Upstream signal (m)												
pX, platoon unblocked												
vC, conflicting volume	125			114			422	418	108	559	418	120
vC1, stage 1 conf vol												
vC2, stage 2 conf vol												
vCu, unblocked vol	125			114			422	418	108	559	418	120
tC, single (s)	4.1			4.1			7.1	6.5	6.2	7.1	6.5	6.2
tC, 2 stage (s)												
tF (s)	2.2			2.2			3.5	4.0	3.3	3.5	4.0	3.3
p0 queue free %	100			94			93	89	87	93	98	99
cM capacity (veh/h)	1462			1475			504	493	945	335	493	932
Direction, Lane #	EB 1	WB 1	NB 1	SB 1								
Volume Total	114	217	207	38								
Volume Left	0	92	33	22								
Volume Right	11	11	120	5								
cSH	1462	1475	686	407								
Volume to Capacity	0.00	0.06	0.30	0.09								
Queue Length 95th (m)	0.0	1.6	10.2	2.5								
Control Delay (s)	0.0	3.5	12.5	14.7								
Lane LOS		A	B	B								
Approach Delay (s)	0.0	3.5	12.5	14.7								
Approach LOS			B	B								
Intersection Summary												
Average Delay			6.8									
Intersection Capacity Utilization			35.2%		ICU Level of Service				A			
Analysis Period (min)			15									









HCM Unsignalized Intersection Capacity Analysis
201: Lublin Ave. & Wyandotte St.

PM Peak Hour
2032 Future Background Conditions

						
Movement	EBT	EBR	WBL	WBT	NBL	NBR
Lane Configurations						
Traffic Volume (veh/h)	455	25	0	315	15	0
Future Volume (Veh/h)	455	25	0	315	15	0
Sign Control	Free			Free	Stop	
Grade	0%			0%	0%	
Peak Hour Factor	0.92	0.92	0.92	0.92	0.92	0.92
Hourly flow rate (vph)	495	27	0	342	16	0
Pedestrians						
Lane Width (m)						
Walking Speed (m/s)						
Percent Blockage						
Right turn flare (veh)						
Median type	None			None		
Median storage (veh)						
Upstream signal (m)						
pX, platoon unblocked						
vC, conflicting volume			522		850	508
vC1, stage 1 conf vol						
vC2, stage 2 conf vol						
vCu, unblocked vol			522		850	508
tC, single (s)			4.1		6.4	6.2
tC, 2 stage (s)						
tF (s)			2.2		3.5	3.3
p0 queue free %			100		95	100
cM capacity (veh/h)			1044		331	565
Direction, Lane #	EB 1	WB 1	NB 1			
Volume Total	522	342	16			
Volume Left	0	0	16			
Volume Right	27	0	0			
cSH	1700	1044	331			
Volume to Capacity	0.31	0.00	0.05			
Queue Length 95th (m)	0.0	0.0	1.2			
Control Delay (s)	0.0	0.0	16.4			
Lane LOS			C			
Approach Delay (s)	0.0	0.0	16.4			
Approach LOS			C			
Intersection Summary						
Average Delay			0.3			
Intersection Capacity Utilization			35.5%	ICU Level of Service	A	
Analysis Period (min)			15			



















HCM Unsignalized Intersection Capacity Analysis
202: Icewater Ave. & Wyandotte St.

PM Peak Hour
2032 Future Background Conditions

						
Movement	EBT	EBR	WBL	WBT	NBL	NBR
Lane Configurations						
Traffic Volume (veh/h)	440	15	5	310	10	0
Future Volume (Veh/h)	440	15	5	310	10	0
Sign Control	Free			Free	Stop	
Grade	0%			0%	0%	
Peak Hour Factor	0.92	0.92	0.92	0.92	0.92	0.92
Hourly flow rate (vph)	478	16	5	337	11	0
Pedestrians						
Lane Width (m)						
Walking Speed (m/s)						
Percent Blockage						
Right turn flare (veh)						
Median type	None		None			
Median storage (veh)						
Upstream signal (m)						
pX, platoon unblocked						
vC, conflicting volume			494		833	486
vC1, stage 1 conf vol						
vC2, stage 2 conf vol						
vCu, unblocked vol			494		833	486
tC, single (s)			4.1		6.4	6.2
tC, 2 stage (s)						
tF (s)			2.2		3.5	3.3
p0 queue free %			100		97	100
cM capacity (veh/h)			1070		337	581
Direction, Lane #	EB 1	WB 1	NB 1			
Volume Total	494	342	11			
Volume Left	0	5	11			
Volume Right	16	0	0			
cSH	1700	1070	337			
Volume to Capacity	0.29	0.00	0.03			
Queue Length 95th (m)	0.0	0.1	0.8			
Control Delay (s)	0.0	0.2	16.0			
Lane LOS	A		C			
Approach Delay (s)	0.0	0.2	16.0			
Approach LOS	A		C			
Intersection Summary						
Average Delay			0.3			
Intersection Capacity Utilization			34.1%	ICU Level of Service		A
Analysis Period (min)			15			

















HCM Unsignalized Intersection Capacity Analysis
101: Florence Ave. & Wyandotte St.

Saturday Peak Hour
2032 Future Background Conditions

												
Movement	EBL	EBT	EBR	WBL	WBT	WBR	NBL	NBT	NBR	SBL	SBT	SBR
Lane Configurations												
Traffic Volume (veh/h)	20	320	40	15	265	10	35	5	15	10	5	30
Future Volume (Veh/h)	20	320	40	15	265	10	35	5	15	10	5	30
Sign Control		Free			Free			Stop			Stop	
Grade		0%			0%			0%			0%	
Peak Hour Factor	0.92	0.92	0.92	0.92	0.92	0.92	0.92	0.92	0.92	0.92	0.92	0.92
Hourly flow rate (vph)	22	348	43	16	288	11	38	5	16	11	5	33
Pedestrians												
Lane Width (m)												
Walking Speed (m/s)												
Percent Blockage												
Right turn flare (veh)												
Median type	None					None						
Median storage veh												
Upstream signal (m)												
pX, platoon unblocked												
vC, conflicting volume	299			391			769	744	370	736	760	294
vC1, stage 1 conf vol												
vC2, stage 2 conf vol												
vCu, unblocked vol	299			391			769	744	370	736	760	294
tC, single (s)	4.1			4.1			7.1	6.5	6.2	7.1	6.5	6.2
tC, 2 stage (s)												
tF (s)	2.2			2.2			3.5	4.0	3.3	3.5	4.0	3.3
p0 queue free %	98			99			87	98	98	97	98	96
cM capacity (veh/h)	1262			1168			293	332	676	315	325	746
Direction, Lane #	EB 1	EB 2	WB 1	WB 2	NB 1	SB 1						
Volume Total	22	391	16	299	59	49						
Volume Left	22	0	16	0	38	11						
Volume Right	0	43	0	11	16	33						
cSH	1262	1700	1168	1700	351	518						
Volume to Capacity	0.02	0.23	0.01	0.18	0.17	0.09						
Queue Length 95th (m)	0.4	0.0	0.3	0.0	4.8	2.5						
Control Delay (s)	7.9	0.0	8.1	0.0	17.3	12.7						
Lane LOS	A		A		C	B						
Approach Delay (s)	0.4		0.4		17.3	12.7						
Approach LOS					C	B						
Intersection Summary												
Average Delay			2.3									
Intersection Capacity Utilization			33.4%		ICU Level of Service				A			
Analysis Period (min)			15									

















HCM Unsignalized Intersection Capacity Analysis
102: Clover Ave. & Wyandotte St.

Saturday Peak Hour
2032 Future Background Conditions

												
Movement	EBL	EBT	EBR	WBL	WBT	WBR	NBL	NBT	NBR	SBL	SBT	SBR
Lane Configurations												
Traffic Volume (veh/h)	10	330	0	0	280	20	0	0	0	20	0	15
Future Volume (Veh/h)	10	330	0	0	280	20	0	0	0	20	0	15
Sign Control		Free			Free			Stop			Stop	
Grade		0%			0%			0%			0%	
Peak Hour Factor	0.92	0.92	0.92	0.92	0.92	0.92	0.92	0.92	0.92	0.92	0.92	0.92
Hourly flow rate (vph)	11	359	0	0	304	22	0	0	0	22	0	16
Pedestrians												
Lane Width (m)												
Walking Speed (m/s)												
Percent Blockage												
Right turn flare (veh)												
Median type		None			None							
Median storage veh												
Upstream signal (m)												
pX, platoon unblocked												
vC, conflicting volume	326			359			712	707	359	696	696	315
vC1, stage 1 conf vol												
vC2, stage 2 conf vol												
vCu, unblocked vol	326			359			712	707	359	696	696	315
tC, single (s)	4.1			4.1			7.1	6.5	6.2	7.1	6.5	6.2
tC, 2 stage (s)												
tF (s)	2.2			2.2			3.5	4.0	3.3	3.5	4.0	3.3
p0 queue free %	99			100			100	100	100	94	100	98
cM capacity (veh/h)	1234			1200			337	357	685	354	362	725
Direction, Lane #	EB 1	WB 1	NB 1	SB 1								
Volume Total	370	326	0	38								
Volume Left	11	0	0	22								
Volume Right	0	22	0	16								
cSH	1234	1200	1700	451								
Volume to Capacity	0.01	0.00	0.00	0.08								
Queue Length 95th (m)	0.2	0.0	0.0	2.2								
Control Delay (s)	0.3	0.0	0.0	13.7								
Lane LOS	A		A	B								
Approach Delay (s)	0.3	0.0	0.0	13.7								
Approach LOS			A	B								
Intersection Summary												
Average Delay			0.9									
Intersection Capacity Utilization			35.4%		ICU Level of Service				A			
Analysis Period (min)			15									

















HCM Unsignalized Intersection Capacity Analysis
 103: McHugh Park Driveway/Florence Ave. & McHugh St.

Saturday Peak Hour
 2032 Future Background Conditions

												
Movement	EBL	EBT	EBR	WBL	WBT	WBR	NBL	NBT	NBR	SBL	SBT	SBR
Lane Configurations												
Traffic Volume (veh/h)	95	340	0	5	335	10	10	0	5	5	0	135
Future Volume (Veh/h)	95	340	0	5	335	10	10	0	5	5	0	135
Sign Control		Free			Free			Stop			Stop	
Grade		0%			0%			0%			0%	
Peak Hour Factor	0.92	0.92	0.92	0.92	0.92	0.92	0.92	0.92	0.92	0.92	0.92	0.92
Hourly flow rate (vph)	103	370	0	5	364	11	11	0	5	5	0	147
Pedestrians												
Lane Width (m)												
Walking Speed (m/s)												
Percent Blockage												
Right turn flare (veh)												
Median type		None			None							
Median storage (veh)												
Upstream signal (m)												
pX, platoon unblocked												
vC, conflicting volume	375			370			915	961	185	776	956	188
vC1, stage 1 conf vol												
vC2, stage 2 conf vol												
vCu, unblocked vol	375			370			915	961	185	776	956	188
tC, single (s)	4.1			4.1			7.5	6.5	6.9	7.5	6.5	6.9
tC, 2 stage (s)												
tF (s)	2.2			2.2			3.5	4.0	3.3	3.5	4.0	3.3
p0 queue free %	91			100			94	100	99	98	100	82
cM capacity (veh/h)	1180			1185			174	232	826	266	233	823
Direction, Lane #	EB 1	EB 2	WB 1	WB 2	NB 1	SB 1						
Volume Total	288	185	187	193	16	152						
Volume Left	103	0	5	0	11	5						
Volume Right	0	0	0	11	5	147						
cSH	1180	1700	1185	1700	231	770						
Volume to Capacity	0.09	0.11	0.00	0.11	0.07	0.20						
Queue Length 95th (m)	2.3	0.0	0.1	0.0	1.8	5.9						
Control Delay (s)	3.5	0.0	0.3	0.0	21.7	10.8						
Lane LOS	A		A		C	B						
Approach Delay (s)	2.1		0.1		21.7	10.8						
Approach LOS					C	B						
Intersection Summary												
Average Delay			3.0									
Intersection Capacity Utilization			40.4%		ICU Level of Service				A			
Analysis Period (min)			15									









HCM Unsignalized Intersection Capacity Analysis
104: Clover Ave. & Little River Blvd.

Saturday Peak Hour
2032 Future Background Conditions

												
Movement	EBL	EBT	EBR	WBL	WBT	WBR	NBL	NBT	NBR	SBL	SBT	SBR
Lane Configurations												
Traffic Volume (veh/h)	5	90	15	60	135	15	10	50	60	15	20	0
Future Volume (Veh/h)	5	90	15	60	135	15	10	50	60	15	20	0
Sign Control		Free			Free			Stop			Stop	
Grade		0%			0%			0%			0%	
Peak Hour Factor	0.92	0.92	0.92	0.92	0.92	0.92	0.92	0.92	0.92	0.92	0.92	0.92
Hourly flow rate (vph)	5	98	16	65	147	16	11	54	65	16	22	0
Pedestrians												
Lane Width (m)												
Walking Speed (m/s)												
Percent Blockage												
Right turn flare (veh)												
Median type		None					None					
Median storage veh												
Upstream signal (m)												
pX, platoon unblocked												
vC, conflicting volume	163			114			412	409	106	493	409	155
vC1, stage 1 conf vol												
vC2, stage 2 conf vol												
vCu, unblocked vol	163			114			412	409	106	493	409	155
tC, single (s)	4.1			4.1			7.1	6.5	6.2	7.1	6.5	6.2
tC, 2 stage (s)												
tF (s)	2.2			2.2			3.5	4.0	3.3	3.5	4.0	3.3
p0 queue free %	100			96			98	89	93	96	96	100
cM capacity (veh/h)	1416			1475			513	507	948	401	507	891
Direction, Lane #												
	EB 1	WB 1	NB 1	SB 1								
Volume Total	119	228	130	38								
Volume Left	5	65	11	16								
Volume Right	16	16	65	0								
cSH	1416	1475	661	456								
Volume to Capacity	0.00	0.04	0.20	0.08								
Queue Length 95th (m)	0.1	1.1	5.8	2.2								
Control Delay (s)	0.3	2.4	11.8	13.6								
Lane LOS	A	A	B	B								
Approach Delay (s)	0.3	2.4	11.8	13.6								
Approach LOS			B	B								
Intersection Summary												
Average Delay			5.1									
Intersection Capacity Utilization			31.6%	ICU Level of Service	A							
Analysis Period (min)			15									









HCM Unsignalized Intersection Capacity Analysis
201: Lublin Ave. & Wyandotte St.

Saturday Peak Hour
2032 Future Background Conditions

						
Movement	EBT	EBR	WBL	WBT	NBL	NBR
Lane Configurations						
Traffic Volume (veh/h)	305	20	0	265	20	0
Future Volume (Veh/h)	305	20	0	265	20	0
Sign Control	Free			Free	Stop	
Grade	0%			0%	0%	
Peak Hour Factor	0.92	0.92	0.92	0.92	0.92	0.92
Hourly flow rate (vph)	332	22	0	288	22	0
Pedestrians						
Lane Width (m)						
Walking Speed (m/s)						
Percent Blockage						
Right turn flare (veh)						
Median type	None		None			
Median storage (veh)						
Upstream signal (m)						
pX, platoon unblocked						
vC, conflicting volume			354		631	343
vC1, stage 1 conf vol						
vC2, stage 2 conf vol						
vCu, unblocked vol			354		631	343
tC, single (s)			4.1		6.4	6.2
tC, 2 stage (s)						
tF (s)			2.2		3.5	3.3
p0 queue free %			100		95	100
cM capacity (veh/h)			1205		445	700
Direction, Lane #	EB 1	WB 1	NB 1			
Volume Total	354	288	22			
Volume Left	0	0	22			
Volume Right	22	0	0			
cSH	1700	1205	445			
Volume to Capacity	0.21	0.00	0.05			
Queue Length 95th (m)	0.0	0.0	1.2			
Control Delay (s)	0.0	0.0	13.5			
Lane LOS			B			
Approach Delay (s)	0.0	0.0	13.5			
Approach LOS			B			
Intersection Summary						
Average Delay			0.4			
Intersection Capacity Utilization			27.3%	ICU Level of Service		A
Analysis Period (min)			15			



















HCM Unsignalized Intersection Capacity Analysis
202: Icewater Ave. & Wyandotte St.

Saturday Peak Hour
2032 Future Background Conditions

						
Movement	EBT	EBR	WBL	WBT	NBL	NBR
Lane Configurations						
Traffic Volume (veh/h)	295	15	5	255	10	5
Future Volume (Veh/h)	295	15	5	255	10	5
Sign Control	Free			Free	Stop	
Grade	0%			0%	0%	
Peak Hour Factor	0.92	0.92	0.92	0.92	0.92	0.92
Hourly flow rate (vph)	321	16	5	277	11	5
Pedestrians						
Lane Width (m)						
Walking Speed (m/s)						
Percent Blockage						
Right turn flare (veh)						
Median type	None		None			
Median storage (veh)						
Upstream signal (m)						
pX, platoon unblocked						
vC, conflicting volume			337		616	329
vC1, stage 1 conf vol						
vC2, stage 2 conf vol						
vCu, unblocked vol			337		616	329
tC, single (s)			4.1		6.4	6.2
tC, 2 stage (s)						
tF (s)			2.2		3.5	3.3
p0 queue free %			100		98	99
cM capacity (veh/h)			1222		452	712
Direction, Lane #	EB 1	WB 1	NB 1			
Volume Total	337	282	16			
Volume Left	0	5	11			
Volume Right	16	0	5			
cSH	1700	1222	510			
Volume to Capacity	0.20	0.00	0.03			
Queue Length 95th (m)	0.0	0.1	0.8			
Control Delay (s)	0.0	0.2	12.3			
Lane LOS	A		B			
Approach Delay (s)	0.0	0.2	12.3			
Approach LOS	A		B			
Intersection Summary						
Average Delay			0.4			
Intersection Capacity Utilization			27.4%	ICU Level of Service		A
Analysis Period (min)			15			



















HCM Unsignalized Intersection Capacity Analysis
101: Florence Ave. & Wyandotte St.

AM Peak Hour
2027 Total Future Conditions

												
Movement	EBL	EBT	EBR	WBL	WBT	WBR	NBL	NBT	NBR	SBL	SBT	SBR
Lane Configurations												
Traffic Volume (veh/h)	15	355	20	5	455	0	45	45	15	10	25	25
Future Volume (Veh/h)	15	355	20	5	455	0	45	45	15	10	25	25
Sign Control		Free			Free			Stop			Stop	
Grade		0%			0%			0%			0%	
Peak Hour Factor	0.92	0.92	0.92	0.92	0.92	0.92	0.92	0.92	0.92	0.92	0.92	0.92
Hourly flow rate (vph)	16	386	22	5	495	0	49	49	16	11	27	27
Pedestrians												
Lane Width (m)												
Walking Speed (m/s)												
Percent Blockage												
Right turn flare (veh)												
Median type		None			None							
Median storage veh												
Upstream signal (m)												
pX, platoon unblocked												
vC, conflicting volume	495			408			974	934	397	964	945	495
vC1, stage 1 conf vol												
vC2, stage 2 conf vol												
vCu, unblocked vol	495			408			974	934	397	964	945	495
tC, single (s)	4.1			4.1			7.1	6.5	6.2	7.1	6.5	6.2
tC, 2 stage (s)												
tF (s)	2.2			2.2			3.5	4.0	3.3	3.5	4.0	3.3
p0 queue free %	99			100			75	81	98	94	89	95
cM capacity (veh/h)	1069			1151			199	261	652	193	257	575
Direction, Lane #	EB 1	EB 2	WB 1	WB 2	NB 1	SB 1						
Volume Total	16	408	5	495	114	65						
Volume Left	16	0	5	0	49	11						
Volume Right	0	22	0	0	16	27						
cSH	1069	1700	1151	1700	249	311						
Volume to Capacity	0.01	0.24	0.00	0.29	0.46	0.21						
Queue Length 95th (m)	0.4	0.0	0.1	0.0	17.9	6.2						
Control Delay (s)	8.4	0.0	8.1	0.0	31.1	19.6						
Lane LOS	A		A		D	C						
Approach Delay (s)	0.3		0.1		31.1	19.6						
Approach LOS					D	C						
Intersection Summary												
Average Delay			4.5									
Intersection Capacity Utilization			43.0%		ICU Level of Service				A			
Analysis Period (min)			15									

















HCM Unsignalized Intersection Capacity Analysis
102: Clover Ave. & Wyandotte St.

AM Peak Hour
2027 Total Future Conditions

												
Movement	EBL	EBT	EBR	WBL	WBT	WBR	NBL	NBT	NBR	SBL	SBT	SBR
Lane Configurations												
Traffic Volume (veh/h)	5	355	15	0	400	25	40	120	10	15	65	5
Future Volume (Veh/h)	5	355	15	0	400	25	40	120	10	15	65	5
Sign Control	Free			Free			Stop			Stop		
Grade	0%			0%			0%			0%		
Peak Hour Factor	0.92	0.92	0.92	0.92	0.92	0.92	0.92	0.92	0.92	0.92	0.92	0.92
Hourly flow rate (vph)	5	386	16	0	435	27	43	130	11	16	71	5
Pedestrians												
Lane Width (m)												
Walking Speed (m/s)												
Percent Blockage												
Right turn flare (veh)												
Median type	None					None						
Median storage (veh)												
Upstream signal (m)												
pX, platoon unblocked												
vC, conflicting volume	462			402			880	866	394	920	860	448
vC1, stage 1 conf vol												
vC2, stage 2 conf vol												
vCu, unblocked vol	462			402			880	866	394	920	860	448
tC, single (s)	4.1			4.1			7.1	6.5	6.2	7.1	6.5	6.2
tC, 2 stage (s)												
tF (s)	2.2			2.2			3.5	4.0	3.3	3.5	4.0	3.3
p0 queue free %	100			100			80	55	98	90	76	99
cM capacity (veh/h)	1099			1157			215	290	655	160	292	610
Direction, Lane #	EB 1	EB 2	WB 1	WB 2	NB 1	SB 1						
Volume Total	5	402	0	462	184	92						
Volume Left	5	0	0	0	43	16						
Volume Right	0	16	0	27	11	5						
cSH	1099	1700	1700	1700	277	262						
Volume to Capacity	0.00	0.24	0.00	0.27	0.67	0.35						
Queue Length 95th (m)	0.1	0.0	0.0	0.0	34.7	12.1						
Control Delay (s)	8.3	0.0	0.0	0.0	40.5	26.0						
Lane LOS	A				E	D						
Approach Delay (s)	0.1		0.0		40.5	26.0						
Approach LOS					E	D						
Intersection Summary												
Average Delay			8.6									
Intersection Capacity Utilization			42.9%	ICU Level of Service				A				
Analysis Period (min)			15									

















HCM Unsignalized Intersection Capacity Analysis
 103: McHugh Park Driveway/Florence Ave. & McHugh St.

AM Peak Hour
 2027 Total Future Conditions

												
Movement	EBL	EBT	EBR	WBL	WBT	WBR	NBL	NBT	NBR	SBL	SBT	SBR
Lane Configurations												
Traffic Volume (veh/h)	45	385	10	5	485	40	0	0	5	20	0	180
Future Volume (Veh/h)	45	385	10	5	485	40	0	0	5	20	0	180
Sign Control		Free			Free			Stop			Stop	
Grade		0%			0%			0%			0%	
Peak Hour Factor	0.92	0.92	0.92	0.92	0.92	0.92	0.92	0.92	0.92	0.92	0.92	0.92
Hourly flow rate (vph)	49	418	11	5	527	43	0	0	5	22	0	196
Pedestrians												
Lane Width (m)												
Walking Speed (m/s)												
Percent Blockage												
Right turn flare (veh)												
Median type		None			None							
Median storage veh												
Upstream signal (m)												
pX, platoon unblocked												
vC, conflicting volume	570			429			991	1102	214	870	1086	285
vC1, stage 1 conf vol												
vC2, stage 2 conf vol												
vCu, unblocked vol	570			429			991	1102	214	870	1086	285
tC, single (s)	4.1			4.1			7.5	6.5	6.9	7.5	6.5	6.9
tC, 2 stage (s)												
tF (s)	2.2			2.2			3.5	4.0	3.3	3.5	4.0	3.3
p0 queue free %	95			100			100	100	99	91	100	72
cM capacity (veh/h)	999			1127			139	199	790	234	204	712
Direction, Lane #	EB 1	EB 2	WB 1	WB 2	NB 1	SB 1						
Volume Total	258	220	268	306	5	218						
Volume Left	49	0	5	0	0	22						
Volume Right	0	11	0	43	5	196						
cSH	999	1700	1127	1700	790	590						
Volume to Capacity	0.05	0.13	0.00	0.18	0.01	0.37						
Queue Length 95th (m)	1.2	0.0	0.1	0.0	0.2	13.6						
Control Delay (s)	2.1	0.0	0.2	0.0	9.6	14.6						
Lane LOS	A		A		A	B						
Approach Delay (s)	1.1		0.1		9.6	14.6						
Approach LOS					A	B						
Intersection Summary												
Average Delay			3.0									
Intersection Capacity Utilization			56.0%		ICU Level of Service				B			
Analysis Period (min)			15									

















HCM Unsignalized Intersection Capacity Analysis
104: Clover Ave. & Little River Blvd.

AM Peak Hour
2027 Total Future Conditions

												
Movement	EBL	EBT	EBR	WBL	WBT	WBR	NBL	NBT	NBR	SBL	SBT	SBR
Lane Configurations												
Traffic Volume (veh/h)	0	60	30	145	125	5	10	150	60	15	100	5
Future Volume (Veh/h)	0	60	30	145	125	5	10	150	60	15	100	5
Sign Control		Free			Free			Stop			Stop	
Grade		0%			0%			0%			0%	
Peak Hour Factor	0.92	0.92	0.92	0.92	0.92	0.92	0.92	0.92	0.92	0.92	0.92	0.92
Hourly flow rate (vph)	0	65	33	158	136	5	11	163	65	16	109	5
Pedestrians												
Lane Width (m)												
Walking Speed (m/s)												
Percent Blockage												
Right turn flare (veh)												
Median type		None			None							
Median storage (veh)												
Upstream signal (m)												
pX, platoon unblocked												
vC, conflicting volume	141			98			596	538	82	682	552	138
vC1, stage 1 conf vol												
vC2, stage 2 conf vol												
vCu, unblocked vol	141			98			596	538	82	682	552	138
tC, single (s)	4.1			4.1			7.1	6.5	6.2	7.1	6.5	6.2
tC, 2 stage (s)												
tF (s)	2.2			2.2			3.5	4.0	3.3	3.5	4.0	3.3
p0 queue free %	100			89			96	59	93	93	72	99
cM capacity (veh/h)	1442			1495			300	402	978	215	395	910
Direction, Lane #	EB 1	WB 1	NB 1	SB 1								
Volume Total	98	299	239	130								
Volume Left	0	158	11	16								
Volume Right	33	5	65	5								
cSH	1442	1495	470	365								
Volume to Capacity	0.00	0.11	0.51	0.36								
Queue Length 95th (m)	0.0	2.8	22.6	12.6								
Control Delay (s)	0.0	4.5	20.3	20.2								
Lane LOS		A	C	C								
Approach Delay (s)	0.0	4.5	20.3	20.2								
Approach LOS			C	C								
Intersection Summary												
Average Delay			11.5									
Intersection Capacity Utilization			41.6%		ICU Level of Service				A			
Analysis Period (min)			15									









HCM Unsignalized Intersection Capacity Analysis
201: Lublin Ave./Phase 7 Drive & Wyandotte St.

AM Peak Hour
2027 Total Future Conditions

												
Movement	EBL	EBT	EBR	WBL	WBT	WBR	NBL	NBT	NBR	SBL	SBT	SBR
Lane Configurations												
Traffic Volume (veh/h)	20	355	5	0	350	5	20	5	5	10	15	30
Future Volume (Veh/h)	20	355	5	0	350	5	20	5	5	10	15	30
Sign Control		Free			Free			Stop			Stop	
Grade		0%			0%			0%			0%	
Peak Hour Factor	0.92	0.92	0.92	0.92	0.92	0.92	0.92	0.92	0.92	0.92	0.92	0.92
Hourly flow rate (vph)	22	386	5	0	380	5	22	5	5	11	16	33
Pedestrians												
Lane Width (m)												
Walking Speed (m/s)												
Percent Blockage												
Right turn flare (veh)												
Median type		None			None							
Median storage veh												
Upstream signal (m)												
pX, platoon unblocked												
vC, conflicting volume	385			391			856	818	388	822	818	382
vC1, stage 1 conf vol												
vC2, stage 2 conf vol												
vCu, unblocked vol	385			391			856	818	388	822	818	382
tC, single (s)	4.1			4.1			7.1	6.5	6.2	7.1	6.5	6.2
tC, 2 stage (s)												
tF (s)	2.2			2.2			3.5	4.0	3.3	3.5	4.0	3.3
p0 queue free %	98			100			91	98	99	96	95	95
cM capacity (veh/h)	1173			1168			250	305	660	283	305	665
Direction, Lane #	EB 1	WB 1	NB 1	SB 1								
Volume Total	413	385	32	60								
Volume Left	22	0	22	11								
Volume Right	5	5	5	33								
cSH	1173	1168	286	426								
Volume to Capacity	0.02	0.00	0.11	0.14								
Queue Length 95th (m)	0.5	0.0	3.0	3.9								
Control Delay (s)	0.6	0.0	19.2	14.8								
Lane LOS	A		C	B								
Approach Delay (s)	0.6	0.0	19.2	14.8								
Approach LOS			C	B								
Intersection Summary												
Average Delay			2.0									
Intersection Capacity Utilization			46.8%		ICU Level of Service				A			
Analysis Period (min)			15									

















HCM Unsignalized Intersection Capacity Analysis
202: Icewater Ave. & Wyandotte St.

AM Peak Hour
2027 Total Future Conditions

						
Movement	EBT	EBR	WBL	WBT	NBL	NBR
Lane Configurations						
Traffic Volume (veh/h)	360	5	0	340	15	5
Future Volume (Veh/h)	360	5	0	340	15	5
Sign Control	Free			Free	Stop	
Grade	0%			0%	0%	
Peak Hour Factor	0.92	0.92	0.92	0.92	0.92	0.92
Hourly flow rate (vph)	391	5	0	370	16	5
Pedestrians						
Lane Width (m)						
Walking Speed (m/s)						
Percent Blockage						
Right turn flare (veh)						
Median type	None		None			
Median storage (veh)						
Upstream signal (m)						
pX, platoon unblocked						
vC, conflicting volume			396		764	394
vC1, stage 1 conf vol						
vC2, stage 2 conf vol						
vCu, unblocked vol			396		764	394
tC, single (s)			4.1		6.4	6.2
tC, 2 stage (s)						
tF (s)			2.2		3.5	3.3
p0 queue free %			100		96	99
cM capacity (veh/h)			1163		372	655
Direction, Lane #	EB 1	WB 1	NB 1			
Volume Total	396	370	21			
Volume Left	0	0	16			
Volume Right	5	0	5			
cSH	1700	1163	415			
Volume to Capacity	0.23	0.00	0.05			
Queue Length 95th (m)	0.0	0.0	1.3			
Control Delay (s)	0.0	0.0	14.1			
Lane LOS			B			
Approach Delay (s)	0.0	0.0	14.1			
Approach LOS			B			
Intersection Summary						
Average Delay			0.4			
Intersection Capacity Utilization			29.3%	ICU Level of Service		A
Analysis Period (min)			15			









HCM Unsignalized Intersection Capacity Analysis
 301: Clover Ave. & Thunderbay Ave./Copernicus St.

AM Peak Hour
 2027 Total Future Conditions

												
Movement	EBL	EBT	EBR	WBL	WBT	WBR	NBL	NBT	NBR	SBL	SBT	SBR
Lane Configurations												
Traffic Volume (veh/h)	5	0	5	0	0	10	5	120	20	5	80	0
Future Volume (Veh/h)	5	0	5	0	0	10	5	120	20	5	80	0
Sign Control	Stop			Stop			Free			Free		
Grade	0%			0%			0%			0%		
Peak Hour Factor	0.92	0.92	0.92	0.92	0.92	0.92	0.92	0.92	0.92	0.92	0.92	0.92
Hourly flow rate (vph)	5	0	5	0	0	11	5	130	22	5	87	0
Pedestrians												
Lane Width (m)												
Walking Speed (m/s)												
Percent Blockage												
Right turn flare (veh)												
Median type												
Median storage veh												
Upstream signal (m)												
pX, platoon unblocked												
vC, conflicting volume	259	259	87	253	248	141	87			152		
vC1, stage 1 conf vol												
vC2, stage 2 conf vol												
vCu, unblocked vol	259	259	87	253	248	141	87			152		
tC, single (s)	7.1	6.5	6.2	7.1	6.5	6.2	4.1			4.1		
tC, 2 stage (s)												
tF (s)	3.5	4.0	3.3	3.5	4.0	3.3	2.2			2.2		
p0 queue free %	99	100	99	100	100	99	100			100		
cM capacity (veh/h)	682	641	971	693	650	907	1509			1429		
Direction, Lane #	EB 1	WB 1	NB 1	SB 1								
Volume Total	10	11	157	92								
Volume Left	5	0	5	5								
Volume Right	5	11	22	0								
cSH	801	907	1509	1429								
Volume to Capacity	0.01	0.01	0.00	0.00								
Queue Length 95th (m)	0.3	0.3	0.1	0.1								
Control Delay (s)	9.5	9.0	0.3	0.4								
Lane LOS	A	A	A	A								
Approach Delay (s)	9.5	9.0	0.3	0.4								
Approach LOS	A	A										
Intersection Summary												
Average Delay			1.0									
Intersection Capacity Utilization			20.8%		ICU Level of Service					A		
Analysis Period (min)			15									



















HCM Unsignalized Intersection Capacity Analysis
 302: Florence Ave. & Beverly Glen St.

AM Peak Hour
 2027 Total Future Conditions

						
Movement	WBL	WBR	NBT	NBR	SBL	SBT
Lane Configurations						
Traffic Volume (veh/h)	120	0	45	45	0	40
Future Volume (Veh/h)	120	0	45	45	0	40
Sign Control	Stop		Free		Free	
Grade	0%		0%		0%	
Peak Hour Factor	0.92	0.92	0.92	0.92	0.92	0.92
Hourly flow rate (vph)	130	0	49	49	0	43
Pedestrians						
Lane Width (m)						
Walking Speed (m/s)						
Percent Blockage						
Right turn flare (veh)						
Median type	None			None		
Median storage (veh)						
Upstream signal (m)						
pX, platoon unblocked						
vC, conflicting volume	116	74			98	
vC1, stage 1 conf vol						
vC2, stage 2 conf vol						
vCu, unblocked vol	116	74			98	
tC, single (s)	6.4	6.2			4.1	
tC, 2 stage (s)						
tF (s)	3.5	3.3			2.2	
p0 queue free %	85	100			100	
cM capacity (veh/h)	880	988			1495	
Direction, Lane #	WB 1	NB 1	SB 1			
Volume Total	130	98	43			
Volume Left	130	0	0			
Volume Right	0	49	0			
cSH	880	1700	1495			
Volume to Capacity	0.15	0.06	0.00			
Queue Length 95th (m)	4.1	0.0	0.0			
Control Delay (s)	9.8	0.0	0.0			
Lane LOS	A					
Approach Delay (s)	9.8	0.0	0.0			
Approach LOS	A					
Intersection Summary						
Average Delay			4.7			
Intersection Capacity Utilization			18.4%	ICU Level of Service		A
Analysis Period (min)			15			



















HCM Unsignalized Intersection Capacity Analysis
101: Florence Ave. & Wyandotte St.

PM Peak Hour
2027 Total Future Conditions

												
Movement	EBL	EBT	EBR	WBL	WBT	WBR	NBL	NBT	NBR	SBL	SBT	SBR
Lane Configurations												
Traffic Volume (veh/h)	25	520	45	15	330	15	35	30	10	15	60	20
Future Volume (Veh/h)	25	520	45	15	330	15	35	30	10	15	60	20
Sign Control		Free			Free			Stop			Stop	
Grade		0%			0%			0%			0%	
Peak Hour Factor	0.92	0.92	0.92	0.92	0.92	0.92	0.92	0.92	0.92	0.92	0.92	0.92
Hourly flow rate (vph)	27	565	49	16	359	16	38	33	11	16	65	22
Pedestrians												
Lane Width (m)												
Walking Speed (m/s)												
Percent Blockage												
Right turn flare (veh)												
Median type		None			None							
Median storage veh												
Upstream signal (m)												
pX, platoon unblocked												
vC, conflicting volume	375			614			1089	1050	590	1046	1067	367
vC1, stage 1 conf vol												
vC2, stage 2 conf vol												
vCu, unblocked vol	375			614			1089	1050	590	1046	1067	367
tC, single (s)	4.1			4.1			7.1	6.5	6.2	7.1	6.5	6.2
tC, 2 stage (s)												
tF (s)	2.2			2.2			3.5	4.0	3.3	3.5	4.0	3.3
p0 queue free %	98			98			73	85	98	91	70	97
cM capacity (veh/h)	1183			965			139	218	508	173	213	678
Direction, Lane #	EB 1	EB 2	WB 1	WB 2	NB 1	SB 1						
Volume Total	27	614	16	375	82	103						
Volume Left	27	0	16	0	38	16						
Volume Right	0	49	0	16	11	22						
cSH	1183	1700	965	1700	183	240						
Volume to Capacity	0.02	0.36	0.02	0.22	0.45	0.43						
Queue Length 95th (m)	0.6	0.0	0.4	0.0	16.7	16.2						
Control Delay (s)	8.1	0.0	8.8	0.0	39.6	30.8						
Lane LOS	A		A		E	D						
Approach Delay (s)	0.3		0.4		39.6	30.8						
Approach LOS					E	D						
Intersection Summary												
Average Delay			5.6									
Intersection Capacity Utilization			46.5%		ICU Level of Service				A			
Analysis Period (min)			15									

















HCM Unsignalized Intersection Capacity Analysis
102: Clover Ave. & Wyandotte St.

PM Peak Hour
2027 Total Future Conditions

												
Movement	EBL	EBT	EBR	WBL	WBT	WBR	NBL	NBT	NBR	SBL	SBT	SBR
Lane Configurations												
Traffic Volume (veh/h)	10	485	40	5	325	20	30	90	10	20	155	5
Future Volume (Veh/h)	10	485	40	5	325	20	30	90	10	20	155	5
Sign Control		Free			Free			Stop			Stop	
Grade		0%			0%			0%			0%	
Peak Hour Factor	0.92	0.92	0.92	0.92	0.92	0.92	0.92	0.92	0.92	0.92	0.92	0.92
Hourly flow rate (vph)	11	527	43	5	353	22	33	98	11	22	168	5
Pedestrians												
Lane Width (m)												
Walking Speed (m/s)												
Percent Blockage												
Right turn flare (veh)												
Median type		None			None							
Median storage veh												
Upstream signal (m)												
pX, platoon unblocked												
vC, conflicting volume	375			570			1022	956	548	983	966	364
vC1, stage 1 conf vol												
vC2, stage 2 conf vol												
vCu, unblocked vol	375			570			1022	956	548	983	966	364
tC, single (s)	4.1			4.1			7.1	6.5	6.2	7.1	6.5	6.2
tC, 2 stage (s)												
tF (s)	2.2			2.2			3.5	4.0	3.3	3.5	4.0	3.3
p0 queue free %	99			100			66	61	98	86	33	99
cM capacity (veh/h)	1183			1002			97	255	536	155	251	681
Direction, Lane #	EB 1	EB 2	WB 1	WB 2	NB 1	SB 1						
Volume Total	11	570	5	375	142	195						
Volume Left	11	0	5	0	33	22						
Volume Right	0	43	0	22	11	5						
cSH	1183	1700	1002	1700	190	238						
Volume to Capacity	0.01	0.34	0.00	0.22	0.75	0.82						
Queue Length 95th (m)	0.2	0.0	0.1	0.0	39.0	50.2						
Control Delay (s)	8.1	0.0	8.6	0.0	64.8	64.5						
Lane LOS	A		A		F	F						
Approach Delay (s)	0.2		0.1		64.8	64.5						
Approach LOS					F	F						
Intersection Summary												
Average Delay			16.9									
Intersection Capacity Utilization			47.1%		ICU Level of Service				A			
Analysis Period (min)			15									

















HCM Unsignalized Intersection Capacity Analysis
 103: McHugh Park Driveway/Florence Ave. & McHugh St.

PM Peak Hour
 2027 Total Future Conditions

												
Movement	EBL	EBT	EBR	WBL	WBT	WBR	NBL	NBT	NBR	SBL	SBT	SBR
Lane Configurations												
Traffic Volume (veh/h)	145	470	10	5	450	30	5	0	0	55	0	145
Future Volume (Veh/h)	145	470	10	5	450	30	5	0	0	55	0	145
Sign Control		Free			Free			Stop			Stop	
Grade		0%			0%			0%			0%	
Peak Hour Factor	0.92	0.92	0.92	0.92	0.92	0.92	0.92	0.92	0.92	0.92	0.92	0.92
Hourly flow rate (vph)	158	511	11	5	489	33	5	0	0	60	0	158
Pedestrians												
Lane Width (m)												
Walking Speed (m/s)												
Percent Blockage												
Right turn flare (veh)												
Median type		None			None							
Median storage veh												
Upstream signal (m)												
pX, platoon unblocked												
vC, conflicting volume	522			522			1245	1364	261	1087	1354	261
vC1, stage 1 conf vol												
vC2, stage 2 conf vol												
vCu, unblocked vol	522			522			1245	1364	261	1087	1354	261
tC, single (s)	4.1			4.1			7.5	6.5	6.9	7.5	6.5	6.9
tC, 2 stage (s)												
tF (s)	2.2			2.2			3.5	4.0	3.3	3.5	4.0	3.3
p0 queue free %	85			100			94	100	100	60	100	79
cM capacity (veh/h)	1041			1041			90	123	738	150	125	738
Direction, Lane #	EB 1	EB 2	WB 1	WB 2	NB 1	SB 1						
Volume Total	414	266	250	278	5	218						
Volume Left	158	0	5	0	5	60						
Volume Right	0	11	0	33	0	158						
cSH	1041	1700	1041	1700	90	355						
Volume to Capacity	0.15	0.16	0.00	0.16	0.06	0.61						
Queue Length 95th (m)	4.3	0.0	0.1	0.0	1.4	31.1						
Control Delay (s)	4.5	0.0	0.2	0.0	47.3	30.0						
Lane LOS	A		A		E	D						
Approach Delay (s)	2.7		0.1		47.3	30.0						
Approach LOS					E	D						
Intersection Summary												
Average Delay			6.1									
Intersection Capacity Utilization			51.9%		ICU Level of Service				A			
Analysis Period (min)			15									

















HCM Unsignalized Intersection Capacity Analysis
104: Clover Ave. & Little River Blvd.

PM Peak Hour
2027 Total Future Conditions

												
Movement	EBL	EBT	EBR	WBL	WBT	WBR	NBL	NBT	NBR	SBL	SBT	SBR
Lane Configurations												
Traffic Volume (veh/h)	0	90	10	95	115	10	25	190	105	20	170	5
Future Volume (Veh/h)	0	90	10	95	115	10	25	190	105	20	170	5
Sign Control		Free			Free			Stop			Stop	
Grade		0%			0%			0%			0%	
Peak Hour Factor	0.92	0.92	0.92	0.92	0.92	0.92	0.92	0.92	0.92	0.92	0.92	0.92
Hourly flow rate (vph)	0	98	11	103	125	11	27	207	114	22	185	5
Pedestrians												
Lane Width (m)												
Walking Speed (m/s)												
Percent Blockage												
Right turn flare (veh)												
Median type		None			None							
Median storage veh												
Upstream signal (m)												
pX, platoon unblocked												
vC, conflicting volume	136			109			538	446	104	658	446	130
vC1, stage 1 conf vol												
vC2, stage 2 conf vol												
vCu, unblocked vol	136			109			538	446	104	658	446	130
tC, single (s)	4.1			4.1			7.1	6.5	6.2	7.1	6.5	6.2
tC, 2 stage (s)												
tF (s)	2.2			2.2			3.5	4.0	3.3	3.5	4.0	3.3
p0 queue free %	100			93			91	56	88	89	61	99
cM capacity (veh/h)	1448			1481			298	472	951	208	472	919
Direction, Lane #	EB 1	WB 1	NB 1	SB 1								
Volume Total	109	239	348	212								
Volume Left	0	103	27	22								
Volume Right	11	11	114	5								
cSH	1448	1481	536	421								
Volume to Capacity	0.00	0.07	0.65	0.50								
Queue Length 95th (m)	0.0	1.8	37.0	22.0								
Control Delay (s)	0.0	3.6	23.3	21.9								
Lane LOS		A	C	C								
Approach Delay (s)	0.0	3.6	23.3	21.9								
Approach LOS			C	C								
Intersection Summary												
Average Delay			15.0									
Intersection Capacity Utilization			47.3%		ICU Level of Service				A			
Analysis Period (min)			15									











HCM Unsignalized Intersection Capacity Analysis
201: Lublin Ave./Phase 7 Drive & Wyandotte St.

PM Peak Hour
2027 Total Future Conditions

												
Movement	EBL	EBT	EBR	WBL	WBT	WBR	NBL	NBT	NBR	SBL	SBT	SBR
Lane Configurations												
Traffic Volume (veh/h)	35	440	15	5	305	10	5	15	5	5	15	25
Future Volume (Veh/h)	35	440	15	5	305	10	5	15	5	5	15	25
Sign Control		Free			Free			Stop			Stop	
Grade		0%			0%			0%			0%	
Peak Hour Factor	0.92	0.92	0.92	0.92	0.92	0.92	0.92	0.92	0.92	0.92	0.92	0.92
Hourly flow rate (vph)	38	478	16	5	332	11	5	16	5	5	16	27
Pedestrians												
Lane Width (m)												
Walking Speed (m/s)												
Percent Blockage												
Right turn flare (veh)												
Median type		None			None							
Median storage veh												
Upstream signal (m)												
pX, platoon unblocked												
vC, conflicting volume	343			494			944	915	486	922	918	338
vC1, stage 1 conf vol												
vC2, stage 2 conf vol												
vCu, unblocked vol	343			494			944	915	486	922	918	338
tC, single (s)	4.1			4.1			7.1	6.5	6.2	7.1	6.5	6.2
tC, 2 stage (s)												
tF (s)	2.2			2.2			3.5	4.0	3.3	3.5	4.0	3.3
p0 queue free %	97			100			98	94	99	98	94	96
cM capacity (veh/h)	1216			1070			216	263	581	230	262	705
Direction, Lane #	EB 1	WB 1	NB 1	SB 1								
Volume Total	532	348	26	48								
Volume Left	38	5	5	5								
Volume Right	16	11	5	27								
cSH	1216	1070	281	396								
Volume to Capacity	0.03	0.00	0.09	0.12								
Queue Length 95th (m)	0.8	0.1	2.4	3.3								
Control Delay (s)	0.9	0.2	19.1	15.3								
Lane LOS	A	A	C	C								
Approach Delay (s)	0.9	0.2	19.1	15.3								
Approach LOS			C	C								
Intersection Summary												
Average Delay			1.9									
Intersection Capacity Utilization			54.2%		ICU Level of Service				A			
Analysis Period (min)			15									

















HCM Unsignalized Intersection Capacity Analysis
202: Icewater Ave. & Wyandotte St.

PM Peak Hour
2027 Total Future Conditions

						
Movement	EBT	EBR	WBL	WBT	NBL	NBR
Lane Configurations						
Traffic Volume (veh/h)	435	15	5	310	10	0
Future Volume (Veh/h)	435	15	5	310	10	0
Sign Control	Free			Free	Stop	
Grade	0%			0%	0%	
Peak Hour Factor	0.92	0.92	0.92	0.92	0.92	0.92
Hourly flow rate (vph)	473	16	5	337	11	0
Pedestrians						
Lane Width (m)						
Walking Speed (m/s)						
Percent Blockage						
Right turn flare (veh)						
Median type	None		None			
Median storage (veh)						
Upstream signal (m)						
pX, platoon unblocked						
vC, conflicting volume			489		828	481
vC1, stage 1 conf vol						
vC2, stage 2 conf vol						
vCu, unblocked vol			489		828	481
tC, single (s)			4.1		6.4	6.2
tC, 2 stage (s)						
tF (s)			2.2		3.5	3.3
p0 queue free %			100		97	100
cM capacity (veh/h)			1074		339	585
Direction, Lane #	EB 1	WB 1	NB 1			
Volume Total	489	342	11			
Volume Left	0	5	11			
Volume Right	16	0	0			
cSH	1700	1074	339			
Volume to Capacity	0.29	0.00	0.03			
Queue Length 95th (m)	0.0	0.1	0.8			
Control Delay (s)	0.0	0.2	16.0			
Lane LOS	A		C			
Approach Delay (s)	0.0	0.2	16.0			
Approach LOS	A		C			
Intersection Summary						
Average Delay			0.3			
Intersection Capacity Utilization			33.8%	ICU Level of Service		A
Analysis Period (min)			15			

HCM Unsignalized Intersection Capacity Analysis
301: Clover Ave. & Thunderbay Ave./Copernicus St.

PM Peak Hour
2027 Total Future Conditions

												
Movement	EBL	EBT	EBR	WBL	WBT	WBR	NBL	NBT	NBR	SBL	SBT	SBR
Lane Configurations												
Traffic Volume (veh/h)	5	0	5	5	0	5	5	110	50	15	160	5
Future Volume (Veh/h)	5	0	5	5	0	5	5	110	50	15	160	5
Sign Control		Stop			Stop			Free			Free	
Grade		0%			0%			0%			0%	
Peak Hour Factor	0.92	0.92	0.92	0.92	0.92	0.92	0.92	0.92	0.92	0.92	0.92	0.92
Hourly flow rate (vph)	5	0	5	5	0	5	5	120	54	16	174	5
Pedestrians												
Lane Width (m)												
Walking Speed (m/s)												
Percent Blockage												
Right turn flare (veh)												
Median type												
								None			None	
Median storage veh												
Upstream signal (m)												
pX, platoon unblocked												
vC, conflicting volume	370	392	176	370	368	147	179			174		
vC1, stage 1 conf vol												
vC2, stage 2 conf vol												
vCu, unblocked vol	370	392	176	370	368	147	179			174		
tC, single (s)	7.1	6.5	6.2	7.1	6.5	6.2	4.1			4.1		
tC, 2 stage (s)												
tF (s)	3.5	4.0	3.3	3.5	4.0	3.3	2.2			2.2		
p0 queue free %	99	100	99	99	100	99	100			99		
cM capacity (veh/h)	576	535	867	576	553	900	1397			1403		
Direction, Lane #												
	EB 1	WB 1	NB 1	SB 1								
Volume Total	10	10	179	195								
Volume Left	5	5	5	16								
Volume Right	5	5	54	5								
cSH	692	703	1397	1403								
Volume to Capacity	0.01	0.01	0.00	0.01								
Queue Length 95th (m)	0.4	0.3	0.1	0.3								
Control Delay (s)	10.3	10.2	0.2	0.7								
Lane LOS	B	B	A	A								
Approach Delay (s)	10.3	10.2	0.2	0.7								
Approach LOS	B	B										
Intersection Summary												
Average Delay			1.0									
Intersection Capacity Utilization			25.5%		ICU Level of Service					A		
Analysis Period (min)			15									

HCM Unsignalized Intersection Capacity Analysis
 302: Florence Ave. & Beverly Glen St.



















PM Peak Hour
 2027 Total Future Conditions



Movement	WBL	WBR	NBT	NBR	SBL	SBT
Lane Configurations						
Traffic Volume (veh/h)	100	0	45	135	0	65
Future Volume (Veh/h)	100	0	45	135	0	65
Sign Control	Stop		Free		Free	
Grade	0%		0%		0%	
Peak Hour Factor	0.92	0.92	0.92	0.92	0.92	0.92
Hourly flow rate (vph)	109	0	49	147	0	71
Pedestrians						
Lane Width (m)						
Walking Speed (m/s)						
Percent Blockage						
Right turn flare (veh)						
Median type	None			None		
Median storage (veh)						
Upstream signal (m)						
pX, platoon unblocked						
vC, conflicting volume	194	122			196	
vC1, stage 1 conf vol						
vC2, stage 2 conf vol						
vCu, unblocked vol	194	122			196	
tC, single (s)	6.4	6.2			4.1	
tC, 2 stage (s)						
tF (s)	3.5	3.3			2.2	
p0 queue free %	86	100			100	
cM capacity (veh/h)	795	929			1377	
Direction, Lane #	WB 1	NB 1	SB 1			
Volume Total	109	196	71			
Volume Left	109	0	0			
Volume Right	0	147	0			
cSH	795	1700	1377			
Volume to Capacity	0.14	0.12	0.00			
Queue Length 95th (m)	3.8	0.0	0.0			
Control Delay (s)	10.2	0.0	0.0			
Lane LOS	B					
Approach Delay (s)	10.2	0.0	0.0			
Approach LOS	B					
Intersection Summary						
Average Delay			3.0			
Intersection Capacity Utilization			22.9%		ICU Level of Service	A
Analysis Period (min)			15			



















HCM Unsignalized Intersection Capacity Analysis
101: Florence Ave. & Wyandotte St.

Saturday Peak Hour
2027 Total Future Conditions

												
Movement	EBL	EBT	EBR	WBL	WBT	WBR	NBL	NBT	NBR	SBL	SBT	SBR
Lane Configurations												
Traffic Volume (veh/h)	20	370	45	15	305	10	40	30	15	10	50	30
Future Volume (Veh/h)	20	370	45	15	305	10	40	30	15	10	50	30
Sign Control		Free			Free			Stop			Stop	
Grade		0%			0%			0%			0%	
Peak Hour Factor	0.92	0.92	0.92	0.92	0.92	0.92	0.92	0.92	0.92	0.92	0.92	0.92
Hourly flow rate (vph)	22	402	49	16	332	11	43	33	16	11	54	33
Pedestrians												
Lane Width (m)												
Walking Speed (m/s)												
Percent Blockage												
Right turn flare (veh)												
Median type		None			None							
Median storage veh												
Upstream signal (m)												
pX, platoon unblocked												
vC, conflicting volume	343			451			894	846	426	848	864	338
vC1, stage 1 conf vol												
vC2, stage 2 conf vol												
vCu, unblocked vol	343			451			894	846	426	848	864	338
tC, single (s)	4.1			4.1			7.1	6.5	6.2	7.1	6.5	6.2
tC, 2 stage (s)												
tF (s)	2.2			2.2			3.5	4.0	3.3	3.5	4.0	3.3
p0 queue free %	98			99			79	89	97	95	81	95
cM capacity (veh/h)	1216			1109			208	290	628	244	282	705
Direction, Lane #	EB 1	EB 2	WB 1	WB 2	NB 1	SB 1						
Volume Total	22	451	16	343	92	98						
Volume Left	22	0	16	0	43	11						
Volume Right	0	49	0	11	16	33						
cSH	1216	1700	1109	1700	266	346						
Volume to Capacity	0.02	0.27	0.01	0.20	0.35	0.28						
Queue Length 95th (m)	0.4	0.0	0.4	0.0	11.9	9.1						
Control Delay (s)	8.0	0.0	8.3	0.0	25.6	19.5						
Lane LOS	A		A		D	C						
Approach Delay (s)	0.4		0.4		25.6	19.5						
Approach LOS					D	C						
Intersection Summary												
Average Delay			4.5									
Intersection Capacity Utilization			40.2%		ICU Level of Service				A			
Analysis Period (min)			15									

















HCM Unsignalized Intersection Capacity Analysis
102: Clover Ave. & Wyandotte St.

Saturday Peak Hour
2027 Total Future Conditions

												
Movement	EBL	EBT	EBR	WBL	WBT	WBR	NBL	NBT	NBR	SBL	SBT	SBR
Lane Configurations												
Traffic Volume (veh/h)	10	335	40	5	285	20	35	75	10	20	130	15
Future Volume (Veh/h)	10	335	40	5	285	20	35	75	10	20	130	15
Sign Control		Free			Free			Stop			Stop	
Grade		0%			0%			0%			0%	
Peak Hour Factor	0.92	0.92	0.92	0.92	0.92	0.92	0.92	0.92	0.92	0.92	0.92	0.92
Hourly flow rate (vph)	11	364	43	5	310	22	38	82	11	22	141	16
Pedestrians												
Lane Width (m)												
Walking Speed (m/s)												
Percent Blockage												
Right turn flare (veh)												
Median type		None			None							
Median storage veh												
Upstream signal (m)												
pX, platoon unblocked												
vC, conflicting volume	332			407			814	750	386	769	760	321
vC1, stage 1 conf vol												
vC2, stage 2 conf vol												
vCu, unblocked vol	332			407			814	750	386	769	760	321
tC, single (s)	4.1			4.1			7.1	6.5	6.2	7.1	6.5	6.2
tC, 2 stage (s)												
tF (s)	2.2			2.2			3.5	4.0	3.3	3.5	4.0	3.3
p0 queue free %	99			100			80	76	98	91	57	98
cM capacity (veh/h)	1227			1152			192	336	662	251	331	720
Direction, Lane #	EB 1	EB 2	WB 1	WB 2	NB 1	SB 1						
Volume Total	11	407	5	332	131	179						
Volume Left	11	0	5	0	38	22						
Volume Right	0	43	0	22	11	16						
cSH	1227	1700	1152	1700	285	334						
Volume to Capacity	0.01	0.24	0.00	0.20	0.46	0.54						
Queue Length 95th (m)	0.2	0.0	0.1	0.0	18.2	24.0						
Control Delay (s)	8.0	0.0	8.1	0.0	27.9	27.5						
Lane LOS	A		A		D	D						
Approach Delay (s)	0.2		0.1		27.9	27.5						
Approach LOS					D	D						
Intersection Summary												
Average Delay			8.2									
Intersection Capacity Utilization			39.5%		ICU Level of Service				A			
Analysis Period (min)			15									

















HCM Unsignalized Intersection Capacity Analysis
 103: McHugh Park Driveway/Florence Ave. & McHugh St.

Saturday Peak Hour
 2027 Total Future Conditions

												
Movement	EBL	EBT	EBR	WBL	WBT	WBR	NBL	NBT	NBR	SBL	SBT	SBR
Lane Configurations												
Traffic Volume (veh/h)	110	350	0	5	325	30	10	0	5	45	0	160
Future Volume (Veh/h)	110	350	0	5	325	30	10	0	5	45	0	160
Sign Control		Free			Free			Stop			Stop	
Grade		0%			0%			0%			0%	
Peak Hour Factor	0.92	0.92	0.92	0.92	0.92	0.92	0.92	0.92	0.92	0.92	0.92	0.92
Hourly flow rate (vph)	120	380	0	5	353	33	11	0	5	49	0	174
Pedestrians												
Lane Width (m)												
Walking Speed (m/s)												
Percent Blockage												
Right turn flare (veh)												
Median type		None			None							
Median storage (veh)												
Upstream signal (m)												
pX, platoon unblocked												
vC, conflicting volume	386			380			980	1016	190	814	1000	193
vC1, stage 1 conf vol												
vC2, stage 2 conf vol												
vCu, unblocked vol	386			380			980	1016	190	814	1000	193
tC, single (s)	4.1			4.1			7.5	6.5	6.9	7.5	6.5	6.9
tC, 2 stage (s)												
tF (s)	2.2			2.2			3.5	4.0	3.3	3.5	4.0	3.3
p0 queue free %	90			100			93	100	99	80	100	79
cM capacity (veh/h)	1169			1175			147	211	820	246	216	816
Direction, Lane #	EB 1	EB 2	WB 1	WB 2	NB 1	SB 1						
Volume Total	310	190	182	210	16	223						
Volume Left	120	0	5	0	11	49						
Volume Right	0	0	0	33	5	174						
cSH	1169	1700	1175	1700	198	541						
Volume to Capacity	0.10	0.11	0.00	0.12	0.08	0.41						
Queue Length 95th (m)	2.7	0.0	0.1	0.0	2.1	16.0						
Control Delay (s)	3.9	0.0	0.3	0.0	24.8	16.3						
Lane LOS	A		A		C	C						
Approach Delay (s)	2.4		0.1		24.8	16.3						
Approach LOS					C	C						
Intersection Summary												
Average Delay			4.7									
Intersection Capacity Utilization			45.1%		ICU Level of Service				A			
Analysis Period (min)			15									

















HCM Unsignalized Intersection Capacity Analysis
104: Clover Ave. & Little River Blvd.

Saturday Peak Hour
2027 Total Future Conditions

												
Movement	EBL	EBT	EBR	WBL	WBT	WBR	NBL	NBT	NBR	SBL	SBT	SBR
Lane Configurations												
Traffic Volume (veh/h)	5	85	15	70	145	15	5	175	55	15	160	0
Future Volume (Veh/h)	5	85	15	70	145	15	5	175	55	15	160	0
Sign Control		Free			Free			Stop			Stop	
Grade		0%			0%			0%			0%	
Peak Hour Factor	0.92	0.92	0.92	0.92	0.92	0.92	0.92	0.92	0.92	0.92	0.92	0.92
Hourly flow rate (vph)	5	92	16	76	158	16	5	190	60	16	174	0
Pedestrians												
Lane Width (m)												
Walking Speed (m/s)												
Percent Blockage												
Right turn flare (veh)												
Median type		None			None							
Median storage veh												
Upstream signal (m)												
pX, platoon unblocked												
vC, conflicting volume	174			108			515	436	100	583	436	166
vC1, stage 1 conf vol												
vC2, stage 2 conf vol												
vCu, unblocked vol	174			108			515	436	100	583	436	166
tC, single (s)	4.1			4.1			7.1	6.5	6.2	7.1	6.5	6.2
tC, 2 stage (s)												
tF (s)	2.2			2.2			3.5	4.0	3.3	3.5	4.0	3.3
p0 queue free %	100			95			98	61	94	94	64	100
cM capacity (veh/h)	1403			1483			326	486	956	265	486	878
Direction, Lane #	EB 1	WB 1	NB 1	SB 1								
Volume Total	113	250	255	190								
Volume Left	5	76	5	16								
Volume Right	16	16	60	0								
cSH	1403	1483	543	454								
Volume to Capacity	0.00	0.05	0.47	0.42								
Queue Length 95th (m)	0.1	1.3	19.9	16.3								
Control Delay (s)	0.4	2.6	17.3	18.5								
Lane LOS	A	A	C	C								
Approach Delay (s)	0.4	2.6	17.3	18.5								
Approach LOS			C	C								
Intersection Summary												
Average Delay			10.7									
Intersection Capacity Utilization			42.0%		ICU Level of Service				A			
Analysis Period (min)			15									









HCM Unsignalized Intersection Capacity Analysis
201: Lublin Ave./Phase 7 Drive & Wyandotte St.

Saturday Peak Hour
2027 Total Future Conditions

												
Movement	EBL	EBT	EBR	WBL	WBT	WBR	NBL	NBT	NBR	SBL	SBT	SBR
Lane Configurations												
Traffic Volume (veh/h)	45	295	10	5	255	10	10	15	5	5	15	25
Future Volume (Veh/h)	45	295	10	5	255	10	10	15	5	5	15	25
Sign Control		Free			Free			Stop			Stop	
Grade		0%			0%			0%			0%	
Peak Hour Factor	0.92	0.92	0.92	0.92	0.92	0.92	0.92	0.92	0.92	0.92	0.92	0.92
Hourly flow rate (vph)	49	321	11	5	277	11	11	16	5	5	16	27
Pedestrians												
Lane Width (m)												
Walking Speed (m/s)												
Percent Blockage												
Right turn flare (veh)												
Median type		None			None							
Median storage veh												
Upstream signal (m)												
pX, platoon unblocked												
vC, conflicting volume	288			332			752	722	326	730	722	282
vC1, stage 1 conf vol												
vC2, stage 2 conf vol												
vCu, unblocked vol	288			332			752	722	326	730	722	282
tC, single (s)	4.1			4.1			7.1	6.5	6.2	7.1	6.5	6.2
tC, 2 stage (s)												
tF (s)	2.2			2.2			3.5	4.0	3.3	3.5	4.0	3.3
p0 queue free %	96			100			96	95	99	98	95	96
cM capacity (veh/h)	1274			1227			294	338	715	313	338	756
Direction, Lane #	EB 1	WB 1	NB 1	SB 1								
Volume Total	381	293	32	48								
Volume Left	49	5	11	5								
Volume Right	11	11	5	27								
cSH	1274	1227	349	485								
Volume to Capacity	0.04	0.00	0.09	0.10								
Queue Length 95th (m)	1.0	0.1	2.4	2.6								
Control Delay (s)	1.4	0.2	16.4	13.2								
Lane LOS	A	A	C	B								
Approach Delay (s)	1.4	0.2	16.4	13.2								
Approach LOS			C	B								
Intersection Summary												
Average Delay			2.3									
Intersection Capacity Utilization			46.6%		ICU Level of Service				A			
Analysis Period (min)			15									

















HCM Unsignalized Intersection Capacity Analysis
202: Icewater Ave. & Wyandotte St.

Saturday Peak Hour
2027 Total Future Conditions

						
Movement	EBT	EBR	WBL	WBT	NBL	NBR
Lane Configurations						
Traffic Volume (veh/h)	295	15	5	260	10	5
Future Volume (Veh/h)	295	15	5	260	10	5
Sign Control	Free			Free	Stop	
Grade	0%			0%	0%	
Peak Hour Factor	0.92	0.92	0.92	0.92	0.92	0.92
Hourly flow rate (vph)	321	16	5	283	11	5
Pedestrians						
Lane Width (m)						
Walking Speed (m/s)						
Percent Blockage						
Right turn flare (veh)						
Median type	None		None			
Median storage (veh)						
Upstream signal (m)						
pX, platoon unblocked						
vC, conflicting volume			337		622	329
vC1, stage 1 conf vol						
vC2, stage 2 conf vol						
vCu, unblocked vol			337		622	329
tC, single (s)			4.1		6.4	6.2
tC, 2 stage (s)						
tF (s)			2.2		3.5	3.3
p0 queue free %			100		98	99
cM capacity (veh/h)			1222		449	712
Direction, Lane #	EB 1	WB 1	NB 1			
Volume Total	337	288	16			
Volume Left	0	5	11			
Volume Right	16	0	5			
cSH	1700	1222	507			
Volume to Capacity	0.20	0.00	0.03			
Queue Length 95th (m)	0.0	0.1	0.8			
Control Delay (s)	0.0	0.2	12.3			
Lane LOS			A	B		
Approach Delay (s)	0.0	0.2	12.3			
Approach LOS			B			
Intersection Summary						
Average Delay			0.4			
Intersection Capacity Utilization			27.7%	ICU Level of Service		A
Analysis Period (min)			15			

HCM Unsignalized Intersection Capacity Analysis
301: Clover Ave. & Thunderbay Ave./Copernicus St.

Saturday Peak Hour
2027 Total Future Conditions

												
Movement	EBL	EBT	EBR	WBL	WBT	WBR	NBL	NBT	NBR	SBL	SBT	SBR
Lane Configurations												
Traffic Volume (veh/h)	5	0	5	0	0	10	5	95	50	10	140	5
Future Volume (Veh/h)	5	0	5	0	0	10	5	95	50	10	140	5
Sign Control		Stop			Stop			Free			Free	
Grade		0%			0%			0%			0%	
Peak Hour Factor	0.92	0.92	0.92	0.92	0.92	0.92	0.92	0.92	0.92	0.92	0.92	0.92
Hourly flow rate (vph)	5	0	5	0	0	11	5	103	54	11	152	5
Pedestrians												
Lane Width (m)												
Walking Speed (m/s)												
Percent Blockage												
Right turn flare (veh)												
Median type												
Median storage veh												
Upstream signal (m)												
pX, platoon unblocked												
vC, conflicting volume	328	344	154	322	319	130	157				157	
vC1, stage 1 conf vol												
vC2, stage 2 conf vol												
vCu, unblocked vol	328	344	154	322	319	130	157				157	
tC, single (s)	7.1	6.5	6.2	7.1	6.5	6.2	4.1				4.1	
tC, 2 stage (s)												
tF (s)	3.5	4.0	3.3	3.5	4.0	3.3	2.2				2.2	
p0 queue free %	99	100	99	100	100	99	100				99	
cM capacity (veh/h)	613	573	891	622	591	920	1423				1423	
Direction, Lane #	EB 1	WB 1	NB 1	SB 1								
Volume Total	10	11	162	168								
Volume Left	5	0	5	11								
Volume Right	5	11	54	5								
cSH	726	920	1423	1423								
Volume to Capacity	0.01	0.01	0.00	0.01								
Queue Length 95th (m)	0.3	0.3	0.1	0.2								
Control Delay (s)	10.0	9.0	0.3	0.6								
Lane LOS	B	A	A	A								
Approach Delay (s)	10.0	9.0	0.3	0.6								
Approach LOS	B	A										
Intersection Summary												
Average Delay			1.0									
Intersection Capacity Utilization			23.7%		ICU Level of Service				A			
Analysis Period (min)			15									

HCM Unsignalized Intersection Capacity Analysis
 302: Florence Ave. & Beverly Glen St.



















Saturday Peak Hour
 2027 Total Future Conditions



Movement	WBL	WBR	NBT	NBR	SBL	SBT
Lane Configurations						
Traffic Volume (veh/h)	115	0	35	105	0	55
Future Volume (Veh/h)	115	0	35	105	0	55
Sign Control	Stop		Free		Free	
Grade	0%		0%		0%	
Peak Hour Factor	0.92	0.92	0.92	0.92	0.92	0.92
Hourly flow rate (vph)	125	0	38	114	0	60
Pedestrians						
Lane Width (m)						
Walking Speed (m/s)						
Percent Blockage						
Right turn flare (veh)						
Median type			None		None	
Median storage (veh)						
Upstream signal (m)						
pX, platoon unblocked						
vC, conflicting volume	155	95			152	
vC1, stage 1 conf vol						
vC2, stage 2 conf vol						
vCu, unblocked vol	155	95			152	
tC, single (s)	6.4	6.2			4.1	
tC, 2 stage (s)						
tF (s)	3.5	3.3			2.2	
p0 queue free %	85	100			100	
cM capacity (veh/h)	836	962			1429	
Direction, Lane #	WB 1	NB 1	SB 1			
Volume Total	125	152	60			
Volume Left	125	0	0			
Volume Right	0	114	0			
cSH	836	1700	1429			
Volume to Capacity	0.15	0.09	0.00			
Queue Length 95th (m)	4.2	0.0	0.0			
Control Delay (s)	10.1	0.0	0.0			
Lane LOS	B					
Approach Delay (s)	10.1	0.0	0.0			
Approach LOS	B					
Intersection Summary						
Average Delay			3.7			
Intersection Capacity Utilization			21.3%	ICU Level of Service		A
Analysis Period (min)			15			



















HCM Unsignalized Intersection Capacity Analysis
101: Florence Ave. & Wyandotte St.

AM Peak Hour
2032 Total Future Conditions

												
Movement	EBL	EBT	EBR	WBL	WBT	WBR	NBL	NBT	NBR	SBL	SBT	SBR
Lane Configurations												
Traffic Volume (veh/h)	15	370	20	5	475	0	45	45	15	10	25	25
Future Volume (Veh/h)	15	370	20	5	475	0	45	45	15	10	25	25
Sign Control		Free			Free			Stop			Stop	
Grade		0%			0%			0%			0%	
Peak Hour Factor	0.92	0.92	0.92	0.92	0.92	0.92	0.92	0.92	0.92	0.92	0.92	0.92
Hourly flow rate (vph)	16	402	22	5	516	0	49	49	16	11	27	27
Pedestrians												
Lane Width (m)												
Walking Speed (m/s)												
Percent Blockage												
Right turn flare (veh)												
Median type		None			None							
Median storage veh												
Upstream signal (m)												
pX, platoon unblocked												
vC, conflicting volume	516			424			1012	971	413	1000	982	516
vC1, stage 1 conf vol												
vC2, stage 2 conf vol												
vCu, unblocked vol	516			424			1012	971	413	1000	982	516
tC, single (s)	4.1			4.1			7.1	6.5	6.2	7.1	6.5	6.2
tC, 2 stage (s)												
tF (s)	2.2			2.2			3.5	4.0	3.3	3.5	4.0	3.3
p0 queue free %	98			100			74	80	97	94	89	95
cM capacity (veh/h)	1050			1135			187	248	639	181	244	559
Direction, Lane #	EB 1	EB 2	WB 1	WB 2	NB 1	SB 1						
Volume Total	16	424	5	516	114	65						
Volume Left	16	0	5	0	49	11						
Volume Right	0	22	0	0	16	27						
cSH	1050	1700	1135	1700	235	296						
Volume to Capacity	0.02	0.25	0.00	0.30	0.48	0.22						
Queue Length 95th (m)	0.4	0.0	0.1	0.0	19.5	6.6						
Control Delay (s)	8.5	0.0	8.2	0.0	33.9	20.6						
Lane LOS	A		A		D	C						
Approach Delay (s)	0.3		0.1		33.9	20.6						
Approach LOS					D	C						
Intersection Summary												
Average Delay			4.7									
Intersection Capacity Utilization			44.1%		ICU Level of Service				A			
Analysis Period (min)			15									

















HCM Unsignalized Intersection Capacity Analysis
102: Clover Ave. & Wyandotte St.

AM Peak Hour
2032 Total Future Conditions

												
Movement	EBL	EBT	EBR	WBL	WBT	WBR	NBL	NBT	NBR	SBL	SBT	SBR
Lane Configurations												
Traffic Volume (veh/h)	10	370	15	0	420	30	40	120	10	15	65	5
Future Volume (Veh/h)	10	370	15	0	420	30	40	120	10	15	65	5
Sign Control		Free			Free			Stop			Stop	
Grade		0%			0%			0%			0%	
Peak Hour Factor	0.92	0.92	0.92	0.92	0.92	0.92	0.92	0.92	0.92	0.92	0.92	0.92
Hourly flow rate (vph)	11	402	16	0	457	33	43	130	11	16	71	5
Pedestrians												
Lane Width (m)												
Walking Speed (m/s)												
Percent Blockage												
Right turn flare (veh)												
Median type		None			None							
Median storage (veh)												
Upstream signal (m)												
pX, platoon unblocked												
vC, conflicting volume	490			418			930	922	410	974	914	474
vC1, stage 1 conf vol												
vC2, stage 2 conf vol												
vCu, unblocked vol	490			418			930	922	410	974	914	474
tC, single (s)	4.1			4.1			7.1	6.5	6.2	7.1	6.5	6.2
tC, 2 stage (s)												
tF (s)	2.2			2.2			3.5	4.0	3.3	3.5	4.0	3.3
p0 queue free %	99			100			78	51	98	89	74	99
cM capacity (veh/h)	1073			1141			194	267	642	139	270	591
Direction, Lane #	EB 1	EB 2	WB 1	WB 2	NB 1	SB 1						
Volume Total	11	418	0	490	184	92						
Volume Left	11	0	0	0	43	16						
Volume Right	0	16	0	33	11	5						
cSH	1073	1700	1700	1700	254	238						
Volume to Capacity	0.01	0.25	0.00	0.29	0.72	0.39						
Queue Length 95th (m)	0.2	0.0	0.0	0.0	40.1	13.8						
Control Delay (s)	8.4	0.0	0.0	0.0	49.2	29.3						
Lane LOS	A				E	D						
Approach Delay (s)	0.2		0.0		49.2	29.3						
Approach LOS					E	D						
Intersection Summary												
Average Delay			9.9									
Intersection Capacity Utilization			44.2%		ICU Level of Service				A			
Analysis Period (min)			15									

















HCM Unsignalized Intersection Capacity Analysis
 103: McHugh Park Driveway/Florence Ave. & McHugh St.

AM Peak Hour
 2032 Total Future Conditions

												
Movement	EBL	EBT	EBR	WBL	WBT	WBR	NBL	NBT	NBR	SBL	SBT	SBR
Lane Configurations												
Traffic Volume (veh/h)	50	405	10	5	505	40	0	0	5	20	0	185
Future Volume (Veh/h)	50	405	10	5	505	40	0	0	5	20	0	185
Sign Control		Free			Free			Stop			Stop	
Grade		0%			0%			0%			0%	
Peak Hour Factor	0.92	0.92	0.92	0.92	0.92	0.92	0.92	0.92	0.92	0.92	0.92	0.92
Hourly flow rate (vph)	54	440	11	5	549	43	0	0	5	22	0	201
Pedestrians												
Lane Width (m)												
Walking Speed (m/s)												
Percent Blockage												
Right turn flare (veh)												
Median type		None			None							
Median storage (veh)												
Upstream signal (m)												
pX, platoon unblocked												
vC, conflicting volume	592			451			1039	1156	226	914	1140	296
vC1, stage 1 conf vol												
vC2, stage 2 conf vol												
vCu, unblocked vol	592			451			1039	1156	226	914	1140	296
tC, single (s)	4.1			4.1			7.5	6.5	6.9	7.5	6.5	6.9
tC, 2 stage (s)												
tF (s)	2.2			2.2			3.5	4.0	3.3	3.5	4.0	3.3
p0 queue free %	94			100			100	100	99	90	100	71
cM capacity (veh/h)	980			1106			126	184	778	217	188	700
Direction, Lane #	EB 1	EB 2	WB 1	WB 2	NB 1	SB 1						
Volume Total	274	231	280	318	5	223						
Volume Left	54	0	5	0	0	22						
Volume Right	0	11	0	43	5	201						
cSH	980	1700	1106	1700	778	574						
Volume to Capacity	0.06	0.14	0.00	0.19	0.01	0.39						
Queue Length 95th (m)	1.4	0.0	0.1	0.0	0.2	14.6						
Control Delay (s)	2.2	0.0	0.2	0.0	9.7	15.2						
Lane LOS	A		A		A	C						
Approach Delay (s)	1.2		0.1		9.7	15.2						
Approach LOS					A	C						
Intersection Summary												
Average Delay			3.1									
Intersection Capacity Utilization			57.5%		ICU Level of Service				B			
Analysis Period (min)			15									

















HCM Unsignalized Intersection Capacity Analysis
104: Clover Ave. & Little River Blvd.

AM Peak Hour
2032 Total Future Conditions

												
Movement	EBL	EBT	EBR	WBL	WBT	WBR	NBL	NBT	NBR	SBL	SBT	SBR
Lane Configurations												
Traffic Volume (veh/h)	0	65	30	150	125	10	10	155	65	15	100	5
Future Volume (Veh/h)	0	65	30	150	125	10	10	155	65	15	100	5
Sign Control		Free			Free			Stop			Stop	
Grade		0%			0%			0%			0%	
Peak Hour Factor	0.92	0.92	0.92	0.92	0.92	0.92	0.92	0.92	0.92	0.92	0.92	0.92
Hourly flow rate (vph)	0	71	33	163	136	11	11	168	71	16	109	5
Pedestrians												
Lane Width (m)												
Walking Speed (m/s)												
Percent Blockage												
Right turn flare (veh)												
Median type		None			None							
Median storage veh												
Upstream signal (m)												
pX, platoon unblocked												
vC, conflicting volume	147			104			614	560	88	710	572	142
vC1, stage 1 conf vol												
vC2, stage 2 conf vol												
vCu, unblocked vol	147			104			614	560	88	710	572	142
tC, single (s)	4.1			4.1			7.1	6.5	6.2	7.1	6.5	6.2
tC, 2 stage (s)												
tF (s)	2.2			2.2			3.5	4.0	3.3	3.5	4.0	3.3
p0 queue free %	100			89			96	57	93	92	72	99
cM capacity (veh/h)	1435			1488			288	389	971	197	383	906
Direction, Lane #	EB 1	WB 1	NB 1	SB 1								
Volume Total	104	310	250	130								
Volume Left	0	163	11	16								
Volume Right	33	11	71	5								
cSH	1435	1488	460	350								
Volume to Capacity	0.00	0.11	0.54	0.37								
Queue Length 95th (m)	0.0	2.9	25.5	13.3								
Control Delay (s)	0.0	4.5	21.7	21.2								
Lane LOS		A	C	C								
Approach Delay (s)	0.0	4.5	21.7	21.2								
Approach LOS			C	C								
Intersection Summary												
Average Delay			12.1									
Intersection Capacity Utilization			42.8%		ICU Level of Service				A			
Analysis Period (min)			15									









HCM Unsignalized Intersection Capacity Analysis
201: Lublin Ave./Phase 7 Drive & Wyandotte St.

AM Peak Hour
2032 Total Future Conditions

												
Movement	EBL	EBT	EBR	WBL	WBT	WBR	NBL	NBT	NBR	SBL	SBT	SBR
Lane Configurations												
Traffic Volume (veh/h)	20	370	5	0	365	5	20	5	5	10	15	30
Future Volume (Veh/h)	20	370	5	0	365	5	20	5	5	10	15	30
Sign Control		Free			Free			Stop			Stop	
Grade		0%			0%			0%			0%	
Peak Hour Factor	0.92	0.92	0.92	0.92	0.92	0.92	0.92	0.92	0.92	0.92	0.92	0.92
Hourly flow rate (vph)	22	402	5	0	397	5	22	5	5	11	16	33
Pedestrians												
Lane Width (m)												
Walking Speed (m/s)												
Percent Blockage												
Right turn flare (veh)												
Median type		None			None							
Median storage veh												
Upstream signal (m)												
pX, platoon unblocked												
vC, conflicting volume	402			407			889	850	404	856	850	400
vC1, stage 1 conf vol												
vC2, stage 2 conf vol												
vCu, unblocked vol	402			407			889	850	404	856	850	400
tC, single (s)	4.1			4.1			7.1	6.5	6.2	7.1	6.5	6.2
tC, 2 stage (s)												
tF (s)	2.2			2.2			3.5	4.0	3.3	3.5	4.0	3.3
p0 queue free %	98			100			91	98	99	96	95	95
cM capacity (veh/h)	1157			1152			237	292	646	268	292	650
Direction, Lane #	EB 1	WB 1	NB 1	SB 1								
Volume Total	429	402	32	60								
Volume Left	22	0	22	11								
Volume Right	5	5	5	33								
cSH	1157	1152	271	409								
Volume to Capacity	0.02	0.00	0.12	0.15								
Queue Length 95th (m)	0.5	0.0	3.2	4.1								
Control Delay (s)	0.6	0.0	20.0	15.3								
Lane LOS	A		C	C								
Approach Delay (s)	0.6	0.0	20.0	15.3								
Approach LOS			C	C								
Intersection Summary												
Average Delay			2.0									
Intersection Capacity Utilization			47.6%		ICU Level of Service				A			
Analysis Period (min)			15									

















HCM Unsignalized Intersection Capacity Analysis
202: Icewater Ave. & Wyandotte St.

AM Peak Hour
2032 Total Future Conditions

						
Movement	EBT	EBR	WBL	WBT	NBL	NBR
Lane Configurations						
Traffic Volume (veh/h)	380	5	0	360	15	5
Future Volume (Veh/h)	380	5	0	360	15	5
Sign Control	Free			Free	Stop	
Grade	0%			0%	0%	
Peak Hour Factor	0.92	0.92	0.92	0.92	0.92	0.92
Hourly flow rate (vph)	413	5	0	391	16	5
Pedestrians						
Lane Width (m)						
Walking Speed (m/s)						
Percent Blockage						
Right turn flare (veh)						
Median type	None		None			
Median storage (veh)						
Upstream signal (m)						
pX, platoon unblocked						
vC, conflicting volume			418		806	416
vC1, stage 1 conf vol						
vC2, stage 2 conf vol						
vCu, unblocked vol			418		806	416
tC, single (s)			4.1		6.4	6.2
tC, 2 stage (s)						
tF (s)			2.2		3.5	3.3
p0 queue free %			100		95	99
cM capacity (veh/h)			1141		351	637
Direction, Lane #	EB 1	WB 1	NB 1			
Volume Total	418	391	21			
Volume Left	0	0	16			
Volume Right	5	0	5			
cSH	1700	1141	393			
Volume to Capacity	0.25	0.00	0.05			
Queue Length 95th (m)	0.0	0.0	1.3			
Control Delay (s)	0.0	0.0	14.7			
Lane LOS			B			
Approach Delay (s)	0.0	0.0	14.7			
Approach LOS			B			
Intersection Summary						
Average Delay			0.4			
Intersection Capacity Utilization			30.3%	ICU Level of Service		A
Analysis Period (min)			15			

HCM Unsignalized Intersection Capacity Analysis
301: Clover Ave. & Thunderbay Ave./Copernicus St.

AM Peak Hour
2032 Total Future Conditions

												
Movement	EBL	EBT	EBR	WBL	WBT	WBR	NBL	NBT	NBR	SBL	SBT	SBR
Lane Configurations												
Traffic Volume (veh/h)	5	0	5	0	0	10	5	120	20	5	80	0
Future Volume (Veh/h)	5	0	5	0	0	10	5	120	20	5	80	0
Sign Control		Stop			Stop			Free			Free	
Grade		0%			0%			0%			0%	
Peak Hour Factor	0.92	0.92	0.92	0.92	0.92	0.92	0.92	0.92	0.92	0.92	0.92	0.92
Hourly flow rate (vph)	5	0	5	0	0	11	5	130	22	5	87	0
Pedestrians												
Lane Width (m)												
Walking Speed (m/s)												
Percent Blockage												
Right turn flare (veh)												
Median type								None			None	
Median storage veh												
Upstream signal (m)												
pX, platoon unblocked												
vC, conflicting volume	259	259	87	253	248	141	87			152		
vC1, stage 1 conf vol												
vC2, stage 2 conf vol												
vCu, unblocked vol	259	259	87	253	248	141	87			152		
tC, single (s)	7.1	6.5	6.2	7.1	6.5	6.2	4.1			4.1		
tC, 2 stage (s)												
tF (s)	3.5	4.0	3.3	3.5	4.0	3.3	2.2			2.2		
p0 queue free %	99	100	99	100	100	99	100			100		
cM capacity (veh/h)	682	641	971	693	650	907	1509			1429		
Direction, Lane #	EB 1	WB 1	NB 1	SB 1								
Volume Total	10	11	157	92								
Volume Left	5	0	5	5								
Volume Right	5	11	22	0								
cSH	801	907	1509	1429								
Volume to Capacity	0.01	0.01	0.00	0.00								
Queue Length 95th (m)	0.3	0.3	0.1	0.1								
Control Delay (s)	9.5	9.0	0.3	0.4								
Lane LOS	A	A	A	A								
Approach Delay (s)	9.5	9.0	0.3	0.4								
Approach LOS	A	A										
Intersection Summary												
Average Delay			1.0									
Intersection Capacity Utilization			20.8%		ICU Level of Service				A			
Analysis Period (min)			15									

HCM Unsignalized Intersection Capacity Analysis
 302: Florence Ave. & Beverly Glen St.



















AM Peak Hour
 2032 Total Future Conditions



Movement	WBL	WBR	NBT	NBR	SBL	SBT
Lane Configurations						
Traffic Volume (veh/h)	125	0	45	50	0	40
Future Volume (Veh/h)	125	0	45	50	0	40
Sign Control	Stop		Free		Free	
Grade	0%		0%		0%	
Peak Hour Factor	0.92	0.92	0.92	0.92	0.92	0.92
Hourly flow rate (vph)	136	0	49	54	0	43
Pedestrians						
Lane Width (m)						
Walking Speed (m/s)						
Percent Blockage						
Right turn flare (veh)						
Median type	None			None		
Median storage (veh)						
Upstream signal (m)						
pX, platoon unblocked						
vC, conflicting volume	119	76			103	
vC1, stage 1 conf vol						
vC2, stage 2 conf vol						
vCu, unblocked vol	119	76			103	
tC, single (s)	6.4	6.2			4.1	
tC, 2 stage (s)						
tF (s)	3.5	3.3			2.2	
p0 queue free %	84	100			100	
cM capacity (veh/h)	877	985			1489	
Direction, Lane #	WB 1	NB 1	SB 1			
Volume Total	136	103	43			
Volume Left	136	0	0			
Volume Right	0	54	0			
cSH	877	1700	1489			
Volume to Capacity	0.16	0.06	0.00			
Queue Length 95th (m)	4.4	0.0	0.0			
Control Delay (s)	9.9	0.0	0.0			
Lane LOS	A					
Approach Delay (s)	9.9	0.0	0.0			
Approach LOS	A					
Intersection Summary						
Average Delay			4.8			
Intersection Capacity Utilization			19.0%	ICU Level of Service	A	
Analysis Period (min)			15			



















HCM Unsignalized Intersection Capacity Analysis
101: Florence Ave. & Wyandotte St.

PM Peak Hour
2032 Total Future Conditions

												
Movement	EBL	EBT	EBR	WBL	WBT	WBR	NBL	NBT	NBR	SBL	SBT	SBR
Lane Configurations												
Traffic Volume (veh/h)	30	545	45	15	345	20	35	30	10	15	60	20
Future Volume (Veh/h)	30	545	45	15	345	20	35	30	10	15	60	20
Sign Control		Free			Free			Stop			Stop	
Grade		0%			0%			0%			0%	
Peak Hour Factor	0.92	0.92	0.92	0.92	0.92	0.92	0.92	0.92	0.92	0.92	0.92	0.92
Hourly flow rate (vph)	33	592	49	16	375	22	38	33	11	16	65	22
Pedestrians												
Lane Width (m)												
Walking Speed (m/s)												
Percent Blockage												
Right turn flare (veh)												
Median type		None			None							
Median storage (veh)												
Upstream signal (m)												
pX, platoon unblocked												
vC, conflicting volume	397			641			1144	1112	616	1104	1125	386
vC1, stage 1 conf vol												
vC2, stage 2 conf vol												
vCu, unblocked vol	397			641			1144	1112	616	1104	1125	386
tC, single (s)	4.1			4.1			7.1	6.5	6.2	7.1	6.5	6.2
tC, 2 stage (s)												
tF (s)	2.2			2.2			3.5	4.0	3.3	3.5	4.0	3.3
p0 queue free %	97			98			69	83	98	90	67	97
cM capacity (veh/h)	1162			943			123	200	490	156	196	662
Direction, Lane #	EB 1	EB 2	WB 1	WB 2	NB 1	SB 1						
Volume Total	33	641	16	397	82	103						
Volume Left	33	0	16	0	38	16						
Volume Right	0	49	0	22	11	22						
cSH	1162	1700	943	1700	165	220						
Volume to Capacity	0.03	0.38	0.02	0.23	0.50	0.47						
Queue Length 95th (m)	0.7	0.0	0.4	0.0	19.2	18.3						
Control Delay (s)	8.2	0.0	8.9	0.0	46.6	35.0						
Lane LOS	A		A		E	D						
Approach Delay (s)	0.4		0.3		46.6	35.0						
Approach LOS					E	D						
Intersection Summary												
Average Delay			6.2									
Intersection Capacity Utilization			47.8%		ICU Level of Service				A			
Analysis Period (min)			15									

















HCM Unsignalized Intersection Capacity Analysis
102: Clover Ave. & Wyandotte St.

PM Peak Hour
2032 Total Future Conditions

												
Movement	EBL	EBT	EBR	WBL	WBT	WBR	NBL	NBT	NBR	SBL	SBT	SBR
Lane Configurations												
Traffic Volume (veh/h)	10	505	40	5	335	20	30	90	10	25	155	10
Future Volume (Veh/h)	10	505	40	5	335	20	30	90	10	25	155	10
Sign Control		Free			Free			Stop			Stop	
Grade		0%			0%			0%			0%	
Peak Hour Factor	0.92	0.92	0.92	0.92	0.92	0.92	0.92	0.92	0.92	0.92	0.92	0.92
Hourly flow rate (vph)	11	549	43	5	364	22	33	98	11	27	168	11
Pedestrians												
Lane Width (m)												
Walking Speed (m/s)												
Percent Blockage												
Right turn flare (veh)												
Median type		None			None							
Median storage veh												
Upstream signal (m)												
pX, platoon unblocked												
vC, conflicting volume	386			592			1062	988	570	1016	999	375
vC1, stage 1 conf vol												
vC2, stage 2 conf vol												
vCu, unblocked vol	386			592			1062	988	570	1016	999	375
tC, single (s)	4.1			4.1			7.1	6.5	6.2	7.1	6.5	6.2
tC, 2 stage (s)												
tF (s)	2.2			2.2			3.5	4.0	3.3	3.5	4.0	3.3
p0 queue free %	99			99			61	60	98	81	30	98
cM capacity (veh/h)	1172			984			85	243	521	144	240	671
Direction, Lane #	EB 1	EB 2	WB 1	WB 2	NB 1	SB 1						
Volume Total	11	592	5	386	142	206						
Volume Left	11	0	5	0	33	27						
Volume Right	0	43	0	22	11	11						
cSH	1172	1700	984	1700	175	228						
Volume to Capacity	0.01	0.35	0.01	0.23	0.81	0.90						
Queue Length 95th (m)	0.2	0.0	0.1	0.0	44.2	60.3						
Control Delay (s)	8.1	0.0	8.7	0.0	79.9	82.3						
Lane LOS	A		A		F	F						
Approach Delay (s)	0.1		0.1		79.9	82.3						
Approach LOS					F	F						
Intersection Summary												
Average Delay			21.2									
Intersection Capacity Utilization			47.5%		ICU Level of Service				A			
Analysis Period (min)			15									

















HCM Unsignalized Intersection Capacity Analysis
 103: McHugh Park Driveway/Florence Ave. & McHugh St.

PM Peak Hour
 2032 Total Future Conditions

												
Movement	EBL	EBT	EBR	WBL	WBT	WBR	NBL	NBT	NBR	SBL	SBT	SBR
Lane Configurations												
Traffic Volume (veh/h)	150	490	10	5	475	30	10	0	0	55	0	150
Future Volume (Veh/h)	150	490	10	5	475	30	10	0	0	55	0	150
Sign Control		Free			Free			Stop			Stop	
Grade		0%			0%			0%			0%	
Peak Hour Factor	0.92	0.92	0.92	0.92	0.92	0.92	0.92	0.92	0.92	0.92	0.92	0.92
Hourly flow rate (vph)	163	533	11	5	516	33	11	0	0	60	0	163
Pedestrians												
Lane Width (m)												
Walking Speed (m/s)												
Percent Blockage												
Right turn flare (veh)												
Median type		None			None							
Median storage veh												
Upstream signal (m)												
pX, platoon unblocked												
vC, conflicting volume	549			544			1296	1424	272	1135	1412	274
vC1, stage 1 conf vol												
vC2, stage 2 conf vol												
vCu, unblocked vol	549			544			1296	1424	272	1135	1412	274
tC, single (s)	4.1			4.1			7.5	6.5	6.9	7.5	6.5	6.9
tC, 2 stage (s)												
tF (s)	2.2			2.2			3.5	4.0	3.3	3.5	4.0	3.3
p0 queue free %	84			100			86	100	100	56	100	77
cM capacity (veh/h)	1017			1021			81	113	726	137	114	723
Direction, Lane #	EB 1	EB 2	WB 1	WB 2	NB 1	SB 1						
Volume Total	430	278	263	291	11	223						
Volume Left	163	0	5	0	11	60						
Volume Right	0	11	0	33	0	163						
cSH	1017	1700	1021	1700	81	337						
Volume to Capacity	0.16	0.16	0.00	0.17	0.14	0.66						
Queue Length 95th (m)	4.6	0.0	0.1	0.0	3.6	35.8						
Control Delay (s)	4.6	0.0	0.2	0.0	56.3	34.4						
Lane LOS	A		A		F	D						
Approach Delay (s)	2.8		0.1		56.3	34.4						
Approach LOS					F	D						
Intersection Summary												
Average Delay			6.9									
Intersection Capacity Utilization			53.6%		ICU Level of Service				A			
Analysis Period (min)			15									

















HCM Unsignalized Intersection Capacity Analysis
104: Clover Ave. & Little River Blvd.

PM Peak Hour
2032 Total Future Conditions

												
Movement	EBL	EBT	EBR	WBL	WBT	WBR	NBL	NBT	NBR	SBL	SBT	SBR
Lane Configurations												
Traffic Volume (veh/h)	0	95	10	95	120	10	30	190	110	20	170	5
Future Volume (Veh/h)	0	95	10	95	120	10	30	190	110	20	170	5
Sign Control		Free			Free			Stop			Stop	
Grade		0%			0%			0%			0%	
Peak Hour Factor	0.92	0.92	0.92	0.92	0.92	0.92	0.92	0.92	0.92	0.92	0.92	0.92
Hourly flow rate (vph)	0	103	11	103	130	11	33	207	120	22	185	5
Pedestrians												
Lane Width (m)												
Walking Speed (m/s)												
Percent Blockage												
Right turn flare (veh)												
Median type		None			None							
Median storage veh												
Upstream signal (m)												
pX, platoon unblocked												
vC, conflicting volume	141			114			548	456	108	674	456	136
vC1, stage 1 conf vol												
vC2, stage 2 conf vol												
vCu, unblocked vol	141			114			548	456	108	674	456	136
tC, single (s)	4.1			4.1			7.1	6.5	6.2	7.1	6.5	6.2
tC, 2 stage (s)												
tF (s)	2.2			2.2			3.5	4.0	3.3	3.5	4.0	3.3
p0 queue free %	100			93			89	56	87	89	60	99
cM capacity (veh/h)	1442			1475			292	466	945	200	466	913
Direction, Lane #	EB 1	WB 1	NB 1	SB 1								
Volume Total	114	244	360	212								
Volume Left	0	103	33	22								
Volume Right	11	11	120	5								
cSH	1442	1475	526	413								
Volume to Capacity	0.00	0.07	0.68	0.51								
Queue Length 95th (m)	0.0	1.8	41.6	22.7								
Control Delay (s)	0.0	3.6	25.4	22.5								
Lane LOS		A	D	C								
Approach Delay (s)	0.0	3.6	25.4	22.5								
Approach LOS			D	C								
Intersection Summary												
Average Delay			15.9									
Intersection Capacity Utilization			49.1%		ICU Level of Service				A			
Analysis Period (min)			15									

HCM Unsignalized Intersection Capacity Analysis
201: Lublin Ave./Phase 7 Drive & Wyandotte St.

PM Peak Hour
2032 Total Future Conditions

												
Movement	EBL	EBT	EBR	WBL	WBT	WBR	NBL	NBT	NBR	SBL	SBT	SBR
Lane Configurations												
Traffic Volume (veh/h)	35	460	15	5	320	10	5	15	5	5	15	25
Future Volume (Veh/h)	35	460	15	5	320	10	5	15	5	5	15	25
Sign Control		Free			Free			Stop			Stop	
Grade		0%			0%			0%			0%	
Peak Hour Factor	0.92	0.92	0.92	0.92	0.92	0.92	0.92	0.92	0.92	0.92	0.92	0.92
Hourly flow rate (vph)	38	500	16	5	348	11	5	16	5	5	16	27
Pedestrians												
Lane Width (m)												
Walking Speed (m/s)												
Percent Blockage												
Right turn flare (veh)												
Median type		None			None							
Median storage veh												
Upstream signal (m)												
pX, platoon unblocked												
vC, conflicting volume	359			516			982	953	508	960	956	354
vC1, stage 1 conf vol												
vC2, stage 2 conf vol												
vCu, unblocked vol	359			516			982	953	508	960	956	354
tC, single (s)	4.1			4.1			7.1	6.5	6.2	7.1	6.5	6.2
tC, 2 stage (s)												
tF (s)	2.2			2.2			3.5	4.0	3.3	3.5	4.0	3.3
p0 queue free %	97			100			98	94	99	98	94	96
cM capacity (veh/h)	1200			1050			203	250	565	216	249	690
Direction, Lane #	EB 1	WB 1	NB 1	SB 1								
Volume Total	554	364	26	48								
Volume Left	38	5	5	5								
Volume Right	16	11	5	27								
cSH	1200	1050	266	379								
Volume to Capacity	0.03	0.00	0.10	0.13								
Queue Length 95th (m)	0.8	0.1	2.6	3.4								
Control Delay (s)	0.9	0.2	20.0	15.9								
Lane LOS	A	A	C	C								
Approach Delay (s)	0.9	0.2	20.0	15.9								
Approach LOS			C	C								
Intersection Summary												
Average Delay			1.9									
Intersection Capacity Utilization			55.5%		ICU Level of Service				B			
Analysis Period (min)			15									

HCM Unsignalized Intersection Capacity Analysis
 202: Icewater Ave. & Wyandotte St.

















PM Peak Hour
 2032 Total Future Conditions



Movement	EBT	EBR	WBL	WBT	NBL	NBR
Lane Configurations	↔			↔	↔	
Traffic Volume (veh/h)	455	15	5	325	10	0
Future Volume (Veh/h)	455	15	5	325	10	0
Sign Control	Free			Free	Stop	
Grade	0%			0%	0%	
Peak Hour Factor	0.92	0.92	0.92	0.92	0.92	0.92
Hourly flow rate (vph)	495	16	5	353	11	0
Pedestrians						
Lane Width (m)						
Walking Speed (m/s)						
Percent Blockage						
Right turn flare (veh)						
Median type	None		None			
Median storage (veh)						
Upstream signal (m)						
pX, platoon unblocked						
vC, conflicting volume			511		866	503
vC1, stage 1 conf vol						
vC2, stage 2 conf vol						
vCu, unblocked vol			511		866	503
tC, single (s)			4.1		6.4	6.2
tC, 2 stage (s)						
tF (s)			2.2		3.5	3.3
p0 queue free %			100		97	100
cM capacity (veh/h)			1054		322	569
Direction, Lane #	EB 1	WB 1	NB 1			
Volume Total	511	358	11			
Volume Left	0	5	11			
Volume Right	16	0	0			
cSH	1700	1054	322			
Volume to Capacity	0.30	0.00	0.03			
Queue Length 95th (m)	0.0	0.1	0.8			
Control Delay (s)	0.0	0.2	16.6			
Lane LOS	A		C			
Approach Delay (s)	0.0	0.2	16.6			
Approach LOS	A		C			
Intersection Summary						
Average Delay			0.3			
Intersection Capacity Utilization			34.9%	ICU Level of Service		A
Analysis Period (min)			15			

HCM Unsignalized Intersection Capacity Analysis
301: Clover Ave. & Thunderbay Ave./Copernicus St.

PM Peak Hour
2032 Total Future Conditions

												
Movement	EBL	EBT	EBR	WBL	WBT	WBR	NBL	NBT	NBR	SBL	SBT	SBR
Lane Configurations												
Traffic Volume (veh/h)	5	0	5	5	0	5	5	110	50	15	160	5
Future Volume (Veh/h)	5	0	5	5	0	5	5	110	50	15	160	5
Sign Control		Stop			Stop			Free			Free	
Grade		0%			0%			0%			0%	
Peak Hour Factor	0.92	0.92	0.92	0.92	0.92	0.92	0.92	0.92	0.92	0.92	0.92	0.92
Hourly flow rate (vph)	5	0	5	5	0	5	5	120	54	16	174	5
Pedestrians												
Lane Width (m)												
Walking Speed (m/s)												
Percent Blockage												
Right turn flare (veh)												
Median type												
								None			None	
Median storage veh												
Upstream signal (m)												
pX, platoon unblocked												
vC, conflicting volume	370	392	176	370	368	147	179			174		
vC1, stage 1 conf vol												
vC2, stage 2 conf vol												
vCu, unblocked vol	370	392	176	370	368	147	179			174		
tC, single (s)	7.1	6.5	6.2	7.1	6.5	6.2	4.1			4.1		
tC, 2 stage (s)												
tF (s)	3.5	4.0	3.3	3.5	4.0	3.3	2.2			2.2		
p0 queue free %	99	100	99	99	100	99	100			99		
cM capacity (veh/h)	576	535	867	576	553	900	1397			1403		
Direction, Lane #												
	EB 1	WB 1	NB 1	SB 1								
Volume Total	10	10	179	195								
Volume Left	5	5	5	16								
Volume Right	5	5	54	5								
cSH	692	703	1397	1403								
Volume to Capacity	0.01	0.01	0.00	0.01								
Queue Length 95th (m)	0.4	0.3	0.1	0.3								
Control Delay (s)	10.3	10.2	0.2	0.7								
Lane LOS	B	B	A	A								
Approach Delay (s)	10.3	10.2	0.2	0.7								
Approach LOS	B	B										
Intersection Summary												
Average Delay			1.0									
Intersection Capacity Utilization			25.5%		ICU Level of Service					A		
Analysis Period (min)			15									

HCM Unsignalized Intersection Capacity Analysis
302: Florence Ave. & Beverly Glen St.



















PM Peak Hour
2032 Total Future Conditions



Movement	WBL	WBR	NBT	NBR	SBL	SBT
Lane Configurations						
Traffic Volume (veh/h)	105	0	45	140	0	65
Future Volume (Veh/h)	105	0	45	140	0	65
Sign Control	Stop		Free		Free	
Grade	0%		0%		0%	
Peak Hour Factor	0.92	0.92	0.92	0.92	0.92	0.92
Hourly flow rate (vph)	114	0	49	152	0	71
Pedestrians						
Lane Width (m)						
Walking Speed (m/s)						
Percent Blockage						
Right turn flare (veh)						
Median type	None			None		
Median storage (veh)						
Upstream signal (m)						
pX, platoon unblocked						
vC, conflicting volume	196	125			201	
vC1, stage 1 conf vol						
vC2, stage 2 conf vol						
vCu, unblocked vol	196	125			201	
tC, single (s)	6.4	6.2			4.1	
tC, 2 stage (s)						
tF (s)	3.5	3.3			2.2	
p0 queue free %	86	100			100	
cM capacity (veh/h)	793	926			1371	
Direction, Lane #	WB 1	NB 1	SB 1			
Volume Total	114	201	71			
Volume Left	114	0	0			
Volume Right	0	152	0			
cSH	793	1700	1371			
Volume to Capacity	0.14	0.12	0.00			
Queue Length 95th (m)	4.0	0.0	0.0			
Control Delay (s)	10.3	0.0	0.0			
Lane LOS	B					
Approach Delay (s)	10.3	0.0	0.0			
Approach LOS	B					
Intersection Summary						
Average Delay			3.0			
Intersection Capacity Utilization			23.5%	ICU Level of Service	A	
Analysis Period (min)			15			



















HCM Unsignalized Intersection Capacity Analysis
 101: Florence Ave. & Wyandotte St.

Saturday Peak Hour
 2032 Total Future Conditions

												
Movement	EBL	EBT	EBR	WBL	WBT	WBR	NBL	NBT	NBR	SBL	SBT	SBR
Lane Configurations												
Traffic Volume (veh/h)	20	385	45	15	315	10	40	30	15	10	50	30
Future Volume (Veh/h)	20	385	45	15	315	10	40	30	15	10	50	30
Sign Control		Free			Free			Stop			Stop	
Grade		0%			0%			0%			0%	
Peak Hour Factor	0.92	0.92	0.92	0.92	0.92	0.92	0.92	0.92	0.92	0.92	0.92	0.92
Hourly flow rate (vph)	22	418	49	16	342	11	43	33	16	11	54	33
Pedestrians												
Lane Width (m)												
Walking Speed (m/s)												
Percent Blockage												
Right turn flare (veh)												
Median type		None			None							
Median storage veh												
Upstream signal (m)												
pX, platoon unblocked												
vC, conflicting volume	353			467			920	872	442	874	890	348
vC1, stage 1 conf vol												
vC2, stage 2 conf vol												
vCu, unblocked vol	353			467			920	872	442	874	890	348
tC, single (s)	4.1			4.1			7.1	6.5	6.2	7.1	6.5	6.2
tC, 2 stage (s)												
tF (s)	2.2			2.2			3.5	4.0	3.3	3.5	4.0	3.3
p0 queue free %	98			99			78	88	97	95	80	95
cM capacity (veh/h)	1206			1094			198	280	615	234	273	696
Direction, Lane #	EB 1	EB 2	WB 1	WB 2	NB 1	SB 1						
Volume Total	22	467	16	353	92	98						
Volume Left	22	0	16	0	43	11						
Volume Right	0	49	0	11	16	33						
cSH	1206	1700	1094	1700	255	335						
Volume to Capacity	0.02	0.27	0.01	0.21	0.36	0.29						
Queue Length 95th (m)	0.4	0.0	0.4	0.0	12.6	9.5						
Control Delay (s)	8.0	0.0	8.3	0.0	26.9	20.1						
Lane LOS	A		A		D	C						
Approach Delay (s)	0.4		0.4		26.9	20.1						
Approach LOS					D	C						
Intersection Summary												
Average Delay			4.5									
Intersection Capacity Utilization			41.0%		ICU Level of Service				A			
Analysis Period (min)			15									

















HCM Unsignalized Intersection Capacity Analysis
102: Clover Ave. & Wyandotte St.

Saturday Peak Hour
2032 Total Future Conditions

												
Movement	EBL	EBT	EBR	WBL	WBT	WBR	NBL	NBT	NBR	SBL	SBT	SBR
Lane Configurations												
Traffic Volume (veh/h)	10	350	40	5	295	20	35	75	10	25	130	15
Future Volume (Veh/h)	10	350	40	5	295	20	35	75	10	25	130	15
Sign Control		Free			Free			Stop			Stop	
Grade		0%			0%			0%			0%	
Peak Hour Factor	0.92	0.92	0.92	0.92	0.92	0.92	0.92	0.92	0.92	0.92	0.92	0.92
Hourly flow rate (vph)	11	380	43	5	321	22	38	82	11	27	141	16
Pedestrians												
Lane Width (m)												
Walking Speed (m/s)												
Percent Blockage												
Right turn flare (veh)												
Median type		None			None							
Median storage veh												
Upstream signal (m)												
pX, platoon unblocked												
vC, conflicting volume	343			423			841	776	402	796	787	332
vC1, stage 1 conf vol												
vC2, stage 2 conf vol												
vCu, unblocked vol	343			423			841	776	402	796	787	332
tC, single (s)	4.1			4.1			7.1	6.5	6.2	7.1	6.5	6.2
tC, 2 stage (s)												
tF (s)	2.2			2.2			3.5	4.0	3.3	3.5	4.0	3.3
p0 queue free %	99			100			79	75	98	89	56	98
cM capacity (veh/h)	1216			1136			180	324	649	239	319	710
Direction, Lane #	EB 1	EB 2	WB 1	WB 2	NB 1	SB 1						
Volume Total	11	423	5	343	131	184						
Volume Left	11	0	5	0	38	27						
Volume Right	0	43	0	22	11	16						
cSH	1216	1700	1136	1700	272	319						
Volume to Capacity	0.01	0.25	0.00	0.20	0.48	0.58						
Queue Length 95th (m)	0.2	0.0	0.1	0.0	19.5	27.2						
Control Delay (s)	8.0	0.0	8.2	0.0	29.9	30.6						
Lane LOS	A		A		D	D						
Approach Delay (s)	0.2		0.1		29.9	30.6						
Approach LOS					D	D						
Intersection Summary												
Average Delay			8.8									
Intersection Capacity Utilization			39.2%		ICU Level of Service				A			
Analysis Period (min)			15									

















HCM Unsignalized Intersection Capacity Analysis
 103: McHugh Park Driveway/Florence Ave. & McHugh St.

Saturday Peak Hour
 2032 Total Future Conditions

												
Movement	EBL	EBT	EBR	WBL	WBT	WBR	NBL	NBT	NBR	SBL	SBT	SBR
Lane Configurations												
Traffic Volume (veh/h)	115	365	0	5	340	30	10	0	5	45	0	170
Future Volume (Veh/h)	115	365	0	5	340	30	10	0	5	45	0	170
Sign Control		Free			Free			Stop			Stop	
Grade		0%			0%			0%			0%	
Peak Hour Factor	0.92	0.92	0.92	0.92	0.92	0.92	0.92	0.92	0.92	0.92	0.92	0.92
Hourly flow rate (vph)	125	397	0	5	370	33	11	0	5	49	0	185
Pedestrians												
Lane Width (m)												
Walking Speed (m/s)												
Percent Blockage												
Right turn flare (veh)												
Median type		None			None							
Median storage (veh)												
Upstream signal (m)												
pX, platoon unblocked												
vC, conflicting volume	403			397			1027	1060	198	850	1044	202
vC1, stage 1 conf vol												
vC2, stage 2 conf vol												
vCu, unblocked vol	403			397			1027	1060	198	850	1044	202
tC, single (s)	4.1			4.1			7.5	6.5	6.9	7.5	6.5	6.9
tC, 2 stage (s)												
tF (s)	2.2			2.2			3.5	4.0	3.3	3.5	4.0	3.3
p0 queue free %	89			100			92	100	99	79	100	77
cM capacity (veh/h)	1152			1158			133	198	809	231	202	806
Direction, Lane #	EB 1	EB 2	WB 1	WB 2	NB 1	SB 1						
Volume Total	324	198	190	218	16	234						
Volume Left	125	0	5	0	11	49						
Volume Right	0	0	0	33	5	185						
cSH	1152	1700	1158	1700	180	529						
Volume to Capacity	0.11	0.12	0.00	0.13	0.09	0.44						
Queue Length 95th (m)	2.9	0.0	0.1	0.0	2.3	17.9						
Control Delay (s)	3.9	0.0	0.3	0.0	27.0	17.1						
Lane LOS	A		A		D	C						
Approach Delay (s)	2.4		0.1		27.0	17.1						
Approach LOS					D	C						
Intersection Summary												
Average Delay			4.9									
Intersection Capacity Utilization			46.7%		ICU Level of Service				A			
Analysis Period (min)			15									

















HCM Unsignalized Intersection Capacity Analysis
104: Clover Ave. & Little River Blvd.

Saturday Peak Hour
2032 Total Future Conditions

												
Movement	EBL	EBT	EBR	WBL	WBT	WBR	NBL	NBT	NBR	SBL	SBT	SBR
Lane Configurations												
Traffic Volume (veh/h)	5	90	15	75	150	15	10	175	60	15	160	0
Future Volume (Veh/h)	5	90	15	75	150	15	10	175	60	15	160	0
Sign Control		Free			Free			Stop			Stop	
Grade		0%			0%			0%			0%	
Peak Hour Factor	0.92	0.92	0.92	0.92	0.92	0.92	0.92	0.92	0.92	0.92	0.92	0.92
Hourly flow rate (vph)	5	98	16	82	163	16	11	190	65	16	174	0
Pedestrians												
Lane Width (m)												
Walking Speed (m/s)												
Percent Blockage												
Right turn flare (veh)												
Median type		None			None							
Median storage veh												
Upstream signal (m)												
pX, platoon unblocked												
vC, conflicting volume	179			114			538	459	106	611	459	171
vC1, stage 1 conf vol												
vC2, stage 2 conf vol												
vCu, unblocked vol	179			114			538	459	106	611	459	171
tC, single (s)	4.1			4.1			7.1	6.5	6.2	7.1	6.5	6.2
tC, 2 stage (s)												
tF (s)	2.2			2.2			3.5	4.0	3.3	3.5	4.0	3.3
p0 queue free %	100			94			96	60	93	94	63	100
cM capacity (veh/h)	1397			1475			310	469	948	248	469	873
Direction, Lane #	EB 1	WB 1	NB 1	SB 1								
Volume Total	119	261	266	190								
Volume Left	5	82	11	16								
Volume Right	16	16	65	0								
cSH	1397	1475	523	436								
Volume to Capacity	0.00	0.06	0.51	0.44								
Queue Length 95th (m)	0.1	1.4	22.8	17.3								
Control Delay (s)	0.3	2.7	18.8	19.5								
Lane LOS	A	A	C	C								
Approach Delay (s)	0.3	2.7	18.8	19.5								
Approach LOS			C	C								
Intersection Summary												
Average Delay			11.3									
Intersection Capacity Utilization			41.6%		ICU Level of Service				A			
Analysis Period (min)			15									









HCM Unsignalized Intersection Capacity Analysis
201: Lublin Ave./Phase 7 Drive & Wyandotte St.

Saturday Peak Hour
2032 Total Future Conditions

												
Movement	EBL	EBT	EBR	WBL	WBT	WBR	NBL	NBT	NBR	SBL	SBT	SBR
Lane Configurations												
Traffic Volume (veh/h)	45	310	10	5	270	10	10	15	5	5	15	25
Future Volume (Veh/h)	45	310	10	5	270	10	10	15	5	5	15	25
Sign Control		Free			Free			Stop			Stop	
Grade		0%			0%			0%			0%	
Peak Hour Factor	0.92	0.92	0.92	0.92	0.92	0.92	0.92	0.92	0.92	0.92	0.92	0.92
Hourly flow rate (vph)	49	337	11	5	293	11	11	16	5	5	16	27
Pedestrians												
Lane Width (m)												
Walking Speed (m/s)												
Percent Blockage												
Right turn flare (veh)												
Median type		None			None							
Median storage veh												
Upstream signal (m)												
pX, platoon unblocked												
vC, conflicting volume	304			348			784	754	342	762	754	298
vC1, stage 1 conf vol												
vC2, stage 2 conf vol												
vCu, unblocked vol	304			348			784	754	342	762	754	298
tC, single (s)	4.1			4.1			7.1	6.5	6.2	7.1	6.5	6.2
tC, 2 stage (s)												
tF (s)	2.2			2.2			3.5	4.0	3.3	3.5	4.0	3.3
p0 queue free %	96			100			96	95	99	98	95	96
cM capacity (veh/h)	1257			1211			279	323	700	297	323	741
Direction, Lane #	EB 1	WB 1	NB 1	SB 1								
Volume Total	397	309	32	48								
Volume Left	49	5	11	5								
Volume Right	11	11	5	27								
cSH	1257	1211	333	467								
Volume to Capacity	0.04	0.00	0.10	0.10								
Queue Length 95th (m)	1.0	0.1	2.5	2.7								
Control Delay (s)	1.3	0.2	17.0	13.6								
Lane LOS	A	A	C	B								
Approach Delay (s)	1.3	0.2	17.0	13.6								
Approach LOS			C	B								
Intersection Summary												
Average Delay			2.3									
Intersection Capacity Utilization			48.2%		ICU Level of Service				A			
Analysis Period (min)			15									

















HCM Unsignalized Intersection Capacity Analysis
202: Icewater Ave. & Wyandotte St.

Saturday Peak Hour
2032 Total Future Conditions

						
Movement	EBT	EBR	WBL	WBT	NBL	NBR
Lane Configurations						
Traffic Volume (veh/h)	310	15	5	270	10	5
Future Volume (Veh/h)	310	15	5	270	10	5
Sign Control	Free			Free	Stop	
Grade	0%			0%	0%	
Peak Hour Factor	0.92	0.92	0.92	0.92	0.92	0.92
Hourly flow rate (vph)	337	16	5	293	11	5
Pedestrians						
Lane Width (m)						
Walking Speed (m/s)						
Percent Blockage						
Right turn flare (veh)						
Median type	None		None			
Median storage (veh)						
Upstream signal (m)						
pX, platoon unblocked						
vC, conflicting volume			353		648	345
vC1, stage 1 conf vol						
vC2, stage 2 conf vol						
vCu, unblocked vol			353		648	345
tC, single (s)			4.1		6.4	6.2
tC, 2 stage (s)						
tF (s)			2.2		3.5	3.3
p0 queue free %			100		97	99
cM capacity (veh/h)			1206		433	698
Direction, Lane #	EB 1	WB 1	NB 1			
Volume Total	353	298	16			
Volume Left	0	5	11			
Volume Right	16	0	5			
cSH	1700	1206	491			
Volume to Capacity	0.21	0.00	0.03			
Queue Length 95th (m)	0.0	0.1	0.8			
Control Delay (s)	0.0	0.2	12.6			
Lane LOS	A		B			
Approach Delay (s)	0.0	0.2	12.6			
Approach LOS	A		B			
Intersection Summary						
Average Delay			0.4			
Intersection Capacity Utilization			28.2%	ICU Level of Service		A
Analysis Period (min)			15			









HCM Unsignalized Intersection Capacity Analysis
301: Clover Ave. & Thunderbay Ave./Copernicus St.

Saturday Peak Hour
2032 Total Future Conditions

												
Movement	EBL	EBT	EBR	WBL	WBT	WBR	NBL	NBT	NBR	SBL	SBT	SBR
Lane Configurations												
Traffic Volume (veh/h)	5	0	5	0	0	10	5	95	50	10	140	5
Future Volume (Veh/h)	5	0	5	0	0	10	5	95	50	10	140	5
Sign Control	Stop			Stop			Free			Free		
Grade	0%			0%			0%			0%		
Peak Hour Factor	0.92	0.92	0.92	0.92	0.92	0.92	0.92	0.92	0.92	0.92	0.92	0.92
Hourly flow rate (vph)	5	0	5	0	0	11	5	103	54	11	152	5
Pedestrians												
Lane Width (m)												
Walking Speed (m/s)												
Percent Blockage												
Right turn flare (veh)												
Median type						None			None			
Median storage veh												
Upstream signal (m)												
pX, platoon unblocked												
vC, conflicting volume	328	344	154	322	319	130	157			157		
vC1, stage 1 conf vol												
vC2, stage 2 conf vol												
vCu, unblocked vol	328	344	154	322	319	130	157			157		
tC, single (s)	7.1	6.5	6.2	7.1	6.5	6.2	4.1			4.1		
tC, 2 stage (s)												
tF (s)	3.5	4.0	3.3	3.5	4.0	3.3	2.2			2.2		
p0 queue free %	99	100	99	100	100	99	100			99		
cM capacity (veh/h)	613	573	891	622	591	920	1423			1423		
Direction, Lane #	EB 1	WB 1	NB 1	SB 1								
Volume Total	10	11	162	168								
Volume Left	5	0	5	11								
Volume Right	5	11	54	5								
cSH	726	920	1423	1423								
Volume to Capacity	0.01	0.01	0.00	0.01								
Queue Length 95th (m)	0.3	0.3	0.1	0.2								
Control Delay (s)	10.0	9.0	0.3	0.6								
Lane LOS	B	A	A	A								
Approach Delay (s)	10.0	9.0	0.3	0.6								
Approach LOS	B	A										
Intersection Summary												
Average Delay			1.0									
Intersection Capacity Utilization			23.7%	ICU Level of Service	A							
Analysis Period (min)			15									



















HCM Unsignalized Intersection Capacity Analysis
 302: Florence Ave. & Beverly Glen St.

Saturday Peak Hour
 2032 Total Future Conditions

						
Movement	WBL	WBR	NBT	NBR	SBL	SBT
Lane Configurations						
Traffic Volume (veh/h)	120	0	35	110	0	55
Future Volume (Veh/h)	120	0	35	110	0	55
Sign Control	Stop		Free		Free	
Grade	0%		0%		0%	
Peak Hour Factor	0.92	0.92	0.92	0.92	0.92	0.92
Hourly flow rate (vph)	130	0	38	120	0	60
Pedestrians						
Lane Width (m)						
Walking Speed (m/s)						
Percent Blockage						
Right turn flare (veh)						
Median type	None			None		
Median storage (veh)						
Upstream signal (m)						
pX, platoon unblocked						
vC, conflicting volume	158	98			158	
vC1, stage 1 conf vol						
vC2, stage 2 conf vol						
vCu, unblocked vol	158	98			158	
tC, single (s)	6.4	6.2			4.1	
tC, 2 stage (s)						
tF (s)	3.5	3.3			2.2	
p0 queue free %	84	100			100	
cM capacity (veh/h)	833	958			1422	
Direction, Lane #	WB 1	NB 1	SB 1			
Volume Total	130	158	60			
Volume Left	130	0	0			
Volume Right	0	120	0			
cSH	833	1700	1422			
Volume to Capacity	0.16	0.09	0.00			
Queue Length 95th (m)	4.4	0.0	0.0			
Control Delay (s)	10.1	0.0	0.0			
Lane LOS	B					
Approach Delay (s)	10.1	0.0	0.0			
Approach LOS	B					
Intersection Summary						
Average Delay			3.8			
Intersection Capacity Utilization			21.9%	ICU Level of Service		A
Analysis Period (min)			15			



















HCM Unsignalized Intersection Capacity Analysis
101: Florence Ave. & Wyandotte St.

AM Peak Hour
2027 Total Future Conditions

												
Movement	EBL	EBT	EBR	WBL	WBT	WBR	NBL	NBT	NBR	SBL	SBT	SBR
Lane Configurations												
Traffic Volume (veh/h)	15	355	20	5	455	0	45	10	15	10	5	25
Future Volume (Veh/h)	15	355	20	5	455	0	45	10	15	10	5	25
Sign Control		Free			Free			Stop			Stop	
Grade		0%			0%			0%			0%	
Peak Hour Factor	0.92	0.92	0.92	0.92	0.92	0.92	0.92	0.92	0.92	0.92	0.92	0.92
Hourly flow rate (vph)	16	386	22	5	495	0	49	11	16	11	5	27
Pedestrians												
Lane Width (m)												
Walking Speed (m/s)												
Percent Blockage												
Right turn flare (veh)												
Median type		None			None							
Median storage veh												
Upstream signal (m)												
pX, platoon unblocked												
vC, conflicting volume	495			408			964	934	397	944	945	495
vC1, stage 1 conf vol												
vC2, stage 2 conf vol												
vCu, unblocked vol	495			408			964	934	397	944	945	495
tC, single (s)	4.1			4.1			7.1	6.5	6.2	7.1	6.5	6.2
tC, 2 stage (s)												
tF (s)	2.2			2.2			3.5	4.0	3.3	3.5	4.0	3.3
p0 queue free %	99			100			77	96	98	95	98	95
cM capacity (veh/h)	1069			1151			217	261	652	225	257	575
Direction, Lane #	EB 1	EB 2	WB 1	WB 2	NB 1	SB 1						
Volume Total	16	408	5	495	76	43						
Volume Left	16	0	5	0	49	11						
Volume Right	0	22	0	0	16	27						
cSH	1069	1700	1151	1700	260	373						
Volume to Capacity	0.01	0.24	0.00	0.29	0.29	0.12						
Queue Length 95th (m)	0.4	0.0	0.1	0.0	9.4	3.1						
Control Delay (s)	8.4	0.0	8.1	0.0	24.5	15.9						
Lane LOS	A		A		C	C						
Approach Delay (s)	0.3		0.1		24.5	15.9						
Approach LOS					C	C						
Intersection Summary												
Average Delay			2.6									
Intersection Capacity Utilization			39.4%		ICU Level of Service				A			
Analysis Period (min)			15									



















HCM Unsignalized Intersection Capacity Analysis
102: Clover Ave. & Wyandotte St.

AM Peak Hour
2027 Total Future Conditions

													
Movement	EBL	EBT	EBR	WBL	WBT	WBR	NBL	NBT	NBR	SBL	SBT	SBR	
Lane Configurations													
Traffic Volume (veh/h)	5	355	15	0	400	25	40	15	10	15	5	5	
Future Volume (Veh/h)	5	355	15	0	400	25	40	15	10	15	5	5	
Sign Control	Free			Free			Stop			Stop			
Grade	0%			0%			0%			0%			
Peak Hour Factor	0.92	0.92	0.92	0.92	0.92	0.92	0.92	0.92	0.92	0.92	0.92	0.92	
Hourly flow rate (vph)	5	386	16	0	435	27	43	16	11	16	5	5	
Pedestrians													
Lane Width (m)													
Walking Speed (m/s)													
Percent Blockage													
Right turn flare (veh)													
Median type	None					None							
Median storage (veh)													
Upstream signal (m)													
pX, platoon unblocked													
vC, conflicting volume	462			402			846	866	394	864	860	448	
vC1, stage 1 conf vol													
vC2, stage 2 conf vol													
vCu, unblocked vol	462			402			846	866	394	864	860	448	
tC, single (s)	4.1			4.1			7.1	6.5	6.2	7.1	6.5	6.2	
tC, 2 stage (s)													
tF (s)	2.2			2.2			3.5	4.0	3.3	3.5	4.0	3.3	
p0 queue free %	100			100			84	94	98	94	98	99	
cM capacity (veh/h)	1099			1157			275	290	655	258	292	610	
Direction, Lane #	EB 1	EB 2	WB 1	WB 2	NB 1	SB 1							
Volume Total	5	402	0	462	70	26							
Volume Left	5	0	0	0	43	16							
Volume Right	0	16	0	27	11	5							
cSH	1099	1700	1700	1700	307	298							
Volume to Capacity	0.00	0.24	0.00	0.27	0.23	0.09							
Queue Length 95th (m)	0.1	0.0	0.0	0.0	6.9	2.3							
Control Delay (s)	8.3	0.0	0.0	0.0	20.2	18.3							
Lane LOS	A				C	C							
Approach Delay (s)	0.1		0.0		20.2	18.3							
Approach LOS					C	C							
Intersection Summary													
Average Delay			2.0										
Intersection Capacity Utilization			33.6%		ICU Level of Service			A					
Analysis Period (min)			15										



















HCM Unsignalized Intersection Capacity Analysis
101: Florence Ave. & Wyandotte St.

PM Peak Hour
2027 Total Future Conditions

												
Movement	EBL	EBT	EBR	WBL	WBT	WBR	NBL	NBT	NBR	SBL	SBT	SBR
Lane Configurations												
Traffic Volume (veh/h)	25	520	45	15	330	15	35	5	10	15	10	20
Future Volume (Veh/h)	25	520	45	15	330	15	35	5	10	15	10	20
Sign Control		Free			Free			Stop			Stop	
Grade		0%			0%			0%			0%	
Peak Hour Factor	0.92	0.92	0.92	0.92	0.92	0.92	0.92	0.92	0.92	0.92	0.92	0.92
Hourly flow rate (vph)	27	565	49	16	359	16	38	5	11	16	11	22
Pedestrians												
Lane Width (m)												
Walking Speed (m/s)												
Percent Blockage												
Right turn flare (veh)												
Median type		None			None							
Median storage veh												
Upstream signal (m)												
pX, platoon unblocked												
vC, conflicting volume	375			614			1062	1050	590	1032	1067	367
vC1, stage 1 conf vol												
vC2, stage 2 conf vol												
vCu, unblocked vol	375			614			1062	1050	590	1032	1067	367
tC, single (s)	4.1			4.1			7.1	6.5	6.2	7.1	6.5	6.2
tC, 2 stage (s)												
tF (s)	2.2			2.2			3.5	4.0	3.3	3.5	4.0	3.3
p0 queue free %	98			98			79	98	98	92	95	97
cM capacity (veh/h)	1183			965			182	218	508	197	213	678
Direction, Lane #	EB 1	EB 2	WB 1	WB 2	NB 1	SB 1						
Volume Total	27	614	16	375	54	49						
Volume Left	27	0	16	0	38	16						
Volume Right	0	49	0	16	11	22						
cSH	1183	1700	965	1700	213	297						
Volume to Capacity	0.02	0.36	0.02	0.22	0.25	0.17						
Queue Length 95th (m)	0.6	0.0	0.4	0.0	7.8	4.7						
Control Delay (s)	8.1	0.0	8.8	0.0	27.6	19.5						
Lane LOS	A		A		D	C						
Approach Delay (s)	0.3		0.4		27.6	19.5						
Approach LOS					D	C						
Intersection Summary												
Average Delay			2.5									
Intersection Capacity Utilization			42.2%		ICU Level of Service				A			
Analysis Period (min)			15									



















HCM Unsignalized Intersection Capacity Analysis
102: Clover Ave. & Wyandotte St.

PM Peak Hour
2027 Total Future Conditions

												
Movement	EBL	EBT	EBR	WBL	WBT	WBR	NBL	NBT	NBR	SBL	SBT	SBR
Lane Configurations												
Traffic Volume (veh/h)	10	485	40	5	325	20	30	10	10	20	10	5
Future Volume (Veh/h)	10	485	40	5	325	20	30	10	10	20	10	5
Sign Control		Free			Free			Stop			Stop	
Grade		0%			0%			0%			0%	
Peak Hour Factor	0.92	0.92	0.92	0.92	0.92	0.92	0.92	0.92	0.92	0.92	0.92	0.92
Hourly flow rate (vph)	11	527	43	5	353	22	33	11	11	22	11	5
Pedestrians												
Lane Width (m)												
Walking Speed (m/s)												
Percent Blockage												
Right turn flare (veh)												
Median type		None			None							
Median storage veh												
Upstream signal (m)												
pX, platoon unblocked												
vC, conflicting volume	375			570			944	956	548	940	966	364
vC1, stage 1 conf vol												
vC2, stage 2 conf vol												
vCu, unblocked vol	375			570			944	956	548	940	966	364
tC, single (s)	4.1			4.1			7.1	6.5	6.2	7.1	6.5	6.2
tC, 2 stage (s)												
tF (s)	2.2			2.2			3.5	4.0	3.3	3.5	4.0	3.3
p0 queue free %	99			100			86	96	98	90	96	99
cM capacity (veh/h)	1183			1002			230	255	536	229	251	681
Direction, Lane #	EB 1	EB 2	WB 1	WB 2	NB 1	SB 1						
Volume Total	11	570	5	375	55	38						
Volume Left	11	0	5	0	33	22						
Volume Right	0	43	0	22	11	5						
cSH	1183	1700	1002	1700	265	258						
Volume to Capacity	0.01	0.34	0.00	0.22	0.21	0.15						
Queue Length 95th (m)	0.2	0.0	0.1	0.0	6.1	4.1						
Control Delay (s)	8.1	0.0	8.6	0.0	22.1	21.4						
Lane LOS	A		A		C	C						
Approach Delay (s)	0.2		0.1		22.1	21.4						
Approach LOS					C	C						
Intersection Summary												
Average Delay			2.0									
Intersection Capacity Utilization			38.1%		ICU Level of Service				A			
Analysis Period (min)			15									



















HCM Unsignalized Intersection Capacity Analysis
101: Florence Ave. & Wyandotte St.

Saturday Peak Hour
2027 Total Future Conditions

												
Movement	EBL	EBT	EBR	WBL	WBT	WBR	NBL	NBT	NBR	SBL	SBT	SBR
Lane Configurations												
Traffic Volume (veh/h)	20	370	45	15	305	10	40	10	15	10	10	30
Future Volume (Veh/h)	20	370	45	15	305	10	40	10	15	10	10	30
Sign Control		Free			Free			Stop			Stop	
Grade		0%			0%			0%			0%	
Peak Hour Factor	0.92	0.92	0.92	0.92	0.92	0.92	0.92	0.92	0.92	0.92	0.92	0.92
Hourly flow rate (vph)	22	402	49	16	332	11	43	11	16	11	11	33
Pedestrians												
Lane Width (m)												
Walking Speed (m/s)												
Percent Blockage												
Right turn flare (veh)												
Median type		None			None							
Median storage veh												
Upstream signal (m)												
pX, platoon unblocked												
vC, conflicting volume	343			451			873	846	426	837	864	338
vC1, stage 1 conf vol												
vC2, stage 2 conf vol												
vCu, unblocked vol	343			451			873	846	426	837	864	338
tC, single (s)	4.1			4.1			7.1	6.5	6.2	7.1	6.5	6.2
tC, 2 stage (s)												
tF (s)	2.2			2.2			3.5	4.0	3.3	3.5	4.0	3.3
p0 queue free %	98			99			82	96	97	96	96	95
cM capacity (veh/h)	1216			1109			244	290	628	264	282	705
Direction, Lane #	EB 1	EB 2	WB 1	WB 2	NB 1	SB 1						
Volume Total	22	451	16	343	70	55						
Volume Left	22	0	16	0	43	11						
Volume Right	0	49	0	11	16	33						
cSH	1216	1700	1109	1700	292	432						
Volume to Capacity	0.02	0.27	0.01	0.20	0.24	0.13						
Queue Length 95th (m)	0.4	0.0	0.4	0.0	7.3	3.5						
Control Delay (s)	8.0	0.0	8.3	0.0	21.2	14.6						
Lane LOS	A		A		C	B						
Approach Delay (s)	0.4		0.4		21.2	14.6						
Approach LOS					C	B						
Intersection Summary												
Average Delay			2.7									
Intersection Capacity Utilization			38.1%		ICU Level of Service				A			
Analysis Period (min)			15									



















HCM Unsignalized Intersection Capacity Analysis
102: Clover Ave. & Wyandotte St.

Saturday Peak Hour
2027 Total Future Conditions

												
Movement	EBL	EBT	EBR	WBL	WBT	WBR	NBL	NBT	NBR	SBL	SBT	SBR
Lane Configurations												
Traffic Volume (veh/h)	10	335	40	5	285	20	35	10	10	20	10	15
Future Volume (Veh/h)	10	335	40	5	285	20	35	10	10	20	10	15
Sign Control		Free			Free			Stop			Stop	
Grade		0%			0%			0%			0%	
Peak Hour Factor	0.92	0.92	0.92	0.92	0.92	0.92	0.92	0.92	0.92	0.92	0.92	0.92
Hourly flow rate (vph)	11	364	43	5	310	22	38	11	11	22	11	16
Pedestrians												
Lane Width (m)												
Walking Speed (m/s)												
Percent Blockage												
Right turn flare (veh)												
Median type		None			None							
Median storage veh												
Upstream signal (m)												
pX, platoon unblocked												
vC, conflicting volume	332			407			749	750	386	734	760	321
vC1, stage 1 conf vol												
vC2, stage 2 conf vol												
vCu, unblocked vol	332			407			749	750	386	734	760	321
tC, single (s)	4.1			4.1			7.1	6.5	6.2	7.1	6.5	6.2
tC, 2 stage (s)												
tF (s)	2.2			2.2			3.5	4.0	3.3	3.5	4.0	3.3
p0 queue free %	99			100			88	97	98	93	97	98
cM capacity (veh/h)	1227			1152			309	336	662	319	331	720
Direction, Lane #	EB 1	EB 2	WB 1	WB 2	NB 1	SB 1						
Volume Total	11	407	5	332	60	49						
Volume Left	11	0	5	0	38	22						
Volume Right	0	43	0	22	11	16						
cSH	1227	1700	1152	1700	349	394						
Volume to Capacity	0.01	0.24	0.00	0.20	0.17	0.12						
Queue Length 95th (m)	0.2	0.0	0.1	0.0	4.9	3.4						
Control Delay (s)	8.0	0.0	8.1	0.0	17.5	15.4						
Lane LOS	A		A		C	C						
Approach Delay (s)	0.2		0.1		17.5	15.4						
Approach LOS					C	C						
Intersection Summary												
Average Delay			2.2									
Intersection Capacity Utilization			31.3%		ICU Level of Service				A			
Analysis Period (min)			15									



















HCM Unsignalized Intersection Capacity Analysis
101: Florence Ave. & Wyandotte St.

AM Peak Hour
2032 Total Future Conditions

												
Movement	EBL	EBT	EBR	WBL	WBT	WBR	NBL	NBT	NBR	SBL	SBT	SBR
Lane Configurations												
Traffic Volume (veh/h)	15	370	20	5	475	0	45	10	15	10	5	25
Future Volume (Veh/h)	15	370	20	5	475	0	45	10	15	10	5	25
Sign Control		Free			Free			Stop			Stop	
Grade		0%			0%			0%			0%	
Peak Hour Factor	0.92	0.92	0.92	0.92	0.92	0.92	0.92	0.92	0.92	0.92	0.92	0.92
Hourly flow rate (vph)	16	402	22	5	516	0	49	11	16	11	5	27
Pedestrians												
Lane Width (m)												
Walking Speed (m/s)												
Percent Blockage												
Right turn flare (veh)												
Median type		None			None							
Median storage (veh)												
Upstream signal (m)												
pX, platoon unblocked												
vC, conflicting volume	516			424			1000	971	413	982	982	516
vC1, stage 1 conf vol												
vC2, stage 2 conf vol												
vCu, unblocked vol	516			424			1000	971	413	982	982	516
tC, single (s)	4.1			4.1			7.1	6.5	6.2	7.1	6.5	6.2
tC, 2 stage (s)												
tF (s)	2.2			2.2			3.5	4.0	3.3	3.5	4.0	3.3
p0 queue free %	98			100			76	96	97	95	98	95
cM capacity (veh/h)	1050			1135			205	248	639	212	244	559
Direction, Lane #	EB 1	EB 2	WB 1	WB 2	NB 1	SB 1						
Volume Total	16	424	5	516	76	43						
Volume Left	16	0	5	0	49	11						
Volume Right	0	22	0	0	16	27						
cSH	1050	1700	1135	1700	246	356						
Volume to Capacity	0.02	0.25	0.00	0.30	0.31	0.12						
Queue Length 95th (m)	0.4	0.0	0.1	0.0	10.1	3.3						
Control Delay (s)	8.5	0.0	8.2	0.0	26.0	16.5						
Lane LOS	A		A		D	C						
Approach Delay (s)	0.3		0.1		26.0	16.5						
Approach LOS					D	C						
Intersection Summary												
Average Delay			2.7									
Intersection Capacity Utilization			40.5%		ICU Level of Service				A			
Analysis Period (min)			15									



















HCM Unsignalized Intersection Capacity Analysis
102: Clover Ave. & Wyandotte St.

AM Peak Hour
2032 Total Future Conditions

												
Movement	EBL	EBT	EBR	WBL	WBT	WBR	NBL	NBT	NBR	SBL	SBT	SBR
Lane Configurations												
Traffic Volume (veh/h)	10	370	15	0	420	30	40	15	10	15	5	5
Future Volume (Veh/h)	10	370	15	0	420	30	40	15	10	15	5	5
Sign Control		Free			Free			Stop			Stop	
Grade		0%			0%			0%			0%	
Peak Hour Factor	0.92	0.92	0.92	0.92	0.92	0.92	0.92	0.92	0.92	0.92	0.92	0.92
Hourly flow rate (vph)	11	402	16	0	457	33	43	16	11	16	5	5
Pedestrians												
Lane Width (m)												
Walking Speed (m/s)												
Percent Blockage												
Right turn flare (veh)												
Median type	None					None						
Median storage veh												
Upstream signal (m)												
pX, platoon unblocked												
vC, conflicting volume	490			418			896	922	410	916	914	474
vC1, stage 1 conf vol												
vC2, stage 2 conf vol												
vCu, unblocked vol	490			418			896	922	410	916	914	474
tC, single (s)	4.1			4.1			7.1	6.5	6.2	7.1	6.5	6.2
tC, 2 stage (s)												
tF (s)	2.2			2.2			3.5	4.0	3.3	3.5	4.0	3.3
p0 queue free %	99			100			83	94	98	93	98	99
cM capacity (veh/h)	1073			1141			253	267	642	235	270	591
Direction, Lane #	EB 1	EB 2	WB 1	WB 2	NB 1	SB 1						
Volume Total	11	418	0	490	70	26						
Volume Left	11	0	0	0	43	16						
Volume Right	0	16	0	33	11	5						
cSH	1073	1700	1700	1700	283	274						
Volume to Capacity	0.01	0.25	0.00	0.29	0.25	0.09						
Queue Length 95th (m)	0.2	0.0	0.0	0.0	7.6	2.5						
Control Delay (s)	8.4	0.0	0.0	0.0	21.8	19.5						
Lane LOS	A				C	C						
Approach Delay (s)	0.2		0.0		21.8	19.5						
Approach LOS					C	C						
Intersection Summary												
Average Delay			2.1									
Intersection Capacity Utilization			35.0%	ICU Level of Service	A							
Analysis Period (min)			15									



















HCM Unsignalized Intersection Capacity Analysis
101: Florence Ave. & Wyandotte St.

PM Peak Hour
2032 Total Future Conditions

												
Movement	EBL	EBT	EBR	WBL	WBT	WBR	NBL	NBT	NBR	SBL	SBT	SBR
Lane Configurations												
Traffic Volume (veh/h)	30	545	45	15	345	20	35	5	10	15	10	20
Future Volume (Veh/h)	30	545	45	15	345	20	35	5	10	15	10	20
Sign Control		Free			Free			Stop			Stop	
Grade		0%			0%			0%			0%	
Peak Hour Factor	0.92	0.92	0.92	0.92	0.92	0.92	0.92	0.92	0.92	0.92	0.92	0.92
Hourly flow rate (vph)	33	592	49	16	375	22	38	5	11	16	11	22
Pedestrians												
Lane Width (m)												
Walking Speed (m/s)												
Percent Blockage												
Right turn flare (veh)												
Median type	None					None						
Median storage veh												
Upstream signal (m)												
pX, platoon unblocked												
vC, conflicting volume	397			641			1117	1112	616	1090	1125	386
vC1, stage 1 conf vol												
vC2, stage 2 conf vol												
vCu, unblocked vol	397			641			1117	1112	616	1090	1125	386
tC, single (s)	4.1			4.1			7.1	6.5	6.2	7.1	6.5	6.2
tC, 2 stage (s)												
tF (s)	2.2			2.2			3.5	4.0	3.3	3.5	4.0	3.3
p0 queue free %	97			98			77	97	98	91	94	97
cM capacity (veh/h)	1162			943			165	200	490	179	196	662
Direction, Lane #	EB 1	EB 2	WB 1	WB 2	NB 1	SB 1						
Volume Total	33	641	16	397	54	49						
Volume Left	33	0	16	0	38	16						
Volume Right	0	49	0	22	11	22						
cSH	1162	1700	943	1700	194	274						
Volume to Capacity	0.03	0.38	0.02	0.23	0.28	0.18						
Queue Length 95th (m)	0.7	0.0	0.4	0.0	8.7	5.1						
Control Delay (s)	8.2	0.0	8.9	0.0	30.5	21.0						
Lane LOS	A		A		D	C						
Approach Delay (s)	0.4		0.3		30.5	21.0						
Approach LOS					D	C						
Intersection Summary												
Average Delay			2.6									
Intersection Capacity Utilization			43.5%		ICU Level of Service				A			
Analysis Period (min)			15									



















HCM Unsignalized Intersection Capacity Analysis
102: Clover Ave. & Wyandotte St.

PM Peak Hour
2032 Total Future Conditions

												
Movement	EBL	EBT	EBR	WBL	WBT	WBR	NBL	NBT	NBR	SBL	SBT	SBR
Lane Configurations												
Traffic Volume (veh/h)	10	505	40	5	335	20	30	10	10	25	10	10
Future Volume (Veh/h)	10	505	40	5	335	20	30	10	10	25	10	10
Sign Control		Free			Free			Stop			Stop	
Grade		0%			0%			0%			0%	
Peak Hour Factor	0.92	0.92	0.92	0.92	0.92	0.92	0.92	0.92	0.92	0.92	0.92	0.92
Hourly flow rate (vph)	11	549	43	5	364	22	33	11	11	27	11	11
Pedestrians												
Lane Width (m)												
Walking Speed (m/s)												
Percent Blockage												
Right turn flare (veh)												
Median type	None					None						
Median storage (veh)												
Upstream signal (m)												
pX, platoon unblocked												
vC, conflicting volume	386			592			983	988	570	972	999	375
vC1, stage 1 conf vol												
vC2, stage 2 conf vol												
vCu, unblocked vol	386			592			983	988	570	972	999	375
tC, single (s)	4.1			4.1			7.1	6.5	6.2	7.1	6.5	6.2
tC, 2 stage (s)												
tF (s)	2.2			2.2			3.5	4.0	3.3	3.5	4.0	3.3
p0 queue free %	99			99			85	95	98	88	95	98
cM capacity (veh/h)	1172			984			214	243	521	217	240	671
Direction, Lane #	EB 1	EB 2	WB 1	WB 2	NB 1	SB 1						
Volume Total	11	592	5	386	55	49						
Volume Left	11	0	5	0	33	27						
Volume Right	0	43	0	22	11	11						
cSH	1172	1700	984	1700	249	262						
Volume to Capacity	0.01	0.35	0.01	0.23	0.22	0.19						
Queue Length 95th (m)	0.2	0.0	0.1	0.0	6.6	5.4						
Control Delay (s)	8.1	0.0	8.7	0.0	23.5	21.9						
Lane LOS	A		A		C	C						
Approach Delay (s)	0.1		0.1		23.5	21.9						
Approach LOS					C	C						
Intersection Summary												
Average Delay			2.3									
Intersection Capacity Utilization			39.2%		ICU Level of Service				A			
Analysis Period (min)			15									



















HCM Unsignalized Intersection Capacity Analysis
101: Florence Ave. & Wyandotte St.

Saturday Peak Hour
2032 Total Future Conditions

												
Movement	EBL	EBT	EBR	WBL	WBT	WBR	NBL	NBT	NBR	SBL	SBT	SBR
Lane Configurations												
Traffic Volume (veh/h)	20	385	45	15	315	10	40	10	15	10	10	30
Future Volume (Veh/h)	20	385	45	15	315	10	40	10	15	10	10	30
Sign Control		Free			Free			Stop			Stop	
Grade		0%			0%			0%			0%	
Peak Hour Factor	0.92	0.92	0.92	0.92	0.92	0.92	0.92	0.92	0.92	0.92	0.92	0.92
Hourly flow rate (vph)	22	418	49	16	342	11	43	11	16	11	11	33
Pedestrians												
Lane Width (m)												
Walking Speed (m/s)												
Percent Blockage												
Right turn flare (veh)												
Median type		None			None							
Median storage veh												
Upstream signal (m)												
pX, platoon unblocked												
vC, conflicting volume	353			467			899	872	442	863	890	348
vC1, stage 1 conf vol												
vC2, stage 2 conf vol												
vCu, unblocked vol	353			467			899	872	442	863	890	348
tC, single (s)	4.1			4.1			7.1	6.5	6.2	7.1	6.5	6.2
tC, 2 stage (s)												
tF (s)	2.2			2.2			3.5	4.0	3.3	3.5	4.0	3.3
p0 queue free %	98			99			82	96	97	96	96	95
cM capacity (veh/h)	1206			1094			234	280	615	253	273	696
Direction, Lane #	EB 1	EB 2	WB 1	WB 2	NB 1	SB 1						
Volume Total	22	467	16	353	70	55						
Volume Left	22	0	16	0	43	11						
Volume Right	0	49	0	11	16	33						
cSH	1206	1700	1094	1700	281	419						
Volume to Capacity	0.02	0.27	0.01	0.21	0.25	0.13						
Queue Length 95th (m)	0.4	0.0	0.4	0.0	7.7	3.6						
Control Delay (s)	8.0	0.0	8.3	0.0	22.0	14.9						
Lane LOS	A		A		C	B						
Approach Delay (s)	0.4		0.4		22.0	14.9						
Approach LOS					C	B						
Intersection Summary												
Average Delay			2.7									
Intersection Capacity Utilization			38.9%		ICU Level of Service				A			
Analysis Period (min)			15									





















HCM Unsignalized Intersection Capacity Analysis
102: Clover Ave. & Wyandotte St.

Saturday Peak Hour
2032 Total Future Conditions

												
Movement	EBL	EBT	EBR	WBL	WBT	WBR	NBL	NBT	NBR	SBL	SBT	SBR
Lane Configurations												
Traffic Volume (veh/h)	10	350	40	5	295	20	35	10	10	25	10	15
Future Volume (Veh/h)	10	350	40	5	295	20	35	10	10	25	10	15
Sign Control		Free			Free			Stop			Stop	
Grade		0%			0%			0%			0%	
Peak Hour Factor	0.92	0.92	0.92	0.92	0.92	0.92	0.92	0.92	0.92	0.92	0.92	0.92
Hourly flow rate (vph)	11	380	43	5	321	22	38	11	11	27	11	16
Pedestrians												
Lane Width (m)												
Walking Speed (m/s)												
Percent Blockage												
Right turn flare (veh)												
Median type		None			None							
Median storage veh												
Upstream signal (m)												
pX, platoon unblocked												
vC, conflicting volume	343			423			776	776	402	760	787	332
vC1, stage 1 conf vol												
vC2, stage 2 conf vol												
vCu, unblocked vol	343			423			776	776	402	760	787	332
tC, single (s)	4.1			4.1			7.1	6.5	6.2	7.1	6.5	6.2
tC, 2 stage (s)												
tF (s)	2.2			2.2			3.5	4.0	3.3	3.5	4.0	3.3
p0 queue free %	99			100			87	97	98	91	97	98
cM capacity (veh/h)	1216			1136			296	324	649	305	319	710
Direction, Lane #	EB 1	EB 2	WB 1	WB 2	NB 1	SB 1						
Volume Total	11	423	5	343	60	54						
Volume Left	11	0	5	0	38	27						
Volume Right	0	43	0	22	11	16						
cSH	1216	1700	1136	1700	335	371						
Volume to Capacity	0.01	0.25	0.00	0.20	0.18	0.15						
Queue Length 95th (m)	0.2	0.0	0.1	0.0	5.1	4.0						
Control Delay (s)	8.0	0.0	8.2	0.0	18.1	16.3						
Lane LOS	A		A		C	C						
Approach Delay (s)	0.2		0.1		18.1	16.3						
Approach LOS					C	C						
Intersection Summary												
Average Delay			2.3									
Intersection Capacity Utilization			31.8%		ICU Level of Service				A			
Analysis Period (min)			15									





















HCM Unsignalized Intersection Capacity Analysis
101: Florence Ave. & Wyandotte St.

AM Peak Hour
2027 Total Future Conditions

												
Movement	EBL	EBT	EBR	WBL	WBT	WBR	NBL	NBT	NBR	SBL	SBT	SBR
Lane Configurations												
Traffic Volume (veh/h)	15	355	20	5	455	0	45	45	15	10	25	25
Future Volume (Veh/h)	15	355	20	5	455	0	45	45	15	10	25	25
Sign Control	Free			Free			Stop			Stop		
Grade	0%			0%			0%			0%		
Peak Hour Factor	0.92	0.92	0.92	0.92	0.92	0.92	0.92	0.92	0.92	0.92	0.92	0.92
Hourly flow rate (vph)	16	386	22	5	495	0	49	49	16	11	27	27
Pedestrians												
Lane Width (m)												
Walking Speed (m/s)												
Percent Blockage												
Right turn flare (veh)												
Median type	None			None								
Median storage veh												
Upstream signal (m)												
pX, platoon unblocked												
vC, conflicting volume	495			408			974	934	397	964	945	495
vC1, stage 1 conf vol												
vC2, stage 2 conf vol												
vCu, unblocked vol	495			408			974	934	397	964	945	495
tC, single (s)	4.1			4.1			7.1	6.5	6.2	7.1	6.5	6.2
tC, 2 stage (s)												
tF (s)	2.2			2.2			3.5	4.0	3.3	3.5	4.0	3.3
p0 queue free %	99			100			75	81	98	94	89	95
cM capacity (veh/h)	1069			1151			199	261	652	193	257	575
Direction, Lane #	EB 1	EB 2	WB 1	WB 2	NB 1	NB 2	SB 1	SB 2				
Volume Total	16	408	5	495	49	65	11	54				
Volume Left	16	0	5	0	49	0	11	0				
Volume Right	0	22	0	0	0	16	0	27				
cSH	1069	1700	1151	1700	199	306	193	355				
Volume to Capacity	0.01	0.24	0.00	0.29	0.25	0.21	0.06	0.15				
Queue Length 95th (m)	0.4	0.0	0.1	0.0	7.4	6.3	1.4	4.2				
Control Delay (s)	8.4	0.0	8.1	0.0	28.8	19.9	24.7	17.0				
Lane LOS	A		A		D	C	C	C				
Approach Delay (s)	0.3		0.1		23.7		18.3					
Approach LOS					C		C					
Intersection Summary												
Average Delay			3.7									
Intersection Capacity Utilization			39.8%	ICU Level of Service				A				
Analysis Period (min)			15									





















HCM Unsignalized Intersection Capacity Analysis
102: Clover Ave. & Wyandotte St.

AM Peak Hour
2027 Total Future Conditions

													
Movement	EBL	EBT	EBR	WBL	WBT	WBR	NBL	NBT	NBR	SBL	SBT	SBR	
Lane Configurations													
Traffic Volume (veh/h)	5	355	15	0	400	25	40	120	10	15	65	5	
Future Volume (Veh/h)	5	355	15	0	400	25	40	120	10	15	65	5	
Sign Control	Free			Free			Stop			Stop			
Grade	0%			0%			0%			0%			
Peak Hour Factor	0.92	0.92	0.92	0.92	0.92	0.92	0.92	0.92	0.92	0.92	0.92	0.92	
Hourly flow rate (vph)	5	386	16	0	435	27	43	130	11	16	71	5	
Pedestrians													
Lane Width (m)													
Walking Speed (m/s)													
Percent Blockage													
Right turn flare (veh)													
Median type	None			None									
Median storage veh													
Upstream signal (m)													
pX, platoon unblocked													
vC, conflicting volume	462			402			880	866	394	920	860	448	
vC1, stage 1 conf vol													
vC2, stage 2 conf vol													
vCu, unblocked vol	462			402			880	866	394	920	860	448	
tC, single (s)	4.1			4.1			7.1	6.5	6.2	7.1	6.5	6.2	
tC, 2 stage (s)													
tF (s)	2.2			2.2			3.5	4.0	3.3	3.5	4.0	3.3	
p0 queue free %	100			100			80	55	98	90	76	99	
cM capacity (veh/h)	1099			1157			215	290	655	160	292	610	
Direction, Lane #	EB 1	EB 2	WB 1	WB 2	NB 1	NB 2	SB 1	SB 2					
Volume Total	5	402	0	462	43	141	16	76					
Volume Left	5	0	0	0	43	0	16	0					
Volume Right	0	16	0	27	0	11	0	5					
cSH	1099	1700	1700	1700	215	303	160	302					
Volume to Capacity	0.00	0.24	0.00	0.27	0.20	0.47	0.10	0.25					
Queue Length 95th (m)	0.1	0.0	0.0	0.0	5.8	18.7	2.6	7.8					
Control Delay (s)	8.3	0.0	0.0	0.0	25.9	26.8	30.0	20.9					
Lane LOS	A				D	D	D	C					
Approach Delay (s)	0.1		0.0		26.6		22.4						
Approach LOS					D		C						
Intersection Summary													
Average Delay			6.1										
Intersection Capacity Utilization			41.7%	ICU Level of Service					A				
Analysis Period (min)			15										





















HCM Unsignalized Intersection Capacity Analysis
101: Florence Ave. & Wyandotte St.

PM Peak Hour
2027 Total Future Conditions

												
Movement	EBL	EBT	EBR	WBL	WBT	WBR	NBL	NBT	NBR	SBL	SBT	SBR
Lane Configurations												
Traffic Volume (veh/h)	25	520	45	15	330	15	35	30	10	15	60	20
Future Volume (Veh/h)	25	520	45	15	330	15	35	30	10	15	60	20
Sign Control		Free			Free			Stop			Stop	
Grade		0%			0%			0%			0%	
Peak Hour Factor	0.92	0.92	0.92	0.92	0.92	0.92	0.92	0.92	0.92	0.92	0.92	0.92
Hourly flow rate (vph)	27	565	49	16	359	16	38	33	11	16	65	22
Pedestrians												
Lane Width (m)												
Walking Speed (m/s)												
Percent Blockage												
Right turn flare (veh)												
Median type		None			None							
Median storage veh												
Upstream signal (m)												
pX, platoon unblocked												
vC, conflicting volume	375			614			1089	1050	590	1046	1067	367
vC1, stage 1 conf vol												
vC2, stage 2 conf vol												
vCu, unblocked vol	375			614			1089	1050	590	1046	1067	367
tC, single (s)	4.1			4.1			7.1	6.5	6.2	7.1	6.5	6.2
tC, 2 stage (s)												
tF (s)	2.2			2.2			3.5	4.0	3.3	3.5	4.0	3.3
p0 queue free %	98			98			73	85	98	91	70	97
cM capacity (veh/h)	1183			965			139	218	508	173	213	678
Direction, Lane #	EB 1	EB 2	WB 1	WB 2	NB 1	NB 2	SB 1	SB 2				
Volume Total	27	614	16	375	38	44	16	87				
Volume Left	27	0	16	0	38	0	16	0				
Volume Right	0	49	0	16	0	11	0	22				
cSH	1183	1700	965	1700	139	254	173	258				
Volume to Capacity	0.02	0.36	0.02	0.22	0.27	0.17	0.09	0.34				
Queue Length 95th (m)	0.6	0.0	0.4	0.0	8.4	4.9	2.4	11.4				
Control Delay (s)	8.1	0.0	8.8	0.0	40.5	22.1	27.9	25.9				
Lane LOS	A		A		E	C	D	D				
Approach Delay (s)	0.3		0.4		30.6		26.2					
Approach LOS					D		D					
Intersection Summary												
Average Delay			4.6									
Intersection Capacity Utilization			45.4%		ICU Level of Service			A				
Analysis Period (min)			15									





















HCM Unsignalized Intersection Capacity Analysis
102: Clover Ave. & Wyandotte St.

PM Peak Hour
2027 Total Future Conditions

												
Movement	EBL	EBT	EBR	WBL	WBT	WBR	NBL	NBT	NBR	SBL	SBT	SBR
Lane Configurations												
Traffic Volume (veh/h)	10	485	40	5	325	20	30	90	10	20	155	5
Future Volume (Veh/h)	10	485	40	5	325	20	30	90	10	20	155	5
Sign Control		Free			Free			Stop			Stop	
Grade		0%			0%			0%			0%	
Peak Hour Factor	0.92	0.92	0.92	0.92	0.92	0.92	0.92	0.92	0.92	0.92	0.92	0.92
Hourly flow rate (vph)	11	527	43	5	353	22	33	98	11	22	168	5
Pedestrians												
Lane Width (m)												
Walking Speed (m/s)												
Percent Blockage												
Right turn flare (veh)												
Median type		None			None							
Median storage veh												
Upstream signal (m)												
pX, platoon unblocked												
vC, conflicting volume	375			570			1022	956	548	983	966	364
vC1, stage 1 conf vol												
vC2, stage 2 conf vol												
vCu, unblocked vol	375			570			1022	956	548	983	966	364
tC, single (s)	4.1			4.1			7.1	6.5	6.2	7.1	6.5	6.2
tC, 2 stage (s)												
tF (s)	2.2			2.2			3.5	4.0	3.3	3.5	4.0	3.3
p0 queue free %	99			100			66	61	98	86	33	99
cM capacity (veh/h)	1183			1002			97	255	536	155	251	681
Direction, Lane #	EB 1	EB 2	WB 1	WB 2	NB 1	NB 2	SB 1	SB 2				
Volume Total	11	570	5	375	33	109	22	173				
Volume Left	11	0	5	0	33	0	22	0				
Volume Right	0	43	0	22	0	11	0	5				
cSH	1183	1700	1002	1700	97	269	155	256				
Volume to Capacity	0.01	0.34	0.00	0.22	0.34	0.41	0.14	0.68				
Queue Length 95th (m)	0.2	0.0	0.1	0.0	10.6	15.0	3.9	35.2				
Control Delay (s)	8.1	0.0	8.6	0.0	60.1	27.2	32.1	44.2				
Lane LOS	A		A		F	D	D	E				
Approach Delay (s)	0.2		0.1		34.9		42.9					
Approach LOS					D		E					
Intersection Summary												
Average Delay			10.4									
Intersection Capacity Utilization			49.7%		ICU Level of Service			A				
Analysis Period (min)			15									





















HCM Unsignalized Intersection Capacity Analysis
101: Florence Ave. & Wyandotte St.

Saturday Peak Hour
2027 Total Future Conditions

												
Movement	EBL	EBT	EBR	WBL	WBT	WBR	NBL	NBT	NBR	SBL	SBT	SBR
Lane Configurations												
Traffic Volume (veh/h)	20	370	45	15	305	10	40	30	15	10	50	30
Future Volume (Veh/h)	20	370	45	15	305	10	40	30	15	10	50	30
Sign Control		Free			Free			Stop			Stop	
Grade		0%			0%			0%			0%	
Peak Hour Factor	0.92	0.92	0.92	0.92	0.92	0.92	0.92	0.92	0.92	0.92	0.92	0.92
Hourly flow rate (vph)	22	402	49	16	332	11	43	33	16	11	54	33
Pedestrians												
Lane Width (m)												
Walking Speed (m/s)												
Percent Blockage												
Right turn flare (veh)												
Median type		None			None							
Median storage veh												
Upstream signal (m)												
pX, platoon unblocked												
vC, conflicting volume	343			451			894	846	426	848	864	338
vC1, stage 1 conf vol												
vC2, stage 2 conf vol												
vCu, unblocked vol	343			451			894	846	426	848	864	338
tC, single (s)	4.1			4.1			7.1	6.5	6.2	7.1	6.5	6.2
tC, 2 stage (s)												
tF (s)	2.2			2.2			3.5	4.0	3.3	3.5	4.0	3.3
p0 queue free %	98			99			79	89	97	95	81	95
cM capacity (veh/h)	1216			1109			208	290	628	244	282	705
Direction, Lane #	EB 1	EB 2	WB 1	WB 2	NB 1	NB 2	SB 1	SB 2				
Volume Total	22	451	16	343	43	49	11	87				
Volume Left	22	0	16	0	43	0	11	0				
Volume Right	0	49	0	11	0	16	0	33				
cSH	1216	1700	1109	1700	208	352	244	365				
Volume to Capacity	0.02	0.27	0.01	0.20	0.21	0.14	0.05	0.24				
Queue Length 95th (m)	0.4	0.0	0.4	0.0	6.0	3.8	1.1	7.3				
Control Delay (s)	8.0	0.0	8.3	0.0	26.8	16.9	20.4	17.9				
Lane LOS	A		A		D	C	C	C				
Approach Delay (s)	0.4		0.4		21.5		18.2					
Approach LOS					C		C					
Intersection Summary												
Average Delay			4.0									
Intersection Capacity Utilization			37.8%		ICU Level of Service			A				
Analysis Period (min)			15									





















HCM Unsignalized Intersection Capacity Analysis
102: Clover Ave. & Wyandotte St.

Saturday Peak Hour
2027 Total Future Conditions

												
Movement	EBL	EBT	EBR	WBL	WBT	WBR	NBL	NBT	NBR	SBL	SBT	SBR
Lane Configurations												
Traffic Volume (veh/h)	10	335	40	5	285	20	35	75	10	20	130	15
Future Volume (Veh/h)	10	335	40	5	285	20	35	75	10	20	130	15
Sign Control		Free			Free			Stop			Stop	
Grade		0%			0%			0%			0%	
Peak Hour Factor	0.92	0.92	0.92	0.92	0.92	0.92	0.92	0.92	0.92	0.92	0.92	0.92
Hourly flow rate (vph)	11	364	43	5	310	22	38	82	11	22	141	16
Pedestrians												
Lane Width (m)												
Walking Speed (m/s)												
Percent Blockage												
Right turn flare (veh)												
Median type		None			None							
Median storage veh												
Upstream signal (m)												
pX, platoon unblocked												
vC, conflicting volume	332			407			814	750	386	769	760	321
vC1, stage 1 conf vol												
vC2, stage 2 conf vol												
vCu, unblocked vol	332			407			814	750	386	769	760	321
tC, single (s)	4.1			4.1			7.1	6.5	6.2	7.1	6.5	6.2
tC, 2 stage (s)												
tF (s)	2.2			2.2			3.5	4.0	3.3	3.5	4.0	3.3
p0 queue free %	99			100			80	76	98	91	57	98
cM capacity (veh/h)	1227			1152			192	336	662	251	331	720
Direction, Lane #	EB 1	EB 2	WB 1	WB 2	NB 1	NB 2	SB 1	SB 2				
Volume Total	11	407	5	332	38	93	22	157				
Volume Left	11	0	5	0	38	0	22	0				
Volume Right	0	43	0	22	0	11	0	16				
cSH	1227	1700	1152	1700	192	357	251	350				
Volume to Capacity	0.01	0.24	0.00	0.20	0.20	0.26	0.09	0.45				
Queue Length 95th (m)	0.2	0.0	0.1	0.0	5.7	8.2	2.3	17.8				
Control Delay (s)	8.0	0.0	8.1	0.0	28.4	18.6	20.7	23.4				
Lane LOS	A		A		D	C	C	C				
Approach Delay (s)	0.2		0.1		21.4		23.0					
Approach LOS					C		C					
Intersection Summary												
Average Delay			6.6									
Intersection Capacity Utilization			41.1%		ICU Level of Service			A				
Analysis Period (min)			15									





















HCM Unsignalized Intersection Capacity Analysis
101: Florence Ave. & Wyandotte St.

AM Peak Hour
2032 Total Future Conditions

												
Movement	EBL	EBT	EBR	WBL	WBT	WBR	NBL	NBT	NBR	SBL	SBT	SBR
Lane Configurations												
Traffic Volume (veh/h)	15	370	20	5	475	0	45	45	15	10	25	25
Future Volume (Veh/h)	15	370	20	5	475	0	45	45	15	10	25	25
Sign Control		Free			Free			Stop			Stop	
Grade		0%			0%			0%			0%	
Peak Hour Factor	0.92	0.92	0.92	0.92	0.92	0.92	0.92	0.92	0.92	0.92	0.92	0.92
Hourly flow rate (vph)	16	402	22	5	516	0	49	49	16	11	27	27
Pedestrians												
Lane Width (m)												
Walking Speed (m/s)												
Percent Blockage												
Right turn flare (veh)												
Median type		None			None							
Median storage veh												
Upstream signal (m)												
pX, platoon unblocked												
vC, conflicting volume	516			424			1012	971	413	1000	982	516
vC1, stage 1 conf vol												
vC2, stage 2 conf vol												
vCu, unblocked vol	516			424			1012	971	413	1000	982	516
tC, single (s)	4.1			4.1			7.1	6.5	6.2	7.1	6.5	6.2
tC, 2 stage (s)												
tF (s)	2.2			2.2			3.5	4.0	3.3	3.5	4.0	3.3
p0 queue free %	98			100			74	80	97	94	89	95
cM capacity (veh/h)	1050			1135			187	248	639	181	244	559
Direction, Lane #	EB 1	EB 2	WB 1	WB 2	NB 1	NB 2	SB 1	SB 2				
Volume Total	16	424	5	516	49	65	11	54				
Volume Left	16	0	5	0	49	0	11	0				
Volume Right	0	22	0	0	0	16	0	27				
cSH	1050	1700	1135	1700	187	292	181	340				
Volume to Capacity	0.02	0.25	0.00	0.30	0.26	0.22	0.06	0.16				
Queue Length 95th (m)	0.4	0.0	0.1	0.0	8.0	6.7	1.5	4.5				
Control Delay (s)	8.5	0.0	8.2	0.0	30.9	20.8	26.2	17.6				
Lane LOS	A		A		D	C	D	C				
Approach Delay (s)	0.3		0.1		25.2		19.0					
Approach LOS					D		C					
Intersection Summary												
Average Delay			3.8									
Intersection Capacity Utilization			40.8%		ICU Level of Service			A				
Analysis Period (min)			15									





















HCM Unsignalized Intersection Capacity Analysis
102: Clover Ave. & Wyandotte St.

AM Peak Hour
2032 Total Future Conditions

													
Movement	EBL	EBT	EBR	WBL	WBT	WBR	NBL	NBT	NBR	SBL	SBT	SBR	
Lane Configurations													
Traffic Volume (veh/h)	10	370	15	0	420	30	40	120	10	15	65	5	
Future Volume (Veh/h)	10	370	15	0	420	30	40	120	10	15	65	5	
Sign Control		Free			Free			Stop			Stop		
Grade		0%			0%			0%			0%		
Peak Hour Factor	0.92	0.92	0.92	0.92	0.92	0.92	0.92	0.92	0.92	0.92	0.92	0.92	
Hourly flow rate (vph)	11	402	16	0	457	33	43	130	11	16	71	5	
Pedestrians													
Lane Width (m)													
Walking Speed (m/s)													
Percent Blockage													
Right turn flare (veh)													
Median type	None					None							
Median storage veh													
Upstream signal (m)													
pX, platoon unblocked													
vC, conflicting volume	490			418			930	922	410	974	914	474	
vC1, stage 1 conf vol													
vC2, stage 2 conf vol													
vCu, unblocked vol	490			418			930	922	410	974	914	474	
tC, single (s)	4.1			4.1			7.1	6.5	6.2	7.1	6.5	6.2	
tC, 2 stage (s)													
tF (s)	2.2			2.2			3.5	4.0	3.3	3.5	4.0	3.3	
p0 queue free %	99			100			78	51	98	89	74	99	
cM capacity (veh/h)	1073			1141			194	267	642	139	270	591	
Direction, Lane #	EB 1	EB 2	WB 1	WB 2	NB 1	NB 2	SB 1	SB 2					
Volume Total	11	418	0	490	43	141	16	76					
Volume Left	11	0	0	0	43	0	16	0					
Volume Right	0	16	0	33	0	11	0	5					
cSH	1073	1700	1700	1700	194	280	139	280					
Volume to Capacity	0.01	0.25	0.00	0.29	0.22	0.50	0.11	0.27					
Queue Length 95th (m)	0.2	0.0	0.0	0.0	6.5	21.1	3.0	8.6					
Control Delay (s)	8.4	0.0	0.0	0.0	28.7	30.2	34.1	22.5					
Lane LOS	A				D	D	D	C					
Approach Delay (s)	0.2		0.0		29.8		24.6						
Approach LOS					D		C						
Intersection Summary													
Average Delay			6.6										
Intersection Capacity Utilization		43.1%		ICU Level of Service					A				
Analysis Period (min)			15										





















HCM Unsignalized Intersection Capacity Analysis
101: Florence Ave. & Wyandotte St.

PM Peak Hour
2032 Total Future Conditions

												
Movement	EBL	EBT	EBR	WBL	WBT	WBR	NBL	NBT	NBR	SBL	SBT	SBR
Lane Configurations												
Traffic Volume (veh/h)	30	545	45	15	345	20	35	30	10	15	60	20
Future Volume (Veh/h)	30	545	45	15	345	20	35	30	10	15	60	20
Sign Control		Free			Free			Stop			Stop	
Grade		0%			0%			0%			0%	
Peak Hour Factor	0.92	0.92	0.92	0.92	0.92	0.92	0.92	0.92	0.92	0.92	0.92	0.92
Hourly flow rate (vph)	33	592	49	16	375	22	38	33	11	16	65	22
Pedestrians												
Lane Width (m)												
Walking Speed (m/s)												
Percent Blockage												
Right turn flare (veh)												
Median type		None			None							
Median storage veh												
Upstream signal (m)												
pX, platoon unblocked												
vC, conflicting volume	397			641			1144	1112	616	1104	1125	386
vC1, stage 1 conf vol												
vC2, stage 2 conf vol												
vCu, unblocked vol	397			641			1144	1112	616	1104	1125	386
tC, single (s)	4.1			4.1			7.1	6.5	6.2	7.1	6.5	6.2
tC, 2 stage (s)												
tF (s)	2.2			2.2			3.5	4.0	3.3	3.5	4.0	3.3
p0 queue free %	97			98			69	83	98	90	67	97
cM capacity (veh/h)	1162			943			123	200	490	156	196	662
Direction, Lane #	EB 1	EB 2	WB 1	WB 2	NB 1	NB 2	SB 1	SB 2				
Volume Total	33	641	16	397	38	44	16	87				
Volume Left	33	0	16	0	38	0	16	0				
Volume Right	0	49	0	22	0	11	0	22				
cSH	1162	1700	943	1700	123	234	156	238				
Volume to Capacity	0.03	0.38	0.02	0.23	0.31	0.19	0.10	0.37				
Queue Length 95th (m)	0.7	0.0	0.4	0.0	9.6	5.4	2.7	12.7				
Control Delay (s)	8.2	0.0	8.9	0.0	46.9	23.9	30.8	28.5				
Lane LOS	A		A		E	C	D	D				
Approach Delay (s)	0.4		0.3		34.5		28.9					
Approach LOS					D		D					
Intersection Summary												
Average Delay			4.9									
Intersection Capacity Utilization			46.7%		ICU Level of Service			A				
Analysis Period (min)			15									





















HCM Unsignalized Intersection Capacity Analysis
102: Clover Ave. & Wyandotte St.

PM Peak Hour
2032 Total Future Conditions

												
Movement	EBL	EBT	EBR	WBL	WBT	WBR	NBL	NBT	NBR	SBL	SBT	SBR
Lane Configurations												
Traffic Volume (veh/h)	10	505	40	5	335	20	30	90	10	25	155	10
Future Volume (Veh/h)	10	505	40	5	335	20	30	90	10	25	155	10
Sign Control		Free			Free			Stop			Stop	
Grade		0%			0%			0%			0%	
Peak Hour Factor	0.92	0.92	0.92	0.92	0.92	0.92	0.92	0.92	0.92	0.92	0.92	0.92
Hourly flow rate (vph)	11	549	43	5	364	22	33	98	11	27	168	11
Pedestrians												
Lane Width (m)												
Walking Speed (m/s)												
Percent Blockage												
Right turn flare (veh)												
Median type		None			None							
Median storage (veh)												
Upstream signal (m)												
pX, platoon unblocked												
vC, conflicting volume	386			592			1062	988	570	1016	999	375
vC1, stage 1 conf vol												
vC2, stage 2 conf vol												
vCu, unblocked vol	386			592			1062	988	570	1016	999	375
tC, single (s)	4.1			4.1			7.1	6.5	6.2	7.1	6.5	6.2
tC, 2 stage (s)												
tF (s)	2.2			2.2			3.5	4.0	3.3	3.5	4.0	3.3
p0 queue free %	99			99			61	60	98	81	30	98
cM capacity (veh/h)	1172			984			85	243	521	144	240	671
Direction, Lane #	EB 1	EB 2	WB 1	WB 2	NB 1	NB 2	SB 1	SB 2				
Volume Total	11	592	5	386	33	109	27	179				
Volume Left	11	0	5	0	33	0	27	0				
Volume Right	0	43	0	22	0	11	0	11				
cSH	1172	1700	984	1700	85	257	144	250				
Volume to Capacity	0.01	0.35	0.01	0.23	0.39	0.42	0.19	0.72				
Queue Length 95th (m)	0.2	0.0	0.1	0.0	12.3	15.9	5.3	39.1				
Control Delay (s)	8.1	0.0	8.7	0.0	72.1	28.9	35.7	49.0				
Lane LOS	A		A		F	D	E	E				
Approach Delay (s)	0.1		0.1		39.0		47.3					
Approach LOS					E		E					
Intersection Summary												
Average Delay			11.5									
Intersection Capacity Utilization			51.1%		ICU Level of Service			A				
Analysis Period (min)			15									





















HCM Unsignalized Intersection Capacity Analysis
101: Florence Ave. & Wyandotte St.

Saturday Peak Hour
2032 Total Future Conditions

												
Movement	EBL	EBT	EBR	WBL	WBT	WBR	NBL	NBT	NBR	SBL	SBT	SBR
Lane Configurations												
Traffic Volume (veh/h)	20	385	45	15	315	10	40	30	15	10	50	30
Future Volume (Veh/h)	20	385	45	15	315	10	40	30	15	10	50	30
Sign Control		Free			Free			Stop			Stop	
Grade		0%			0%			0%			0%	
Peak Hour Factor	0.92	0.92	0.92	0.92	0.92	0.92	0.92	0.92	0.92	0.92	0.92	0.92
Hourly flow rate (vph)	22	418	49	16	342	11	43	33	16	11	54	33
Pedestrians												
Lane Width (m)												
Walking Speed (m/s)												
Percent Blockage												
Right turn flare (veh)												
Median type		None			None							
Median storage veh												
Upstream signal (m)												
pX, platoon unblocked												
vC, conflicting volume	353			467			920	872	442	874	890	348
vC1, stage 1 conf vol												
vC2, stage 2 conf vol												
vCu, unblocked vol	353			467			920	872	442	874	890	348
tC, single (s)	4.1			4.1			7.1	6.5	6.2	7.1	6.5	6.2
tC, 2 stage (s)												
tF (s)	2.2			2.2			3.5	4.0	3.3	3.5	4.0	3.3
p0 queue free %	98			99			78	88	97	95	80	95
cM capacity (veh/h)	1206			1094			198	280	615	234	273	696
Direction, Lane #	EB 1	EB 2	WB 1	WB 2	NB 1	NB 2	SB 1	SB 2				
Volume Total	22	467	16	353	43	49	11	87				
Volume Left	22	0	16	0	43	0	11	0				
Volume Right	0	49	0	11	0	16	0	33				
cSH	1206	1700	1094	1700	198	340	234	354				
Volume to Capacity	0.02	0.27	0.01	0.21	0.22	0.14	0.05	0.25				
Queue Length 95th (m)	0.4	0.0	0.4	0.0	6.4	4.0	1.2	7.6				
Control Delay (s)	8.0	0.0	8.3	0.0	28.2	17.4	21.2	18.4				
Lane LOS	A		A		D	C	C	C				
Approach Delay (s)	0.4		0.4		22.4		18.7					
Approach LOS					C		C					
Intersection Summary												
Average Delay			4.0									
Intersection Capacity Utilization			38.5%		ICU Level of Service			A				
Analysis Period (min)			15									

HCM Unsignalized Intersection Capacity Analysis
102: Clover Ave. & Wyandotte St.

Saturday Peak Hour
2032 Total Future Conditions

												
Movement	EBL	EBT	EBR	WBL	WBT	WBR	NBL	NBT	NBR	SBL	SBT	SBR
Lane Configurations												
Traffic Volume (veh/h)	10	350	40	5	295	20	35	75	10	25	130	15
Future Volume (Veh/h)	10	350	40	5	295	20	35	75	10	25	130	15
Sign Control		Free			Free			Stop			Stop	
Grade		0%			0%			0%			0%	
Peak Hour Factor	0.92	0.92	0.92	0.92	0.92	0.92	0.92	0.92	0.92	0.92	0.92	0.92
Hourly flow rate (vph)	11	380	43	5	321	22	38	82	11	27	141	16
Pedestrians												
Lane Width (m)												
Walking Speed (m/s)												
Percent Blockage												
Right turn flare (veh)												
Median type		None			None							
Median storage veh												
Upstream signal (m)												
pX, platoon unblocked												
vC, conflicting volume	343			423			841	776	402	796	787	332
vC1, stage 1 conf vol												
vC2, stage 2 conf vol												
vCu, unblocked vol	343			423			841	776	402	796	787	332
tC, single (s)	4.1			4.1			7.1	6.5	6.2	7.1	6.5	6.2
tC, 2 stage (s)												
tF (s)	2.2			2.2			3.5	4.0	3.3	3.5	4.0	3.3
p0 queue free %	99			100			79	75	98	89	56	98
cM capacity (veh/h)	1216			1136			180	324	649	239	319	710
Direction, Lane #	EB 1	EB 2	WB 1	WB 2	NB 1	NB 2	SB 1	SB 2				
Volume Total	11	423	5	343	38	93	27	157				
Volume Left	11	0	5	0	38	0	27	0				
Volume Right	0	43	0	22	0	11	0	16				
cSH	1216	1700	1136	1700	180	344	239	338				
Volume to Capacity	0.01	0.25	0.00	0.20	0.21	0.27	0.11	0.46				
Queue Length 95th (m)	0.2	0.0	0.1	0.0	6.1	8.6	3.0	18.8				
Control Delay (s)	8.0	0.0	8.2	0.0	30.2	19.3	22.0	24.5				
Lane LOS	A		A		D	C	C	C				
Approach Delay (s)	0.2		0.1		22.5		24.2					
Approach LOS					C		C					
Intersection Summary												
Average Delay			6.9									
Intersection Capacity Utilization			41.9%		ICU Level of Service			A				
Analysis Period (min)			15									